

# CATALOGUE

PLASTIC GAS FLUE SYSTEMS

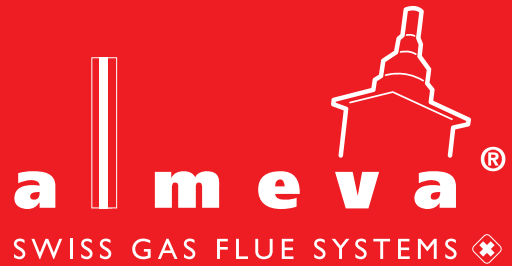

# KATALOG

KUNSTSTOFF-ABGASSYSTEME

# CATÁLOGO

SISTEMAS SINTÉTICOS DE EVACUACIÓN DE GASES

# KATALOG

GAZ BACA SISTEMI

# ΚΑΤΑΛΟΓΟΣ

ΣΥΣΤΗΜΑΤΑ ΚΑΠΝΟΔΟΧΩΝ ΣΥΜΠΥΚΝΩΜΑΤΩΝ

**SAPI** X  
KAMIN-SYSTEM

# The **innovation** in flexible gas flue systems

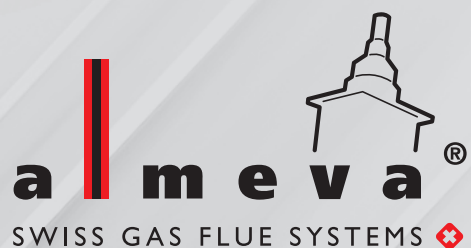
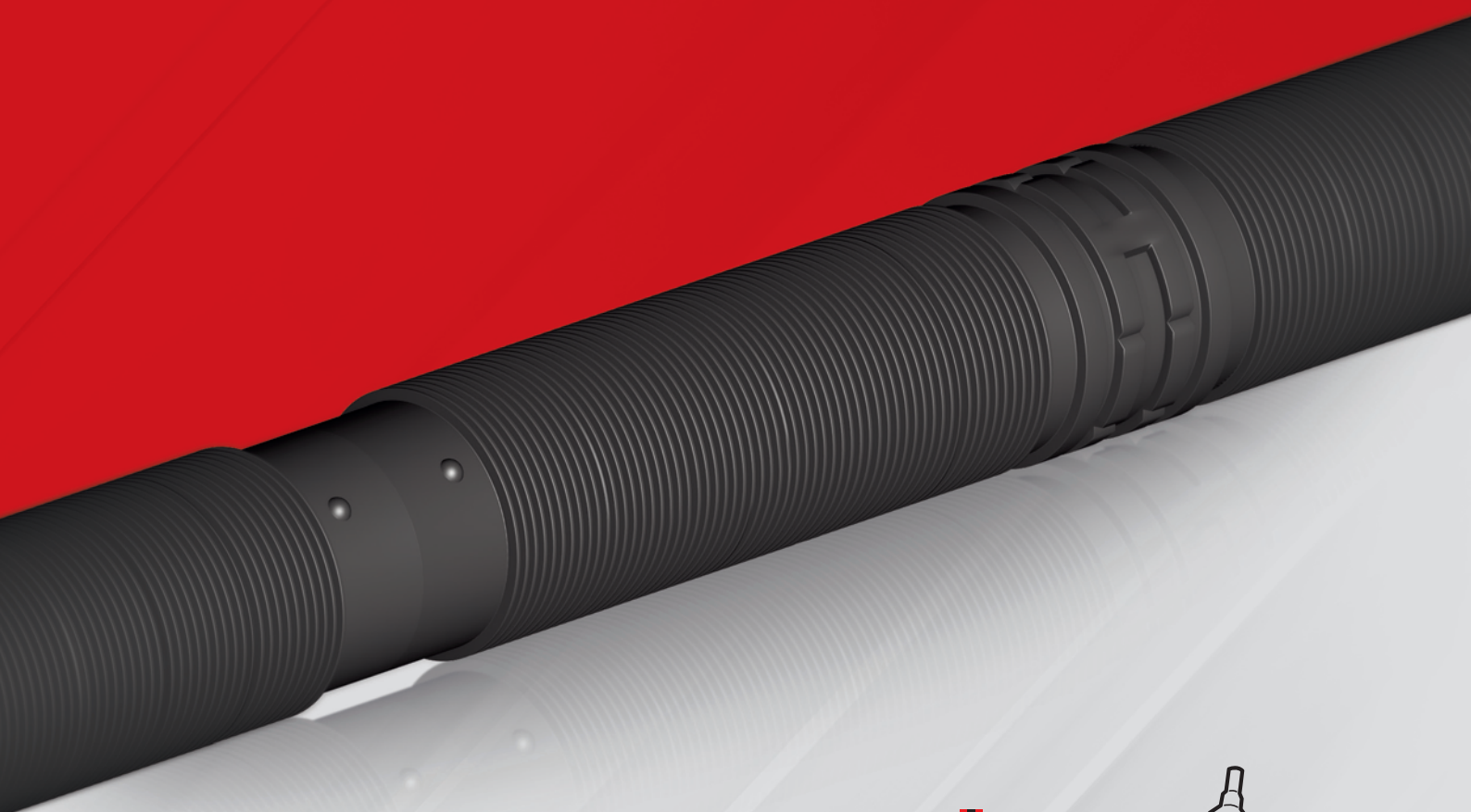

The widest assortment of gas flue system components

# Index of contents

<b>Gas flue system ALMEVA</b>	Basic system characteristics	8	<b>ALMEVA</b>
	Summary of sub-systems and their elements	9	
	Marking system elements	10	
	Material	11	
<b>Rigid gas flue system (STARR) PPH – black Ø60 – 315 mm</b>	System structure	28	<b>STARR</b>
	Assembly instructions	29-30	
	System elements	31-47	
<b>Flexible gas flue system (FLEX) PPH Ø60 – 200 mm</b>	System structure	48	<b>FLEX</b>
	Assembly instructions	49	
	System elements	50-56	
<b>Internal concentric air-gas flue system (LIK) PPH/PPH – white Ø60/100 – 80/125 mm</b>	System structure	58	<b>LIK</b>
	Assembly instructions	59	
	System elements	60-68	
<b>Internal concentric air-gas flue system (LIL, LIB) LIL – PPH/stainless steel – white powder coated LIB – PPH/stainless steel – polished Ø60/100 – 200/300 mm</b>	System structure LIL	70	<b>LIL</b>
	Assembly instructions LIL	71	
	System structure LIB	72	
	Assembly instructions LIB	73	
	System elements LIL/LIB	74-85	
<b>External concentric air-gas flue system (LAB, LAL) LAB – PPH/stainless steel – polished LAL – PPH/stainless steel – white powder coated Ø60/100 – 200/300 mm</b>	System structure LAB	86	<b>LAB</b>
	Assembly instructions LAB	87	
	System structure LAL	88	
	Assembly instructions LAL	89	
	System elements LAB/LAL	90-96	
<b>External concentric air-gas flue system (LAC, LAM) LAC – PPH/stainless steel – copper coated Ø60/100 – 110/160 mm LAM – PPH/stainless steel – matt Ø60/100 – 200/300 mm</b>	System structure LAC	100	<b>LAC</b>
	Assembly instructions LAC	101	
	System structure LAM	102	
	Assembly instructions LAM	103	
	System elements LAC/LAM	104-110	
<b>External concentric air-gas flue system (LAS) PPH (black) - Variant 1 Ø60 – 315 with branch 87° Ø60 – 250 mm PPH/stainless steel white powder coated or PPH/stainless steel polished - Variant 2 Ø80/125 – 200/300 with branch 87° Ø60/100 and 80/125 mm PPH/stainless steel polished - Variant 3 Ø110/160 – 200/300 mm with branch 87° Ø60/100 and 80/125 mm</b>	System structure Variant 1	114	<b>LAS</b>
	System elements Variant 1	115-117	
	System structure Variant 2	118	
	System elements Variant 2	119-121	
	System structure Variant 3	122	
<b>Gas flue system for cascade application (CAS) PPH (black) - Variant 1 Ø80 – 315 with branch 45°, 87° Ø60 – 250 mm PPH/stainless steel white powder coated - Variant 2 Ø110/160 – 200/300 mm with branch 87° Ø60/100 and 80/125 mm</b>	System structure Variant 1	126	<b>CAS</b>
	Assembly instructions Variant 1	127	
	System elements Variant 1	128-131	
	System structure Variant 2	132	
	System elements Variant 2	133-135	
<b>Accessories (ZUB)</b>	Accessories	136-143	<b>ZUB</b>
<b>Other information (SI)</b>	Declaration of performance, Chimney tag EU	144	<b>SI</b>
	Certificate	149	

# Inhalt

<b>ALMEVA</b>	<b>Kunststoff-Abgassysteme Almeva</b>	Hauptcharakteristiken des Systems Übersicht über die Systeme und die Elemente der Systeme Kennzeichnungen der Systemelemente Material	12 13 14 15
<b>STARR</b>	<b>Starres Abgassystem (STARR)</b> PPH – schwarz Ø60 – 315 mm	Systemaufbau Montagehinweise Systemelemente	28 29-30 31-47
<b>FLEX</b>	<b>Flexibles Abgassystem (FLEX)</b> PPH Ø60 – 200 mm	Systemaufbau Montagehinweise Systemelemente	48 49 50-56
<b>LIK</b>	<b>Konzentrisches Luft-Abgassystem (LIK)</b> PPH/PPH – weiss Ø60/100 – 80/125 mm	Systemaufbau Montagehinweise Systemelemente	58 59 60-68
<b>LIL</b>	<b>Konzentrisches Luft-Abgassystem (LIL, LIB)</b> LIL – PPH/Edelstahl weiss pulverbeschichtet LIB – PPH/Edelstahl hochglanz Ø60/100 – 200/300 mm	Systemaufbau LIL	70
<b>LIB</b>		Montagehinweise LIL Systemaufbau LIB Montagehinweise LIB Systemelemente LIL/LIB	71 72 73 74-85
<b>LAB</b>	<b>Konzentrisches Aussenwandssystem (LAB, LAL)</b> LAB – PPH/Edelstahl hochglanz LAL – PPH/Edelstahl weiss pulverbeschichtet Ø60/100 – 200/300 mm	Systemaufbau LAB	86
<b>LAL</b>		Montagehinweise LAB Systemaufbau LAL Montagehinweise LAL Systemelemente LAB/LAL Montagehinweise LAB/LAL	87 88 89 90-96 97-99
<b>LAC</b>	<b>Konzentrisches Aussenwandssystem (LAC, LAM)</b> LAC – PPH/Edelstahl kupferbeschichtet Ø60/100 – 110/160 mm LAM – PPH/Edelstahl matt Ø60/100 – 200/300 mm	Systemaufbau LAC	100
<b>LAM</b>		Montagehinweise LAC Systemaufbau LAM Montagehinweise LAM Systemelemente LAC/LAM Montagehinweise LAC/LAM	101 102 103 104-110 111-113
<b>LAS</b>	<b>Luft-Abgassystem für Mehrfachbelegung (LAS)</b> PPH (schwarz) – Variante 1 Ø60 – 315 mit Abzweiger 87° Ø60 – 250 mm PPH/Edelstahl weiss pulverbeschichtet oder PPH/Edelstahl hochglanz – Variante 2 Ø80/125 – 200/300 mit Abzweiger 87° Ø60/100 und 80/125 mm PPH/Edelstahl hochglanz – Variante 3 Ø110/160 – 200/300 mm mit Abzweiger 87° Ø60/100 und 80/125 mm	Systemaufbau – Variante 1 Systemelemente – Variante 1 Systemaufbau – Variante 2 Systemelemente – Variante 2 Systemaufbau – Variante 3 Systemelemente – Variante 3	114 115-117 118 119-121 122 123-125
<b>CAS</b>	<b>Abgassystem für Kaskade (CAS)</b> PPH (schwarz) – Variante 1 Ø80 – 315 mit Abzweiger 45°, 87° Ø60 – 250 mm PPH/Edelstahl weiss pulverbeschichtet – Variante 2 Ø110/160 – 200/300 mm mit Abzweiger 87° Ø60/100 und 80/125 mm	Systemaufbau – Variante 1 Montagehinweise – Variante 1 Systemelemente – Variante 1 Systemaufbau – Variante 2 Systemelemente – Variante 2	126 127 128-131 132 133-135
<b>ZUB</b>	<b>Zubehör (ZUB)</b>	Zubehörelemente	136-143
<b>SI</b>	<b>Sonstige Information (SI)</b>	Leistungserklärung Zertifikat	145 149

# Índice

<b>Sistemas sintéticos de evacuación de gases ALMEVA</b>	Características principales del sistema	16	<b>ALMEVA</b>
	Resumen de los sistemas y sus componentes	17	
	Marcado de los elementos del sistema	18	
	Material	19	
<b>Sistema de evacuación para el interior - Rígido (STARR)</b> PPH – negro Ø60 – 315 mm	Estructura del sistema	28	<b>STARR</b>
	Instrucciones de montaje	29-30	
	Componentes	31-47	
<b>Sistema de evacuación para el interior - Flexible (FLEX)</b> PPH Ø60 – 200 mm	Estructura del sistema	48	<b>FLEX</b>
	Instrucciones de montaje	49	
	Componentes	50-56	
<b>Sistema de evacuación concéntrico para el interior (LIK)</b> PPH/PPH – blanco Ø60/100 – 80/125 mm	Estructura del sistema	58	<b>LIK</b>
	Instrucciones de montaje	59	
	Componentes	60-68	
<b>Sistema de evacuación concéntrico para el interior (LIL, LIB)</b> LIL – PPH/acero inoxidable en epoxi blanco LIB – PPH/acero inoxidable pulido Ø60/100 – 200/300 mm	Estructura del sistema LIL	70	<b>LIL</b>
	Instrucciones de montaje LIL	71	
	Estructura del sistema LIB	72	
	Instrucciones de montaje LIB	73	
	Componentes LIL/LIB	74-85	
<b>Sistema de evacuación concéntrico para el exterior (LAB, LAL)</b> LAB – PPH/acero inoxidable pulido LAL – PPH/acero inoxidable en epoxi blanco Ø60/100 – 200/300 mm	Estructura del sistema LAB	86	<b>LAB</b>
	Instrucciones de montaje LAB	87	
	Estructura del sistema LAL	88	
	Instrucciones de montaje LAL	89	
	Componentes LAB/LAL	90-96	
<b>Sistema de evacuación concéntrico para el exterior (LAC, LAM)</b> LAC – PPH/acero inoxidable cobreado Ø60/100 – 110/160 mm LAM – PPH/acero inoxidable mate Ø60/100 – 200/300 mm	Estructura del sistema LAC	100	<b>LAC</b>
	Instrucciones de montaje LAC	101	
	Estructura del sistema LAM	102	
	Instrucciones de montaje LAM	103	
	Componentes LAC/LAM	104-110	
<b>Sistemas de evacuación para aplicación en Comunidad (LAS)</b> PPH (negro) – Variante 1 Ø60 – 315 con codos 87° Ø60 – 250 mm PPH/acero inoxidable en epoxi blanco o PPH/acero inoxidable pulido – Variante 2 Ø80/125 – 200/300 con codos 87° Ø60/100 y 80/125 mm PPH/acero inoxidable pulido – Variante 3 Ø110/160 – 200/300 mm con codos 87° Ø60/100 y 80/125 mm	Estructura del sistema – Variante 1	114	<b>LAS</b>
	Componentes – Variante 1	115-117	
	Estructura del sistema – Variante 2	118	
	Componentes – Variante 2	119-121	
	Estructura del sistema – Variante 3	122	
<b>Sistemas de evacuación para aplicación en Cascada (CAS)</b> PPH (negro) – Variante 1 Ø80 – 315 con codos 45°, 87° Ø60 – 250 mm PPH/acero inoxidable en epoxi blanco – Variante 2 Ø110/160 – 200/300 mm con codos 87° Ø60/100 y 80/125 mm	Estructura del sistema – Variante 1	126	<b>CAS</b>
	Instrucciones de montaje – Variante 1	127	
	Componentes – Variante 1	128-131	
	Estructura del sistema – Variante 2	132	
	Componentes – Variante 2	133-135	
<b>Accesorios (ZUB)</b>	Accesorios	136-143	<b>ZUB</b>
<b>Otras informaciones (SI)</b>	Declaración de conformidad	146	<b>SI</b>
	Información del producto	149	

# İçindekiler indeksi

<b>ALMEVA</b>	<b>Gas flue system ALMEVA</b>	Temel sistem özellikleri Alt sistemlerin özeti Gaz baca sistemi ALMEVA ve elemanları İşaretleme sistemi elemanları	8 9 10 11
<b>STARR</b>	<b>Sert gaz baca sistemi (STARR)</b> PPH - siyah Ø60 - 315 mm	Sistem yapısı Montaj talimatları Sistem elemanları	28 29-30 31-47
<b>FLEX</b>	<b>Esnek gaz baca sistemi (FLEX)</b> PPH Ø60 - 200 mm	Sistem yapısı Montaj talimatları Sistem elemanları	48 49 50-56
<b>LIK</b>	<b>Dahili konsantrik hava-gaz baca sistemi (LIK)</b> PPH/PPH - beyaz Ø60/100 - 80/125 mm	Sistem yapısı Montaj talimatları Sistem elemanları	58 59 60-68
<b>LIL</b>	<b>Dahili eş merkezli hava-gaz baca sistemi (LIL, LIB)</b> LIL - PPH/paslanmaz çelik - beyaz toz boyalı LIB - PPH/paslanmaz çelik - cilalı Ø60/100 - 200/300 mm	Sistem yapısı LIL Montaj talimatları LIL Sistem yapısı LIB Montaj talimatları LIB Sistem elemanları LIL/LIB	70 71 72 73 74-85
<b>LAB</b>	<b>Harici konsantrik hava-gaz baca sistemi (LAB, LAL)</b> LAB - PPH/paslanmaz çelik - cilalı LAL - PPH/paslanmaz çelik - beyaz toz boyalı Ø60/100 - 200/300 mm	Sistem yapısı LAB Montaj talimatları LAB Sistem yapısı LAL Montaj talimatları LAL Sistem elemanları LAB/LAL Montaj talimatları LAB/LAL	86 87 88 89 90-96 97-99
<b>LAC</b>	<b>Harici konsantrik hava-gaz baca sistemi (LAC, LAM)</b> LAC - PPH/paslanmaz çelik - bakır kaplı Ø60/100 - 110/160 mm LAM - PPH/paslanmaz çelik - mat Ø60/100 - 200/300 mm	Sistem yapısı LAC Montaj talimatları LAC Sistem yapısı LAM Montaj talimatları LAM Sistem elemanları LAC/LAM Montaj talimatları LAC/LAM	100 101 102 103 104-110 111-113
<b>LAS</b>	<b>Topluluk uygulaması için gaz baca sistemi (LAS)</b> PPH (siyah) - Varyant 1 Ø80 - 315, 87° dal ile Ø60 - 250 mm PPH/paslanmaz çelik - beyaz toz boyalı veya PPH/paslanmaz çelik - cilalı - Varyant 2 Ø80/125 - 20/300, 87° dal ile Ø60/100 - 80/125 mm PPH/paslanmaz çelik - cilalı - Varyant 3 Ø110/160 - 20/300, 87° dal ile Ø60/100 - 80/125 mm	Sistem yapısı Varyant 1 Sistem elemanları Varyant 1 Sistem yapısı Varyant 2 Sistem elemanları Varyant 2 Sistem yapısı Varyant 3 Sistem elemanları Varyant 3	114 115-117 118 119-121 122 123-125
<b>CAS</b>	<b>Kaskad uygulaması için gaz baca sistemi (CAS)</b> PPH (siyah) - Varyant 1 Ø80 - 315 45°, 87° dal ile Ø60 - 250 mm PPH/paslanmaz çelik beyaz toz boyalı - Varyant 2 Ø110/160 - 200/300 mm, 87° Ø60/100 ve 80/125 mm bransman ile	Sistem yapısı Varyant 1 Montaj talimatları Varyant 1 Sistem elemanları Varyant 1 Sistem yapısı Varyant 2 Sistem elemanları Varyant 2	126 127 128-131 132 133-135
<b>ZUB</b>	<b>Aksesuarlar (ZUB)</b>	Aksesuarlar	136-143
<b>SI</b>	<b>Diğer bilgiler (SI)</b>	Performans beyanı Baca etiketi EU Sertifika	147 149

# Κατάλογος περιεχομένων

<b>Σύστημα καπνοδόχου ALMEVA</b>	Βασικά χαρακτηριστικά του συστήματος Υποσυστήματα και τα στοιχεία τους Σήμανση στοιχείων του συστήματος Υλικά	24 25 26 27	<b>ALMEVA</b>
<b>Άκαμπτο σύστημα καπνοδόχου (STARR) PPH Ø60 – 315 mm</b>	Δομή συστήματος Οδηγίες εγκατάστασης Υλικά συστήματος	28 29-30 31-47	<b>STARR</b>
<b>Εύκαμπτο σύστημα καπνοδόχου (FLEX) PPH Ø60 – 200 mm</b>	Δομή συστήματος Οδηγίες εγκατάστασης Υλικά συστήματος	48 49 50-56	<b>FLEX</b>
<b>Ομοκεντρικό σύστημα καπνοδόχου εσωτερικής χρήσης (LIK) PPH/PPH – λευκό Ø80/125 mm</b>	Δομή συστήματος Οδηγίες εγκατάστασης Υλικά συστήματος	58 59 60-68	<b>LIK</b>
<b>Ομοκεντρικό σύστημα καπνοδόχου εσωτερικής χρήσης (LIL, LIB) LIL – PPH/χάλυβας με ηλεκτροστατική βαφή LIB – PPH/ανοξειδωτος χάλυβας Ø60/100 – 200/300 mm</b>	Δομή συστήματος LIL Οδηγίες εγκατάστασης LIL Δομή συστήματος LIB Οδηγίες εγκατάστασης LIB Υλικά συστήματος LIL/LIB	70 71 72 73 74-85	<b>LIL</b> <b>LIB</b>
<b>Ομοκεντρικό σύστημα καπνοδόχου εσωτερικής χρήσης (LAB, LAL) LAB – PPH/ανοξειδωτος χάλυβας LAL – PPH/ανοξειδωτος χάλυβας με ηλεκτροστατική βαφή Ø60/100 – 200/300 mm</b>	Δομή συστήματος LAB Οδηγίες εγκατάστασης LAB Δομή συστήματος LAL Οδηγίες εγκατάστασης LAL Υλικά συστήματος LAB/LAL Οδηγίες εγκατάστασης LAB/LAL	86 87 88 89 90-96 97-99	<b>LAB</b> <b>LAL</b>
<b>Ομοκεντρικό σύστημα καπνοδόχου εσωτερικής χρήσης (LAC, LAM) LAC – PPH/ανοξειδωτος χάλυβας – χαλκός Ø60/100 – 110/160 mm LAM – PPH/ανοξειδωτος χάλυβας – ματ Ø60/100 – 200/300 mm</b>	Δομή συστήματος LAC Οδηγίες εγκατάστασης LAC Δομή συστήματος LAM Οδηγίες εγκατάστασης LAM Υλικά συστήματος LAC/LAM Οδηγίες εγκατάστασης LAC/LAM	100 101 102 103 104-110 111-113	<b>LAC</b> <b>LAM</b>
<b>Σύστημα καπνοδόχου πολλαπλής σύνδεσης συσκευών που δεν εξαρτώνται από τον αέρα καύσης του χώρου, τύπου “C” (LAS) PPH – Παραλλαγή 1 Ø60 – 315 με διακλάδωση 87° Ø60 – 250 mm PPH/χάλυβας με ηλεκτροστατική βαφή ή PPH/ανοξ. χάλυβας – Παραλλαγή 2 Ø80/125 – 200/300 με διακλάδωση 87° Ø60/100, 80/125 mm PPH/ανοξειδωτος χάλυβας – Παραλλαγή 3 Ø110/160 – 200/300 mm με διακλάδωση 87° Ø60/100, 80/125 mm</b>	Δομή συστήματος – Παραλλαγή 1 Υλικά συστήματος – Παραλλαγή 1 Δομή συστήματος – Παραλλαγή 2 Υλικά συστήματος – Παραλλαγή 2 Δομή συστήματος – Παραλλαγή 3 Υλικά συστήματος – Παραλλαγή 3	114 115-117 118 119-121 122 123-125	<b>LAS</b>
<b>Σύστημα καπνοδόχων για συσκευές σε συστοιχία, cascade (CAS) PPH – Παραλλαγή 1 Ø80 – 315 mm με διακλάδωση 45°, 87° Ø60 – 250 mm PPH/ανοξειδωτος χάλυβας με ηλεκτροστατική βαφή – Παραλλαγή 2 Ø110/160 – 200/300 mm με διακλάδωση 87° Ø60/100, 80/125 mm</b>	Δομή συστήματος – Παραλλαγή 1 Οδηγίες εγκατάστασης – Παραλλαγή 1 Υλικά συστήματος – Παραλλαγή 1 Δομή συστήματος – Παραλλαγή 2 Υλικά συστήματος – Παραλλαγή 2	126 127 128-131 132 133-135	<b>CAS</b>
<b>Εξαρτήματα (ZUB)</b>	Υλικά συστήματος	136-143	<b>ZUB</b>
<b>Λοιπές πληροφορίες (SI)</b>	Δήλωση πιστοποίησης Πιστοποιητικό	148 149	<b>SI</b>

# PLASTIC GAS FLUE SYSTEMS ALMEVA

## MAIN FEATURES OF THE SYSTEM

ALMEVA

### Advantages

The Almeva gas flue system is a modern and advanced chimney system. Years of continuous development have resulted in a range of high quality, precision pipes, moulded parts and accessories. The precise shape of the socket joints enables excellent pneumatic properties of the pipes, which guarantees a perfect flow of the flue gases.

Elastomeric seals ensure that the couplings are tight. These seals guarantee an excellent and immediate sealing force, a high resistance power, but also a durable flexibility of the connections: the installation is easy and fast. As a result, chimney and heating installation companies are able to work highly efficiently building and installing new chimneys or renovating existing units.

### Use according to the heat source

- the system is intended for flue gas discharge from condensing and low temperature boilers with a maximum flue gas temperature at the boiler of 120°C
- the system is primarily intended for use in overpressure mode (the pressure inside the flue gas system is higher than outside)
- the system is not soot fire resistant
- the system is intended for flues used for wet operation
- the system can only be used for heating systems in which gaseous fuels or natural gas (L, H) and liquid fuels (LTO with a sulphur content  $\leq 0.2\%$ , paraffin) are burnt

### Use according to the place of installation

- for new installation (assembly) of flue gas systems
- for the renovation of existing systems
- suitable systems can be installed in indoor and outdoor areas

### System components

The Almeva flue system has many components that are irreplaceable as part of functional modern flue systems. There are more than 200 elements, each in different dimensions, making a total of more than 2250 catalogued items that form a complex flue system.

Almeva offers the largest range in the field of plastic flues with guaranteed quality.

# PLASTIC GAS FLUE SYSTEMS ALMEVA

## OVERVIEW OF THE SYSTEMS AND THEIR ELEMENTS

### The Almeva range offers various gas flue systems

ALMEVA

#### **STARR**

Composed of rigid pipes and molded pieces in PPH, Ø60 – 315 mm and accessories, for indoor installation and assembly in rectilinear ascension, connections with sockets and EPDM seals.

#### **FLEX**

Composed of flexible pipes and molded pieces in PPH, Ø60 – 200mm and accessories, especially recommended for the assembly of straight and stepped ascension tubes, connections with union nuts and EPDM seals.

#### **LIK**

Composed of concentric rigid pipes and molded pieces in PPH/PPH, Ø60/100 – 80/125mm, for indoor installation, connections with sockets and EPDM seals.

#### **LIL**

Composed of concentric rigid pipes and molded pieces in PPH/stainless steel in white epoxy, Ø60/100 – 200/300mm, for indoor installation, connections with sockets and EPDM seals.

#### **LIB**

Composed of concentric rigid pipes and molded pieces in PPH/stainless steel polished, Ø60/100 – 200/300mm, for indoor installation, connections with sockets and EPDM seals.

#### **LAB**

Composed of concentric rigid pipes and molded pieces in PPH/stainless steel polished, Ø60/100 – 200/300mm, for outdoor installation, connections with conical connectors.

#### **LAL**

Composed of concentric rigid pipes and molded pieces in PPH/stainless steel in white epoxy, Ø60/100 – 200/300mm, for outdoor installation, connections with conical connectors.

#### **LAC**

Composed of concentric rigid pipes and molded pieces in PPH/stainless steel copper coated, Ø60/100 – 110/160mm, for outdoor installation, connections with conical connectors.

#### **LAM**

Composed of concentric rigid pipes and molded pieces in PPH/stainless steel matt, Ø60/100 – 200/300mm, for outdoor installation, connections with conical connectors.

#### **LAS**

Composed of rigid pipes in PPH, Ø80 – 315 mm, with branch 87° Ø60 – 250 mm (Var. 1), concentric rigid pipes in PPH/stainless steel polished - stainless steel in white epoxy Ø80/125 – 200/300 mm, with branch 87° Ø60/100 – 80/125 mm (Var. 2), concentric rigid pipes in PPH/stainless steel polished Ø110/160V200/300 mm, with branch 87° Ø60/100 – 80 125 mm (Var. 3) and accessories, designed to connect several boilers to a common chimney in indoors (Var. 2) and also outdoors (Var. 3). Connections with sockets and EPDM seals.

#### **CAS**

Composed of rigid pipes and molded pieces in PPH, Ø80 – 315 mm, with branch 45°, 87° Ø60 – 250 mm (Var.1), PPH/stainless steel white powder coated Ø110/160 – 200/300 mm with branch 87° Ø60/100 and 80/125 mm (Var.2), and accessories, suitable for cascade installation indoors, connections with sockets and EPDM seals.

#### **ZUB**

Accessories for chimney systems (neutroboxes, clips, clean-out door, condensate pumps, etc.).

# PLASTIC GAS FLUE SYSTEMS ALMEVA

## MARKING OF SYSTEM ELEMENTS

ALMEVA

All chimney parts of the Almeva system are classified according to EN 1443 which regulates the general requirements and basic operating conditions for chimney systems and marked according to EN 14471 which specifies the properties of plastic gas flue systems. The pipes are normally marked by printing situated in line with all required data. Each individual component contains so-called „identification mark“ (summary of the required data pressed on the socket).

The entire system and all system components are certified and bear the CE mark. This is in accordance with Directive 93/68/EC and is marked with the certification number 0036 CPD 9165 001 on labels on the individual components.

Every chimney must be marked with a corresponding label. This label identifies the gas flue system according to standards.

The label must be indelible and clearly legible, made of durable material and affixed in a visible place. It contains the company name or trademark of the manufacturer, the classification according to EN 14471, the nominal diameter and heat resistance of the gas flue system, information on the manufacturer and type of boiler, the total output of the system, information on the installation company (address, telephone number, etc.), the date of installation and the number of the inspection report.

### Example of pipe marking:

Almeva PP NW 80x2.2 Z-7.2-3I28 TÜV/VKF Nr. Z 14700 /TI20 PI W 2 O-20 R00 E100/Charge 07 053

### Example of molded pieces marking:

Almeva PP  
T120;P1;W;2;O-20  
R00; E1 00 (bb)  
Z-7.2-3I28 TÜV  
VKF Nr. Z 14700

### Chimney tag EU:

		<b>Almeva AG</b> Industriestrasse 6 CH-9220 Bischofszell Switzerland Tel.: +41 71 644 90 20 Fax: +41 71 644 90 29 www.almeva.ch E-mail: info@almeva.ch	
One-layer system chimney <b>EN 14471</b> O T120 - P1 - O - W - 2 - O20 - LI - E - U  <b>EN 1443</b> T120 H1/P1 W 2 O20 E100		Two-layer system chimney <b>EN 14471</b> O T120 - P1 - O - W - 2 - O00 - LI - E - U1 O T120 - P1 - O - W - 2 - O00 - LI - E - U0 O T120 - P1 - O - W - 2 - O00 - LE - E - U0  <b>EN 1443</b> T120 H1/P1 W 2 O00 E100	
Chimney heat resistance 0,00 m <sup>2</sup> .K.W <sup>-1</sup>			
Rated diameter mm		Rated diameter mm	
Manufacturer and type of appliances:			
Gross power of appliances:			
Assembly organization, address, tel:			
Date of installation:			
Number of inspection report:			
<b>NOTE:</b> Chimney tag must be visibly mounted on combustion gas routes Almeva, always visible, may not be painted over, removed or otherwise damaged!			

# PLASTIC GAS FLUE SYSTEMS ALMEVA

## MATERIAL

### Plastic rigid pipes, flexible pipes and moulded parts

The raw material of manufacture is polypropylene homopolymer (PPH). It is a partially crystalline, high molecular weight thermoplastic material with a density significantly lower than that of other plastics used in the industry, ranging from 0.90 to 0.91 g.cm<sup>3</sup>. PPH is very weldable. The surface is not soluble and does not swell. It is very resistant to ageing, so that the system elements are characterised by a very long service life.

PPH has excellent resistance to acids (except oxidising acids), alkalis and light solvents. It has a high resistance to weathering and microbes. It is physiologically neutral. Compared to other conventional plastics, PPH has a very good surface hardness and sufficient flexibility even at low temperatures.

PPH is also characterised by good impact resistance, good electrical insulation properties with almost zero condensate absorption capacity and high temperature resistance (even at 140°C for a short period of time). It has a very low thermal conductivity (only 0.22W/mK), which means that during operation the temperature of the flue gases in the pipes does not drop as much as e.g. with stainless steel. PPH belongs to the group of thermoplastics and therefore retains its excellent properties after heating and re-cooling. PPH pipes in black are UV-protected according to EN ISO 8256:2004.

### Sealing gaskets

The sealing gaskets and other system joints are made of ethylene propylene diene rubber (EPDM) and are inserted into all pipes and factory moulded parts. It is a high quality elastomer with long-term resistance to condensation and high temperatures (it can briefly withstand up to 150°C). It is resistant to ageing, oxidation, ozone and weathering. This acid-resistant rubber also resists chemicals such as inorganic materials (including carbon dioxide) and polar organic compounds very well. However, EPDM shows little resistance to crude oils, so direct contact with petroleum fats and oils should be avoided.

### Outer coating and anchoring elements

The outer coating of the LIB, LAB and LAM systems and their anchoring elements are made of stainless steel alloy no. 1.4301 (marked according to EN ISO X5CrNi 18-10). This chromium-nickel stainless steel is easy to weld and polish and has a high elasticity. It is abrasion resistant, easily recyclable and has a long-term temperature resistance of up to 300°C. The steel is resistant to water, steam, air humidity and weak organic and inorganic acids.

The LAC system is made of the same materials as the LIB and LAB systems. It is also coated with galvanic copper, which guarantees the same aesthetic surface as pure copper.

The outer coating of the LIL, LAL systems and their anchoring elements are made of stainless steel No. 1.4509 (marked according to EN ISO X3CrTi17). This stainless steel is suitable for cold forming and the surface can be painted, metallised or enamelled. Due to these characteristics, the surfaces of all components of the LIL and LAL systems are coated with white epoxy powder paint. Due to the corrosion resistance of the material, the powder coating is purely for aesthetic purposes.

# KUNSTSTOFF-ABGASSYSTEME ALMEVA

## HAUPTCHARAKTERISTIKEN DES SYSTEMS

ALMEVA

### Vorteile

Beim Almeva-Abgas-System handelt es sich um ein modernes ausgereiftes Produkt, bei dem durch jahrelange Weiterentwicklung hohe Präzision und Qualität der Rohre, Formstücke und des übrigen Zubehörs erreicht worden ist. Die präzise Form der Muffenverbindungen ermöglicht ausgezeichnete pneumatische Eigenschaften der Rohrleitungen, was eine perfekte Strömung der Rauchgase garantiert.

Die Muffenverbindungen werden mit Elastomerringen abgedichtet. Die Ringe garantieren eine sofortige ausgezeichnete Dichtigkeit, Festigkeit aber auch eine langfristige Flexibilität der Verbindungen und beschleunigen und erleichtern den Einbau.

Die Einfachheit der Verbindungstechnik ermöglicht eine schnelle Montage der Systeme. Dadurch sind Kamin- und Heizungsbaufirmen in der Lage, bei neuen Abgasanlagen wie auch bei Sanierungen hoch effizient zu arbeiten.

### Einsatz hinsichtlich der Wärmequelle

- das System dient zur Abführung von Rauchgasen aus Kondensations- und Niedertemperaturkesseln mit maximaler Rauchgastemperatur am Heizkessel von 120°C
- das System ist vor allem für Überdruckbetrieb bestimmt (der Druck im Inneren des Abgassystems ist bei Betrieb höher als aussen). Das System kann auch für Unterdruckbetrieb verwendet werden.
- das System ist nicht gegen Russbrand beständig
- das System ist für Abgasleitungen bestimmt, die für nassen Betrieb genutzt werden
- das System kann nur für Heizsysteme eingesetzt werden, in denen gasförmige Brennstoffe bzw. Erdgas (L, H) und flüssige Brennstoffe (LTO mit einem Schwefelanteil  $\leq 0,2\%$ , Kerosin) verbrannt werden

### Einsatz hinsichtlich des Installationsortes

- für den Neubau (Montage) von Abgassystemen
- für Sanierungen vorhandener Abgassysteme
- die entsprechenden Systeme können im Haus und im Aussenbereich eingesetzt werden

### Systemelemente

Das Abgassystem Almeva verfügt über viele Komponenten, die als Bestandteil funktionsfähiger moderner Abgasführungen unersetzbar sind. Es handelt sich um mehr als 200 Elemente, jedes in verschiedenen Abmessungen, insgesamt also um mehr als 2250 katalogisierte Artikel, die ein komplexes Abgassystem bilden.

Almeva bietet das grösste Sortiment im Bereich Abgasleitungen aus Kunststoff mit garantierter Qualität.

## ÜBERSICHT ÜBER DIE SYSTEME UND DIE ELEMENTE DER SYSTEME

### Das Angebot von Almeva setzt sich aus mehreren Abgassystemen zusammen

**STARR**

bestehend aus starren Rohren und Formstücken aus PPH, Ø60 – 315 mm und Zubehör, geeignet vor allem für Innenräume und zum Bestücken von geraden Steigleitungen, Verbindung mit Muffen und EPDM-Dichtungen.

**FLEX**

bestehend aus flexiblen Schläuchen und Formstücken aus PPH, Ø60 – 200 mm und Zubehör, geeignet vor allem zum Bestücken von geraden und etagierten Steigleitungen, Verbindung mit Überwurfmutter und EPDM-Dichtungen.

**LIK**

bestehend aus starren konzentrischen Rohren und Formstücken aus PPH/PPH, Ø60/100 – 80/125 mm, geeignet für Abgassysteme im Innenbereich, Verbindung mit Muffen und EPDM-Dichtungen.

**LIL**

bestehend aus starren konzentrischen Rohren und Formstücken aus PPH/pulverbeschichtetem Edelstahl, Ø60/100 – 200/300 mm, geeignet für Abgassysteme im Innenbereich, Verbindung mit Muffen und EPDM-Dichtungen.

**LIB**

bestehend aus starren konzentrischen Rohren und Formstücken aus PPH/Hochglanzedelstahl, Ø60/100 – 200/300 mm, geeignet für Abgassysteme im Innenbereich, Verbindung mit Muffen und EPDM-Dichtungen.

**LAB**

bestehend aus starren konzentrischen Rohren und Formstücken aus PPH/Hochglanzedelstahl, Ø60/100 – 200/300 mm, geeignet für Abgassysteme im Aussenbereich, Verbindung mit konischen Muffen.

**LAL**

bestehend aus starren konzentrischen Rohren und Formstücken aus PPH/pulverbeschichtetem Edelstahl, Ø60/100 – 200/300 mm, geeignet für Abgassysteme im Aussenbereich, Verbindung mit konischen Muffen.

**LAC**

bestehend aus starren konzentrischen Rohren und Formstücken aus PPH/kupferbeschichtetem Edelstahl, Ø60/100 – 110/160 mm, geeignet für Abgassysteme im Aussenbereich, Verbindung mit konischen Muffen.

**LAM**

bestehend aus starren konzentrischen Rohren und Formstücken aus PPH/matttem Edelstahl, Ø60/100 - 200/300 mm, geeignet für Abgassysteme im Aussenbereich, Verbindung mit konischen Muffen.

**LAS**

bestehend aus starren Rohren und Formstücken aus PPH, Ø80 – 315 mm (Var.1), starren konzentrischen Rohren und Formstücken aus PPH/Hochglanzedelstahl, - pulverbeschichtetem Edelstahl, Ø80/125 – 200/300 mm, mit Abzweiger 87° Ø60/100 – 80/125 mm (Var.2), starren konzentrischen Rohren und Formstücken aus PPH/Hochglanzedelstahl, mit Abzweiger 87° Ø60/100 – 80/125 mm (Var.3), und Zubehör, zum Anschluss mehrerer Verbraucher an einen gemeinsamen Schornstein im Innenbereich (Var. 2) und auch im Aussenbereich (Var. 3), Verbindung mit Muffen und EPDM-Dichtungen.

**CAS**

bestehend aus starren Rohren und Formstücken aus PPH, Ø80 – 315 mm, mit Abzweigern 45° und 87° Ø60 – 250 mm (Var.1), starren konzentrischen Rohren und Formstücken aus PPH/pulverbeschichtetem Edelstahl, Ø110/160 – 200/300 mm mit Abzweiger 87° Ø60/100 und 80/125 mm (Var.2), und Zubehör geeignet für Kaskaden in Innenräumen, Verbindung mit Muffen und EPDM-Dichtungen.

**ZUB**

Zubehör für Abgassysteme (Neutraboxen, Rohrschellen, Revisionstüren (Klappen), Kondensatpumpen usw.)

# KUNSTSTOFF-ABGASSYSTEME ALMEVA

## KENNZEICHNUNGEN DER SYSTEMELEMENTE

ALMEVA

Alle Bestandteile des Abgassystems Almeva werden gemäss der Norm EN 1443 klassifiziert. Diese Norm setzt die allgemeinen Anforderungen und die grundlegenden Funktionsbedingungen für Abgassysteme fest. Die Kennzeichnung erfolgt nach der Norm EN 14471, welche die Eigenschaften von Abgassystemen aus Kunststoff festlegt. Die Rohre werden in der Regel mit einem Aufdruck als Zeile mit allen vorgeschriebenen Daten gekennzeichnet. Formstücke sind mit einer sog. „Identifikationskennmarke“ gekennzeichnet (Zusammenfassung vorgeschriebener Daten eingestanzt auf der Muffe). Das gesamte System und alle Elemente des Systems sind zertifiziert und verfügen über das CE-Zeichen. Dieses entspricht der Richtlinie 93/68/EC und wird zusammen mit der Zertifikatsnummer 0036 CPD 9165 001 auf Aufklebern auf den einzelnen Komponenten angebracht.

Jede Abgasleitung muss mit einem entsprechenden Schild gekennzeichnet werden. Dieses Schild charakterisiert das entsprechende Abgassystem gemäss den Normen. Das Schild muss unverwischbar und deutlich lesbar sein, aus haltbarem Material bestehen und an einer sichtbaren Stelle angebracht werden. Auf dem Schild befinden sich der Firmenname oder die Handelsmarke des Herstellers, die Kennzeichnung gemäss der Norm EN 14471, der Nennquerschnitt und der Wärmewiderstand des Abgassystems, Angaben über den Hersteller und Kesseltyp, die Gesamtleistung der Anlage, Informationen über die Montagefirma (Anschrift, Telefon usw.), das Installationsdatum und die Nummer des Revisionsberichts.

### Kennzeichnungsbeispiel eines Rohres:

Almeva PP NW 80x2.2 Z-7.2-3128 TÜV/VKF Nr. Z 14700 /T120 PI W 2 O-20 R00 E100/Charge 07 053

### Kennzeichnungsbeispiel eines Formstückes:

Almeva PP  
T120;P1;W;2;O-20  
R00;E1 00 (bb)  
Z-7.2-3128 TÜV  
VKF Nr. Z 14700

### Kaminaufkleber EU:

		<b>Almeva AG</b> Industriestrasse 6 CH-9220 Bischofszell Switzerland Tel.: +41 71 644 90 20 Fax: +41 71 644 90 29 www.almeva.ch E-mail: info@almeva.ch	
Einwandiges Abgassystem <b>EN 14471</b> O T120 - P1 - O - W - 2 - O20 - LI - E - U  <b>EN 1443</b> T120 H1/P1 W 2 O20 E100		Zweiwandiges Abgassystem <b>EN 14471</b> O T120 - P1 - O - W - 2 - O00 - LI - E - U1 O T120 - P1 - O - W - 2 - O00 - LI - E - U0 O T120 - P1 - O - W - 2 - O00 - LE - E - U0  <b>EN 1443</b> T120 H1/P1 W 2 O00 E100	
Wärmewiderstand des Abgassystems 0,00 m <sup>2</sup> .K.W <sup>-1</sup>			
Nennweite mm		Nennweite mm	
Hersteller und Kesseltyp:			
Gesamtleistung der Anlage:			
Montagefirma (Anschrift, Telefon):			
Installationsdatum:			
Nummer des Revisionsberichts:			
<b>HINWEIS:</b> Der Kaminaufkleber muss sichtbar an den Abgasleitungen Almeva angebracht werden, immer sichtbar sein, darf nicht überstrichen, entfernt oder anderweitig beschädigt werden!			

## MATERIAL

### Starre Rohre, flexible Rohre und Formteile

Der Rohstoff für die Herstellung ist Polypropylen Homopolymer (PPH). Es handelt sich um eine thermoplastische hochmolekulare Masse, teilweise kristallisch mit einer wesentlich geringeren Dichte als andere eingesetzte Kunststoffe von  $0,90 - 0,91 \text{ g/cm}^3$ . Die Oberfläche ist nicht löslich und quillt auch nicht auf. PPH kann sehr gut geschweisst werden. PPH ist sehr alterungsbeständig und deshalb zeichnen sich die Systemelemente durch eine sehr lange Lebensdauer aus.

PPH hat eine ausgezeichnete chemische Beständigkeit gegen Säuren (ausgenommen Oxidationssäuren), Alkali und leichte Lösungsmittel. Es weist eine gute Widerstandsfähigkeit gegen Wettereinflüsse und Mikroorganismen auf, ist physiologisch unbedenklich. PPH weist im Vergleich zu anderen konventionellen Kunststoffen eine sehr gute Oberflächenhärte und ausreichende Flexibilität auch bei niedrigen Temperaturen auf. PPH zeichnet sich auch durch gute Schlagzähigkeit, gute Elektroisolationseigenschaften mit einer Kondensatsaugfähigkeit von fast null und hohe Temperaturbelastbarkeit (kurzzeitig auch  $140^\circ\text{C}$ ) aus. Es weist eine sehr geringe Wärmeleitfähigkeit (nur  $0,22\text{W/mK}$ ) auf, wodurch beim Betrieb die Rauchgastemperatur in den Leitungen nicht so stark sinkt wie beispielsweise bei Edelstahl. PPH gehört zur Gruppe der Thermoplaste, weshalb es nach Erwärmung und erneuter Abkühlung seine ausgezeichneten Eigenschaften behält. PPH-Rohre in schwarz sind gemäss EN ISO 8256:2004 UV-geschützt.

### Dichtungen

Lippendichtungsringe, Dichtungsringe und andere Dichtungselemente des Systems werden aus Ethylen Propylen Dien Kautschuk hergestellt (EPDM) und werden bereits beim Hersteller (werksseitig) in alle Rohre und Formstücke eingesetzt. Es handelt sich um ein sehr hochwertiges Elastomer mit langfristiger Widerstandsfähigkeit gegen Kondensateinwirkungen und hohe Temperaturen (kurzfristig bis zu  $150^\circ\text{C}$ ). Es ist alterungsbeständig, beständig gegen Oxidation, Ozon und atmosphärische Einflüsse. Dieser säurebeständige Gummi widersteht auch sehr gut Chemikalien wie etwa anorganischen Stoffen (einschliesslich Kohlendioxid) und organischen polaren Verbindungen. Allerdings weist EPDM eine schlechte Widerstandsfähigkeit gegen unverbrannte Erdölstoffe auf. Direkter Kontakt zu auf Erdöl basierenden Fetten und Ölen sollte also vermieden werden.

### Aussenmantel und Verbindungselemente

Bei den Systemen LIB, LAB und LAM werden der Aussenmantel und die Verbindungselemente aus Edelstahllegierung Material Nr. 1.4301 hergestellt (Bezeichnung gemäss Norm EN ISO X5CrNi 18-10) Chromnickel-Edelstahl lässt sich sehr gut schweissen, weist eine gute Dehnfähigkeit auf, lässt sich gut polieren, ist abriebbeständig, lässt sich gut recyceln und widersteht langfristig Temperaturen von bis zu  $300^\circ\text{C}$ . Der Stahl ist widerstandsfähig gegen Wasser, Wasserdampf, Luftfeuchtigkeit, leichten organischen und anorganischen Säuren.

Beim System LAC handelt es sich um das gleiche Ausgangsmaterial wie bei LIB und LAB, jedoch ist eine ausreichende Kupferschicht aufgalvanisiert, welches die gleiche Optik wie reines Kupfer garantiert.

Bei den Systemen LIL und LAL werden der Aussenmantel und die Verbindungselemente aus Edelstahl Nr. 1.4509 (Bezeichnung gemäss Norm EN ISO X3CrTi17) hergestellt. Dieser Edelstahl eignet sich zum Formen im Kaltzustand und die Oberfläche kann lackiert, metallisiert oder emailliert werden. Dank dieser Eigenschaften kann die Oberfläche aller Komponenten der Systeme LIL und LAL sehr leicht pulverbeschichtet werden. Durch die Korrosionsbeständigkeit des Materials dient die Pulverbeschichtung rein ästhetischen Zwecken.

# SISTEMAS SINTÉTICOS DE EVACUACIÓN DE GASES ALMEVA

## CARACTERÍSTICAS PRINCIPALES DEL SISTEMA

ALMEVA

### Ventajas

El sistema de evacuación de gases de combustión Almeva es un producto moderno y bien diseñado. Años de desarrollo continuo han dado como resultado una gama de tubos, piezas moldeadas y accesorios de alta calidad y precisión. La forma precisa de los racores permite unas excelentes propiedades neumáticas de las tuberías, lo que garantiza un flujo perfecto de los gases de combustión.

Las juntas elastoméricas garantizan una hermeticidad instantánea de los acoplamientos, una alta resistencia, pero también una flexibilidad duradera de las conexiones. La instalación de los sistemas es fácil y rápida.

La alta fiabilidad, la rapidez de montaje y la facilidad de revisión permiten una alta productividad a las empresas que construyen e instalan nuevas chimeneas o renuevan las existentes.

### Utilización según la fuente de calor

- el sistema está diseñado para expulsar los gases de combustión de calderas de condensación y de baja temperatura cuyos gases no superan los 120°C
- está destinado principalmente a utilizarse en modo de sobrepresión (la presión en el interior del sistema de gases de combustión es mayor que en el exterior). También puede utilizarse en un sistema de tiro natural
- el sistema no es resistente al fuego de hollín
- es adecuado para sistemas de evacuación de gases utilizados para el funcionamiento en húmedo
- este sistema solo puede aplicarse en sistemas de calefacción que usen combustible gaseoso, por ejemplo gas natural y combustible líquido (LTO con contenido de azufre  $\leq 0,2\%$  o queroseno)

### Utilización según el lugar de instalación

- para nueva instalación de sistemas de evacuación de gases
- para el saneamiento de instalaciones de evacuación de gases ya existentes
- por sus cualidades, existen sistemas apropiados para su instalación en interiores y otros para exteriores

### Componentes del sistema

El sistema de Almeva incluye muchos componentes que forman parte de las soluciones más modernas para un sistema de evacuación. Consta de más de 200 artículos, cada uno de los cuales está disponible en varios tamaños/diámetros, lo que hace un total de más de 2.250 artículos catalogados que forman un complejo sistema de evacuación.

Esto nos permite afirmar que Almeva es capaz de ofrecer la más amplia gama de sistemas sintéticos para la evacuación de gases de combustión garantizando la calidad del producto.

# SISTEMAS SINTÉTICOS DE EVACUACIÓN DE GASES ALMEVA

## RESUMEN DE LOS SISTEMAS Y SUS COMPONENTES

### El sistema de evacuación de gases Almeva ofrece las siguientes soluciones

ALMEVA

#### STARR

Compuesto por tubos rígidos y piezas moldeadas de PPH, Ø60 – 315 mm y accesorios, para instalación en interiores y montaje en ascensión rectilínea, empalmes con manguitos y juntas de EPDM.

#### FLEX

Compuesto por tubos flexibles y piezas moldeadas de PPH, Ø60 – 200mm y accesorios, especialmente recomendado para el montaje de tubos de ascensión recta y escalonada, empalmes con tuercas de unión y juntas de EPDM.

#### LIK

Compuesto por tubos rígidos concéntricos y piezas moldeadas de PPH/PPH, Ø60/100 – 80/125mm, para instalación en interiores, empalmes con manguitos y juntas de EPDM.

#### LIL

Compuesto por tubos rígidos concéntricos y piezas moldeadas de PPH/acero inoxidable en epoxi blanco, Ø60/100 – 200/300mm, para instalación en interiores, empalmes con manguitos y juntas de EPDM.

#### LIB

Compuesto por tubos rígidos concéntricos y piezas moldeadas de PPH/acero inoxidable pulido, Ø60/100 – 200/300mm, para instalación en interiores, empalmes con manguitos y juntas de EPDM.

#### LAB

Compuesto por tubos rígidos concéntricos y piezas moldeadas de PPH/acero inoxidable pulido, Ø60/100 – 200/300mm, para instalación en exteriores, empalmes con manguitos cónicos.

#### LAL

Compuesto por tubos rígidos concéntricos y piezas moldeadas en PPH/acero inoxidable en epoxi blanco, Ø60/100 – 200/300mm, para instalación en exteriores, empalmes con manguitos cónicos.

#### LAC

Compuesto por tubos rígidos concéntricos y piezas moldeadas de PPH/acero inoxidable cobreado, Ø60/100 – 110/160mm, para instalación en exteriores, empalmes con manguitos cónicos.

#### LAM

Compuesto por tubos rígidos concéntricos y piezas moldeadas de PPH/acero inoxidable mate, Ø60/100 - 200/300mm, para instalación en exteriores, empalmes con manguitos cónicos.

#### LAS

Compuesto por tubos rígidos de PPH Ø80 - 315 mm, con codo 87° Ø60 – 250 mm (Var. 1), tubos rígidos concéntricos de PPH/acero inoxidable pulido - acero inoxidable en epoxi blanco Ø80/125 – 200/300 mm, con codo 87° Ø60/100 – 80/125 mm (Var. 2), tubos rígidos concéntricos de PPH/acero inoxidable pulido Ø110/160 – 200/300mm, con codo 87° Ø60/100 – 80 125 mm (Var. 3) y accesorios, diseñados para conectar varias calderas a una chimenea común en interiores (Var. 2) y también en exteriores (Var. 3). Los empalmes se realizan con manguitos y juntas de EPDM.

#### CAS

Compuesto por tubos rígidos de PPH Ø80 – 315 mm, con codo 45°, 87° Ø60 – 250 mm (Var.1), PPH/acero inoxidable en epoxi blanco Ø110/160 – 200/300mm, con codos 87° Ø60/100 y 80/125 mm (Var.2) y accesorios, apropiado para instalación en cascada en interiores, empalmes con manguitos y juntas de EPDM.

#### ZUB

Accesorios para los sistemas de evacuación de gases (kits de mantenimiento, abrazaderas, portones, tapas, bombas de condensación, etc.).

# SISTEMAS SINTÉTICOS DE EVACUACIÓN DE GASES ALMEVA

## MARCADO DE LOS ELEMENTOS DEL SISTEMA

ALMEVA

Todos los componentes del sistema de evacuación Almeva están clasificados según la norma EN 1443. Esta norma especifica los requisitos generales y las condiciones esenciales de funcionamiento de los sistemas de gases de combustión fabricados en polipropileno. El marcado se realiza de acuerdo con la norma EN 14471, que determina las características de los sistemas de evacuación de gases fabricados en polipropileno. Las tuberías suelen estar marcadas con un impreso en línea con todos los datos requeridos.

Los componentes están marcados con la llamada "marca de identificación". (resumen de los datos requeridos estampados en el manguito).

El sistema en su totalidad y todos sus componentes están certificados y llevan la marca CE. Esto cumple con la Directiva 93/68/CE y está marcado con el número de certificación 0036 CPD 9165 001 en las etiquetas de los distintos componentes. Cada chimenea debe estar marcada con una etiqueta que identifica los distintos flujos de humos de acuerdo con la normativa vigente.

Esta etiqueta debe ser indeleble y claramente legible, de material duradero y colocada en un lugar bien visible. En ella debe figurar el nombre o la marca del fabricante, el marcado según la norma EN 14471, el diámetro nominal y la resistencia térmica del sistema de evacuación de gases de combustión, información sobre el fabricante y el tipo de caldera, la potencia total del sistema, información sobre la empresa instaladora (dirección, teléfono, etc.), la fecha de instalación y el número del informe de inspección.

### Ejemplo de marcado de tubos:

Almeva PP NW 80x2.2 Z-7.2-3I28 TÜV/VKF Nr. Z 14700 /TI20 PI W 2 O-20 R00 E100/Charge 07 053

### Ejemplo de marcado de piezas moldeadas:

Almeva PP  
T120;P1;W;2;O-20  
R00; E1 00 (bb)  
Z-7.2-3I28 TÜV  
VKF Nr. Z 14700

### Etiqueta de chimenea EU:

 <p><b>Almeva AG</b> Industriestrasse 6 CH-9220 Bischofszell Switzerland Tel.: +41 71 644 90 20 Fax: +41 71 644 90 29 www.almeva.ch E-mail: info@almeva.ch</p>	
Sistema de evacuación de simple pared <b>EN 14471</b> O T120 - P1 - O - W - 2 - O20 - LI - E - U	Sistema de evacuación de doble pared <b>EN 14471</b> O T120 - P1 - O - W - 2 - O00 - LI - E - U1 O T120 - P1 - O - W - 2 - O00 - LI - E - U0 O T120 - P1 - O - W - 2 - O00 - LE - E - U0
<b>EN 1443</b> T120 H1/P1 W 2 O20 E100	<b>EN 1443</b> T120 H1/P1 W 2 O00 E100
Resistencia térmica del sistema 0,00 m <sup>2</sup> .K.W <sup>-1</sup>	
Diámetro nominal mm	Diámetro nominal mm
Fabricante y tipo de caldera:	
Potencia total del sistema:	
Empresa instaladora (dirección, teléfono, etc.):	
Fecha de la instalación:	
Número del informe de inspección:	
<b>NOTA:</b> La etiqueta de la chimenea debe estar visiblemente adherida a los conductos de gases de combustión de Almeva, siempre visible, no puede ser pintada, retirada o dañada de otra forma.	

# SISTEMAS SINTÉTICOS DE EVACUACIÓN DE GASES ALMEVA

## MATERIAL

### Tuberías rígidas de plástico, mangueras flexibles y bloques

La materia prima de fabricación es el polipropileno homopolímero (PPH). Se trata de una masa macrocelular termoplástica, parcialmente cristalina de una densidad muy superior a otros plásticos empleados de 0,90-0,91 g/cm<sup>3</sup>. La superficie es insoluble y no se hincha con el agua. El PPH es difícil de encolar, en cambio es fácil de soldar.

El PPH tiene una buena durabilidad contra el envejecimiento y por lo tanto los elementos del sistema se caracterizan de una larga vida útil. Tiene una excelente resistencia química a los ácidos (excepto a los ácidos oxidantes), álcalis y disolventes suaves. Tiene una alta resistencia a los efectos climáticos, a los microorganismos y es inocuo. Los tubos PPH de color negro están protegidos contra los rayos UV según la norma EN ISO 8256:2004.

En comparación con otros plásticos convencionales tiene una superficie muy dura y suficientemente flexible, incluso a temperaturas bajas. El PPH también se caracteriza por su buena resistencia al impacto, sus buenas propiedades de electroaislamiento con una absorción prácticamente nula de condensado y una buena resistencia a temperaturas (a corto plazo hasta 150°C). También tiene una conductividad térmica muy baja (solo 0,22 W/mK), por lo que no provoca una gran disminución de la temperatura de los gases de combustión en las tuberías, como ocurre, por ejemplo, con el acero inoxidable. El PPH se encuentra entre los termoplásticos y, por lo tanto, cuando se calienta y se enfría, conserva sus excelentes propiedades.

### Juntas de hermeticidad

Las juntas de hermeticidad y otros elementos de unión del sistema se fabrican de caucho de etileno-propileno-dieno -clase M (EPDM) y se insertan en todos los tubos y piezas moldeadas en fábrica. Se trata de un elastómero de gran calidad con una resistencia a largo plazo a condensaciones y altas temperaturas (puede llegar a soportar brevemente hasta los 150°C). Es resistente al envejecimiento, a la oxidación, al ozono y a los fenómenos meteorológicos. Esta goma resistente a ácidos también resiste muy bien los productos químicos como los materiales inorgánicos (incluido el dióxido de carbono) y los compuestos orgánicos polares. Sin embargo muestra poca resistencia a petróleos crudos, por lo que se deben evitar contactos con grasas con bases de petróleo y aceites.

### Revestimiento exterior y elementos de conexión

Los sistemas LIB, LAB y LAM tienen las capas exteriores y los elementos de conexión fabricados de acero inoxidable de aleación de construcción, material no. 1.4301 (marcado según EN ISO X5CrNi18-10). El acero cromo-níquel es fácil de soldar, y presenta una buena capacidad de dilatación y es fácil de pulir y reciclar, es resistente al desgaste y resiste temperaturas a largo plazo de hasta 300°C. El acero es resistente al agua, al vapor, a la humedad ambiental y a ácidos ligeros orgánicos e inorgánicos.

El sistema LAC proporciona el mismo material de partida que LIB y LAB. Está revestido de cobre galvanizado, y proporciona la misma apariencia óptica y pureza que el cobre genuino.

Los sistemas LIL y LAL tienen las capas exteriores y los elementos de conexión fabricados de acero de construcción al carbono no. 1.4509 (marcado según la norma EN ISO X3CrTi17.) Este acero es apto para moldes en frío y la superficie se puede pintar, metalizar o esmaltar. Gracias a estas cualidades, las superficies de todos los componentes del sistema LIL y LAL están recubiertas de pintura en polvo blanca. Debido a la resistencia a la corrosión del material, el recubrimiento en polvo sirve para fines puramente estéticos.

# PLASTİK GAZ BACA SİSTEMLERİ ALMEVA

## SİSTEMİN ANA ÖZELLİKLERİ

ALMEVA

### Avantajları

Almeva gaz baca sistemi modern ve gelişmiş bir baca sistemidir. Yıllar süren sürekli gelişim, yüksek kaliteli, hassas borular, kalıplanmış parçalar ve aksesuarlardan oluşan bir ürün yelpazesi ile sonuçlanmıştır. Soket bağlantılarının hassas şekli, baca gazlarının mükemmel akışını garanti eden boruların mükemmel pnömatik özelliklerini sağlar. Elastomerik contalar kaplinlerin sıkı olmasını sağlar. Bu contalar mükemmel ve anında bir sızdırmazlık kuvveti, yüksek bir direnç gücü ve aynı zamanda bağlantıların dayanıklı bir esnekliğini garanti eder: kurulum kolay ve hızlıdır. Sonuç olarak, baca ve ısıtma tesisatı şirketleri yeni bacalar inşa etmek ve kurmak veya mevcut üniteleri yenilemek için son derece verimli bir şekilde çalışabilmektedir.

### Isı kaynağına göre kullanım

- sistem, kazanda maksimum baca gazı sıcaklığı 120°C olan yoğuşmalı ve düşük sıcaklıklı kazanlardan baca gazı tahliyesi için tasarlanmıştır
- sistem öncelikle aşırı basınç modunda kullanılmak üzere tasarlanmıştır (baca gazı sisteminin içindeki basınç dışarıdakinden daha yüksektir)
- sistem kurum yangınına dayanıklı değildir
- sistem ıslak çalışma için kullanılan bacalar için tasarlanmıştır
- sistem sadece gaz yakıtların veya doğal gazın (L, H) ve sıvı yakıtların (kükürt içeriği  $\leq 0,2$  olan LTO, parafin) yakıldığı ısıtma sistemleri için kullanılabilir

### Kurulum yerine göre kullanım

- baca gazı sistemlerinin yeni kurulumu (montajı) için
- mevcut sistemlerin yenilenmesi için
- uygun sistemler kapalı ve açık alanlara kurulabilir

### Sistem bileşenleri

Almeva baca sistemi, işlevsel modern baca sistemlerinin bir parçası olarak yeri doldurulamaz birçok bileşene sahiptir. Her biri farklı boyutlarda 200'den fazla eleman vardır ve bu da karmaşık bir baca sistemi oluşturan toplam 2250'den fazla kataloglanmış öge anlamına gelir.

Almeva, plastik bacalar alanında en geniş ürün yelpazesini garantili kalite ile sunmaktadır.

# PLASTİK GAZ BACA SİSTEMLERİ ALMEVA

## İSTEMLERE VE ELEMANLARINA GENEL BAKIŞ

### Almeva serisi çeşitli gaz baca sistemleri sunmaktadır

#### STARR

PPH, Ø60 - 315 mm sert borulardan ve kalıplanmış parçalardan ve aksesuarlardan oluşur, iç mekanda kurulum için ve doğrusal yükselişte monte edilir, soketler ve EPDM contalarla bağlantılar.

#### FLEX

PPH, Ø60 - 200mm esnek borular ve kalıplanmış parçalardan ve aksesuarlardan oluşur, özellikle düz ve kademeli yükselme borularının montajı, rakor somunları ve EPDM contaları ile bağlantılar için önerilir.

#### LIK

PPH/PPH, Ø60/100 - 80/125mm eş merkezli sert borular ve kalıplanmış parçalardan oluşur, iç mekan montajı için, soketli bağlantılar ve EPDM contalar.

#### LIL

Eş merkezli sert borular ve PPH/paslanmaz çelikten kalıplanmış parçalardan oluşur, beyaz epoksi, Ø60/100 - 200/300mm, iç mekan montajı için, soketli bağlantılar ve EPDM contalar.

#### LIB

PPH/paslanmaz çelik cilalı, Ø60/100 - 200/300mm eş merkezli sert borular ve kalıplanmış parçalardan oluşur, iç mekan montajı için, soketli ve EPDM contalı bağlantılar.

#### LAB

PPH/paslanmaz çelik cilalı, Ø60/100 - 200/300mm eş merkezli sert borular ve kalıplanmış parçalardan oluşur, dış mekan montajı için, konik konektörlerle bağlantılar.

#### LAL

Eş merkezli sert borulardan ve PPH/paslanmaz çelikten kalıplanmış parçalardan oluşur, beyaz epoksi, Ø60/100 - 200/300mm, dış mekan montajı için, konik konektörlerle bağlantılar.

#### LAC

PPH/paslanmaz çelik bakır kaplamalı, Ø60/100 - 110/160mm eş merkezli sert borular ve kalıplanmış parçalardan oluşur, dış mekan kurulumu için, konik konektörlerle bağlantılar.

#### LAM

PPH/paslanmaz çelik mat, Ø60/100 - 200/300mm eş merkezli sert borular ve kalıplanmış parçalardan oluşur, dış mekan montajı için, konik konektörlerle bağlantılar.

#### LAS

PPH sert borulardan oluşur, Ø80 - 315 mm, 87° Ø60 - 250 mm branşmanlı (Var. 1), PPH/ paslanmaz çelik cilalı konsantrik sert borular - beyaz epoksi paslanmaz çelik Ø80/125 - 200/300 mm, 87° Ø60/100 - 80/125 mm branşmanlı (Var. 2), PPH/paslanmaz çelik cilalı eş merkezli sert borular Ø110/160 - 200/300 mm, 87° Ø60/100 - 80 125 mm branşmanlı (Var. 3) ve aksesuarlar, iç meknlarda (Var. 2) ve ayrıca dış meknlarda (Var. 3) birkaç kazanı ortak bir bacaya bağlamak için tasarlanmıştır. Soketli ve EPDM contalı bağlantılar.

#### CAS

PPH, Ø80 - 315 mm, 45°, 87° Ø60 - 250 mm (Var.1), PPH/paslanmaz çelik beyaz toz boyalı Ø110/160 - 200/300 mm, 87° Ø60/100 ve 80/125 mm (Var.2) branşmanlı sert borular ve kalıplanmış parçalardan ve aksesuarlardan oluşur, iç meknlarda kademeli kurulum için uygundur, soketli ve EPDM contalı bağlantılar.

#### ZUB

Baca sistemleri için aksesuarlar (nötr kutular, klipsler, temizleme kapısı, yoğuşma pompaları, vb.)

# PLASTİK GAZ BACA SİSTEMLERİ ALMEVA

## SİSTEM ELEMANLARININ İŞARETLENMESİ

ALMEVA

Almeva sisteminin tüm baca parçaları, baca sistemleri için genel gereklilikleri ve temel çalışma koşullarını düzenleyen EN 1443'e göre sınıflandırılır ve plastik gaz baca sistemlerinin özelliklerini belirleyen EN 14471'e göre işaretlenir. Borular normalde gerekli tüm veriler doğrultusunda baskı yapılarak işaretlenir. Her bir bileşen „tanımlama işareti“ (soket üzerine basılmış gerekli verilerin özeti) içerir.

Tüm sistem ve tüm sistem bileşenleri sertifikalıdır ve CE işareti taşır. Bu, 93/68/EC Direktifine uygundur ve münferit bileşenlerin üzerindeki etiketlerde 0036 CPD 9165 001 sertifika numarası ile işaretlenmiştir.

Her baca ilgili bir etiketle işaretlenmelidir. Bu etiket, gaz baca sistemini standartlara göre tanımlar.

Etiket silinmez ve açıkça okunabilir olmalı, dayanıklı malzemeden yapılmış ve görünür bir yere yapıştırılmış olmalıdır. Üreticinin şirket adını veya ticari markasını, EN 14471'e göre sınıflandırmayı, gaz baca sisteminin nominal çapını ve ısı direncini, üretici ve kazan tipi hakkında bilgileri, sistemin toplam çıkışını, kurulum şirketi hakkında bilgileri (adres, telefon numarası vb.), kurulum tarihini ve denetim raporunun numarasını içerir.

### Boru işaretleme örneği:

Almeva PP NW 80x2.2 Z-7.2-3I28 TÜV/VKF Nr. Z 14700 /TI20 PI W 2 O-20 R00 E100/Charge 07 053

### Kalıplanmış parça işaretleme örneği:

Almeva PP  
T120;P1;W;2;O-20  
R00; E1 00 (bb)  
Z-7.2-3I28 TÜV  
VKF Nr. Z 14700

### AB Baca etiketi:

 <p><b>Almeva AG</b> Industriestrasse 6 CH-9220 Bischofszell Switzerland Tel.: +41 71 644 90 20 Fax: +41 71 644 90 29 www.almeva.ch E-mail: info@almeva.ch</p>	
<p>Tek katmanlı sistem baca</p> <p><b>EN 14471</b> O T120 - P1 - O - W - 2 - O20 - LI - E - U</p> <p><b>EN 1443</b> T120 H1/P1 W 2 O20 E100</p>	<p>İki katmanlı sistem baca</p> <p><b>EN 14471</b> O T120 - P1 - O - W - 2 - O00 - LI - E - U1 O T120 - P1 - O - W - 2 - O00 - LI - E - U0 O T120 - P1 - O - W - 2 - O00 - LE - E - U0</p> <p><b>EN 1443</b> T120 H1/P1 W 2 O00 E100</p>
<p>Baca ısı direnci 0,00 m<sup>2</sup>.K.W<sup>-1</sup></p>	
<p>Nominal çap mm</p>	<p>Nominal çap mm</p>
<p>Cihazların üreticisi ve tipi:</p>	
<p>Cihazların tam nominal gücü:</p>	
<p>Montajcı detayları, adres, tel:</p>	
<p>Kurulum tarihi:</p>	
<p>Montajcının lisans numarası:</p>	
<p><b>NOT:</b> Baca etiketi Almeva yanma gazı yollarına görünür şekilde monte edilmeli, her zaman görünür olmalı, üzeri boyanmamalı, çıkarılmamalı veya başka şekilde hasar görmemelidir!</p>	

# PLASTİK GAZ BACA SİSTEMLERİ ALMEVA

## MATERYAL

### Plastik sert borular, esnek borular ve kalıplanmış parçalar

Üretimin hammaddesi polipropilen homopolimerdir (PPH). Kısmen kristal, yüksek moleküler ağırlıklı termoplastik bir malzemedir ve yoğunluğu endüstride kullanılan diğer plastiklerden önemli ölçüde daha düşük olup 0,90 ila 0,91 g.cm<sup>-3</sup> arasında değişmektedir. PPH çok kolay kaynaklanabilir. Yüzey çözünmez ve şişmez. Yaşlanmaya karşı çok dayanıklıdır, böylece sistem elemanları çok uzun bir hizmet ömrü ile karakterize edilir.

PPH asitlere (oksitleyici asitler hariç), alkalilere ve hafif çözücülere karşı mükemmel dirence sahiptir. Hava koşullarına ve mikroplara karşı yüksek bir dirence sahiptir. Fizyolojik olarak nötrdür. Diğer geleneksel plastiklerle karşılaştırıldığında, PPH çok iyi bir yüzey sertliğine ve düşük sıcaklıklarda bile yeterli esnekliğe sahiptir.

PPH ayrıca iyi darbe direnci, neredeyse sıfır yoğunlaşma emme kapasitesi ile iyi elektrik yalıtım özellikleri ve yüksek sıcaklık direnci (kısa bir süre için 140°C'de bile) ile karakterize edilir. Çok düşük bir termal iletkenliğe (sadece 0,22W/mK) sahiptir, bu da çalışma sırasında borulardaki baca gazlarının sıcaklığının örneğin paslanmaz çelikte olduğu kadar düşmediği anlamına gelir. PPH termoplastikler grubuna aittir ve bu nedenle ısıtma ve yeniden soğutma sonrasında üstün özelliklerini korur. Siyah PPH UV korumalıdır EN ISO 8256:2004.

### Sızdırmazlık contaları

Sızdırmazlık contaları ve diğer sistem bağlantıları etilen propilen dien kauçuktan (EPDM) yapılı ve tüm borulara ve fabrikada kalıplanmış parçalara yerleştirilir. Yoğuşmaya ve yüksek sıcaklıklara (kısaca 150°C'ye kadar dayanabilir) karşı uzun süreli direnç gösteren yüksek kaliteli bir elastomerdir. Yaşlanmaya, oksidasyona, ozona ve hava koşullarına karşı dayanıklıdır. Aside dayanıklı bu kauçuk ayrıca inorganik malzemeler (karbondioksit dahil) ve polar organik bileşikler gibi kimyasallara da çok iyi direnç gösterir. Bununla birlikte, EPDM ham yağlara karşı çok az direnç gösterir, bu nedenle petrol katı ve sıvı yağları ile doğrudan temastan kaçınılmalıdır.

### Dış kaplama ve ankraj elemanları

LIB, LAB ve LAM sistemlerinin dış kaplaması ve bunların ankraj elemanları paslanmaz çelik alaşım no. 1.4301 (EN ISO X5CrNi 18-10'a göre işaretlenmiştir). Bu krom-nikel paslanmaz çeliğin kaynaklanması ve cilalanması kolaydır ve yüksek elastikiyete sahiptir. Aşınmaya dayanıklıdır, kolayca geri dönüştürülebilir ve 300°C'ye kadar uzun süreli sıcaklık direncine sahiptir. Çelik suya, buhara, havadaki neme ve zayıf organik ve inorganik asitlere karşı dayanıklıdır.

LAC sistemi, LIB ve LAB sistemleriyle aynı malzemelerden yapılmıştır. Ayrıca saf bakır ile aynı estetik yüzeyi garanti eden galvanik bakır ile kaplanmıştır.

LIL, LAL sistemlerinin ve bunların ankraj elemanlarının dış kaplaması 1.4509 numaralı paslanmaz çelikten yapılmıştır (EN ISO X3CrTi17'ye göre işaretlenmiştir). Bu paslanmaz çelik soğuk şekillendirmeye uygundur ve yüzeyi boyanabilir, metalize edilebilir veya emaye kaplanabilir. Bu özelliklerinden dolayı, LIL ve LAL sistemlerinin tüm bileşenlerinin yüzeyleri beyaz epoksi toz boya ile kaplanmıştır. Malzemenin korozyon direnci nedeniyle, toz kaplama tamamen estetik amaçlıdır.

# ΣΥΣΤΗΜΑ ΚΑΠΝΟΔΟΧΟΥ ALMEVA

## ΧΑΡΑΚΤΗΡΙΣΤΙΚΑ ΒΑΣΙΚΟΥ ΣΥΣΤΗΜΑΤΟΣ

ALMEVA

### Πλεονεκτήματα

Πρόκειται για ένα σύγχρονο, προηγμένο σύστημα καπνοδόχων με μία δοκιμασμένη στο χρόνο διαδικασία που έχει πετύχει την απόλυτη ακρίβεια και ποιότητα σωληνώσεων, μπλοκ και όλων των υπολοίπων εξαρτημάτων. Η σχεδιασμένη με ακρίβεια υποδοχή σύνδεσης παρέχει εξαιρετικά υδραυλικά χαρακτηριστικά σωληνώσεων. Έτσι εξασφαλίζεται η άσφογη ροή καύσης και χαμηλές πιθανότητες φραγής.

Οι υποδοχές σύνδεσης σφραγίζονται με ελαστομερείς δακτύλιους που εξασφαλίζουν εξαιρετική δυναμική σφραγίσματος και μακροχρόνια ευλυγισία σύνδεσης και αντίθετα με άλλα συστήματα, επιτρέπουν την γρήγορη και εύκολη ολοκλήρωση του συστήματος.

Η απρόσκοπτη εργασία, η γρήγορη συναρμολόγηση και η εύκολη επιθεώρηση έχουν σαν αποτέλεσμα την υψηλή παραγωγικότητα κατά την εγκατάσταση νέας καπνοδόχου ή την ανακαίνιση υφιστάμενων. -

### Χρήση ανάλογα με τον τύπο της συσκευής και το είδος της διαδρομής των καυσαερίων

- Στραγγίζει τα καυσαέρια από λέβητες συμπύκνωσης και χαμηλών θερμοκρασιών, με μέγιστη θερμοκρασία καυσαερίων στην έξοδο της συσκευής, τους 120 °C.
- Έχει σχεδιαστεί κυρίως για πιεστικές και υπέρ πιεστικές διαδρομές καυσαερίων (η πίεση στην εσωτερική επιφάνεια της καπνοδόχου κατά την διάρκεια λειτουργίας είναι πολύ υψηλότερη από ότι στο εξωτερικό της). Μπορεί επίσης να χρησιμοποιηθεί και για καπνοδόχους με φυσικό ελκυσμό.
- Δεν έχει σχεδιαστεί για διαδρομές καυσαερίων που μπορεί να παραχθεί καύση σταχτών.
- Είναι κατάλληλη για καπνοδόχους οι οποίες είναι σχεδιασμένες να λειτουργούν σε υγρές συνθήκες λειτουργίας.
- Χρησιμοποιείται μόνο σε διαδρομές καυσαερίων από συσκευές που καίνε αέρια καύσιμα, για την ακρίβεια ορυκτό αέριο (L, H) και υγρά καύσιμα (LTO με περιεκτικότητα θείου  $\leq 0,2$  %, κηροζίνη).

### Χρήση ανάλογα με τον τύπο της εγκατάστασης

- Για νέα κατασκευή (εγκατάσταση) καπνοδόχων.
- Για ανακαίνιση υφιστάμενων καπνοδόχων και καπναγωγών.
- Δυνατότητα χρήσης σχετικού συστήματος σε εσωτερικούς και εξωτερικούς χώρους.

### Στοιχεία συστήματος

Το σύστημα καπνοδόχου Almeva περιέχει πολλά εξαρτήματα τα οποία αποτελούν αναντικατάστατα μέρη μίας σύγχρονης λειτουργικής διαδρομής καυσαερίων. Περιλαμβάνει πάνω από 200 εξαρτήματα όπου το κάθε ένα είναι διαθέσιμο σε διάφορες διαστάσεις και έτσι στο σύνολο υπάρχουν περισσότερα από 1550 προϊόντα καταλόγου που αποτελούν αυτό το ολοκληρωμένο σύστημα καπνοδόχου.

Ως αποτέλεσμα μιας πληθώρας άσφογα συντονισμένων εξαρτημάτων, η Almeva μπορεί να προσφέρει τη μεγαλύτερη ποικιλία εξαρτημάτων σε συστήματα καπνοδόχων συμπυκνωμάτων με εγγυημένη ποιότητα.

## ΠΕΡΙΛΗΨΗ ΤΩΝ ΥΠΟΣΥΣΤΗΜΑΤΩΝ ΚΑΙ ΤΩΝ ΣΤΟΙΧΕΙΩΝ ΤΟΥΣ

Το σύστημα καπνοδόχου Almeva αποτελείται από διάφορα υποσυστήματα καπνοδόχων

### STARR

Αποτελείται από άκαμπτους σωλήνες και εξαρτήματα PPH, διατομής Ø60 – 315 mm. Προορίζονται κυρίως για χώρους εσωτερικούς χώρους, χρησιμοποιούνται ως αγωγοί σε ευθύγραμμες καπνοδόχους και η σύνδεσή τους γίνεται με συνδέσμους υποδοχής με παρέμβυσμα EPDM.

### FLEX

Αποτελείται από εύκαμπτους σωλήνες και εξαρτήματα PPH, διατομής Ø60 – 200 mm. Προορίζονται κυρίως ως εσωτερικοί αγωγοί σε καπνοδόχους ανεξαρτήτου διαδρομής, η σύνδεσή τους γίνεται με παξιμάδια ή με συνδέσμους τύπου μαγιονέτ και η στεγανοποίηση τους με παρέμβυσμα EPDM.

### LİK

Αποτελείται από ομόκεντρους άκαμπτους σωλήνες και εξαρτήματα PPH/PPH, διατομής Ø60/100 – 80/125 mm. Προορίζονται για διαδρομές καυσαερίων σε εσωτερικούς χώρους και η σύνδεσή τους γίνεται με συνδέσμους υποδοχής με παρέμβυσμα EPDM.

### LİL

Αποτελείται από ομόκεντρους άκαμπτους σωλήνες και εξαρτήματα PPH/ανοξειδωτος χάλυβας με λευκή ηλεκτροστατική βαφή, διατομής Ø60/100 – 200/300 mm. Προορίζονται για διαδρομές καυσαερίων σε εσωτερικούς χώρους και η σύνδεση των εξωτερικών αγωγών γίνεται με συνδέσμους υποδοχής με παρέμβυσμα EPDM

### LIB

Αποτελείται από ομόκεντρους άκαμπτους σωλήνες και εξαρτήματα PPH/ανοξειδωτος χάλυβας, διατομής Ø60/100 – 200/300 mm. Προορίζονται για διαδρομές καυσαερίων σε εσωτερικούς χώρους και η σύνδεση των εξωτερικών αγωγών γίνεται με συνδέσμους υποδοχής με παρέμβυσμα EPDM.

### LAB

Αποτελείται από ομόκεντρους άκαμπτους σωλήνες και εξαρτήματα PPH/ανοξειδωτος χάλυβας, διατομής Ø60/100 – 200/300 mm. Προορίζονται για διαδρομές καυσαερίων σε εξωτερικούς χώρους και η σύνδεση των εξωτερικών αγωγών γίνεται με κωνικούς συνδέσμους.

### LAL

Αποτελείται από ομόκεντρους άκαμπτους σωλήνες και εξαρτήματα PPH/ανοξειδωτος χάλυβας με λευκή ηλεκτροστατική βαφή, διατομής Ø60/100 – 200/300 mm. Προορίζονται για διαδρομές καυσαερίων σε εξωτερικούς χώρους και η σύνδεση των εξωτερικών αγωγών γίνεται με κωνικούς συνδέσμους.

### LAC

Αποτελείται από ομόκεντρους άκαμπτους σωλήνες και εξαρτήματα PPH/ανοξειδωτος χάλυβας με επικάλυψη χαλκού, διατομής Ø60/100 – 110/160mm. Προορίζονται για διαδρομές καυσαερίων σε εξωτερικούς χώρους και η σύνδεση των εξωτερικών αγωγών γίνεται με κωνικούς συνδέσμους.

### LAM

Αποτελείται από ομόκεντρους άκαμπτους σωλήνες και εξαρτήματα PPH/ανοξειδωτος χάλυβας Ματτ, διατομής Ø60/100 – 200/300 mm. Προορίζονται για διαδρομές καυσαερίων σε εξωτερικούς χώρους και η σύνδεση των εξωτερικών αγωγών γίνεται με κωνικούς συνδέσμους.

### LAS

- **Παραλλαγή 1** - Άκαμπτοι σωλήνες και εξαρτήματα PPH, διατομής Ø80 – 315 mm με διακλαδώσεις 87° Ø60 – 250 mm,
- **Παραλλαγή 2** - Ομόκεντροι άκαμπτοι σωλήνες και εξαρτήματα PPH/ανοξειδωτος χάλυβα με λευκή ηλεκτροστατική βαφή διατομής Ø80/125 – 200/300 mm με διακλαδώσεις 87° διατομής Ø60/100 – 80/125 mm,
- **Παραλλαγή 3** - Ομόκεντροι άκαμπτοι σωλήνες και εξαρτήματα PPH/ανοξειδωτος χάλυβας, διατομής Ø80/125 – 200/300 mm με διακλαδώσεις 87° διατομής Ø60/100 – 80/125 mm,

Προορίζονται για την πολλαπλή σύνδεση συσκευών σε μία κοινή καμινάδα σε εσωτερικό ή εξωτερικό χώρο και η σύνδεση των εξωτερικών αγωγών γίνεται με συνδέσμους υποδοχής με παρέμβυσμα EPDM ή με κωνικούς συνδέσμους.

### CAS

- **Παραλλαγή 1** - Άκαμπτοι σωλήνες και εξαρτήματα PPH, διατομής DN 80 – 315 mm με διακλαδώσεις 45° ή 87° διατομής Ø60 – 250 mm,
- **Παραλλαγή 2** - Ομόκεντροι άκαμπτοι σωλήνες και εξαρτήματα PPH/ανοξειδωτος χάλυβα με λευκή ηλεκτροστατική βαφή διατομής Ø110/160 – 200/300 mm με διακλαδώσεις 87° διατομής Ø60/100 – 125/180 mm,.

Προορίζονται για σύνδεση συσκευών σε σειρά εσωτερικού χώρου και η σύσνδεση των εξωτερικών αγωγών γίνεται με συνδέσμους υποδοχής με παρέμβυσμα EPDM.

### ZUB

Εξαρτήματα για συστήματα καπνοδόχων (neutroboxes, clips, θυρίδες καθαρισμού, αντλίες συμπυκνωμάτων, κτλ.)

# ΣΥΣΤΗΜΑ ΚΑΠΝΟΔΟΧΟΥ ALMEVA

## ΣΗΜΑΝΣΗ ΣΤΟΙΧΕΙΩΝ ΣΥΣΤΗΜΑΤΟΣ

ALMEVA

Όλα τα μέρη μίας καπνοδόχου ενός συστήματος Almeva κατατάσσονται, σύμφωνα με το πρότυπο EN1443, που ορίζει τις γενικές απαιτήσεις και τις βασικές συνθήκες λειτουργίας για καπνοδόχους και έχει σημειωθεί σύμφωνα με το πρότυπο EN 14471 του οποίου το θέμα είναι η αξιολόγηση των χαρακτηριστικών των συστημάτων καπνοδόχων με πλαστικούς αγωγούς. Η σήμανση των σωλήνων γίνεται συνήθως τυπώνοντας κατά μήκος τους όλα τα απαιτούμενα στοιχεία. Τα εξαρτήματα έχουν την λεγόμενη «επισήμανση αναγνώρισης» (περίληψη των απαιτούμενων στοιχείων είναι χαραγμένα στην υποδοχή τους).

Ολόκληρο το σύστημα και όλα τα επιμέρους εξαρτήματα είναι πιστοποιημένα, και φέρουν το σύμβολο CE που αντιστοιχεί στην οδηγία 93/68/ΕΚ. Το εν λόγω σύμβολο CE μαζί με τον αριθμό του πιστοποιητικού 0036 CPD 9165 001 τοποθετούνται σε κάθε ένα εξάρτημα με την μορφή αυτοκόλλητου.

Κάθε καπνοδόχος πρέπει να φέρει αυτοκόλλητη ετικέτα στην οποία να διακρίνονται οι σχετικές διαδρομές καυσαερίων σύμφωνα με τα αντίστοιχα πρότυπα. Οι ετικέτες πρέπει να είναι μόνιμες και ευδιάκριτες, κατασκευασμένες από ανθεκτικό υλικό και να είναι τοποθετημένες σε ορατό σημείο. Περιλαμβάνουν το όνομα της εταιρίας ή το σήμα του κατασκευαστή, σήμανση σύμφωνα με το πρότυπο EN 14471, ονομαστική διάμετρο και θερμική αντίσταση της καπνοδόχου, κατασκευαστή και τύπο συσκευών, ισχύ συσκευών και πληροφορίες του εγκαταστάτη (διεύθυνση, τηλέφωνο, κτλ.), ημερομηνία και αριθμό αδείας εγκαταστάτη.



### Παράδειγμα σήμανσης σωλήνα:

Almeva NW 60x2.0 EN 14471 0036 CPD 9165 001 VKF 14700 T120 H1 0 W 1 020 I E L0 36/15

### Παράδειγμα σήμανσης εξαρτήματος:

Almeva® CE EN 14471  
VKF Z 14700 T120 H1  
CE 0036 CPD 9165 001

### Ετικέτα καπνοδόχου:

 almeva Hellas O.E. Ζακύνθου 12 & Σύρου, Τ.Κ.144 52, Μεταμόρφωση, Αθήνα, Ελλάδα τηλ.: (+30) 210 2322970 Α.Φ.Μ.: 998236470 Γ.Ε.ΜΗ.: 008117201000, Δ.Ο.Υ.: Νέας Ιωνίας web: www.almeva.gr   e-mail: info@almeva.gr	
Καπνοδόχος μονού τοιχώματος ALMEVA EASY <b>EN 14471:2013+A1:2015</b>	Καπνοδόχος διπλού τοιχώματος ALMEVA DOUBLE <b>EN 14471:2013+A1:2015</b>
<ul style="list-style-type: none"><li>○ T120 H1 W 2 O20 LI E U (Λευκό DN80)</li><li>○ T120 H1 W 2 O20 LE E U (έως DN160)</li><li>○ T120 P1 W 2 O20 LE E U (από DN200)</li><li>○ T120 P1 W 2 O20 LI E U (Flex RAL 7032 έως DN200)</li><li>○ T120 H1 W 2 O20 LI E U (Flex RAL 9005 έως DN100)</li><li>○ T120 P1 W 2 O20 LI E U (Flex RAL 9005 από DN125)</li></ul>	<ul style="list-style-type: none"><li>○ T120 H1 W 2 O00 LI E U1 (LJK έως DN160)</li><li>○ T120 P1 W 2 O00 LI E U1 (LJK από DN200)</li><li>○ T120 H1 W 2 O00 LI E U0 (LIB/LIL έως DN160)</li><li>○ T120 P1 W 2 O00 LI E U0 (LIB/LIL από DN200)</li><li>○ T120 H1 W 2 O00 LE E U0 (LAB/LAL/LAC/LAM ≤ DN160)</li><li>○ T120 P1 W 2 O00 LE E U0 (LAB/LAL/LAC/LAM ≥ DN200)</li></ul>
Θερμική αντίσταση καμινάδας 0,00 m <sup>2</sup> .K.W <sup>-1</sup>	
Όνομαστική διάμετρος: mm	Όνομαστική διάμετρος: mm
Στοιχεία εγκαταστάτη, διεύθυνση, τηλ.:	
Κατασκευαστής και τύπος συσκευών:	
Πλήρης ονομαστική ισχύς συσκευών:	
Ημερομηνία εγκατάστασης:	
Αριθμός αδείας εγκαταστάτη:	
	
<b>ΕΙΔΟΠΟΙΗΣΗ:</b> Η ετικέτα της καπνοδόχου πρέπει να είναι τοποθετημένη σε ευδιάκριτο σημείο επάνω στους καπνοαγωγούς Almeva, να παραμένει πάντα ευανάγνωστη, δεν πρέπει να είναι βαμμένη, να μην αφαιρεθεί ή να φθαρεί με οποιονδήποτε τρόπο!	

## ΥΛΙΚΑ

### Πλαστικοί άκαμπτοι σωλήνες, εύκαμπτοι σωλήνες και εξαρτήματα

Βασικό υλικό κατασκευής είναι το ομοπολυμερές πολυπροπυλένιο (PPH). Πρόκειται για μία θερμοπλαστική ουσία υψηλού μοριακού βάρους, μερικά κρυσταλλική με πυκνότητα σημαντικά χαμηλότερη από άλλα πλαστικά που χρησιμοποιούνται και κυμαίνεται από 0.90-0.91 g.cm<sup>3</sup>. Η επιφάνεια του δεν είναι διαλυτή, δεν διογκώνεται και έτσι η χρήση κόλλας καθίσταται πολύ δύσκολη. Από την άλλη, είναι πολύ εύκολο να συγκολληθεί. Το PPH είναι ανθεκτικό στο χρόνο και γι' αυτό τα υλικά του συστήματος έχουν μεγάλη διάρκεια ζωής. Χαρακτηρίζεται από την εξαιρετική του χημική αντίσταση σε οξέα (εκτός από οξειδωτικά οξέα), αλκαλικά και ελαφρά διαλυτικά. Έχει μεγάλη αντοχή σε καιρικά φαινόμενα και μικροοργανισμούς, διαθέτει αποδεκτή φυσιολογία ωστόσο, δεν είναι ανθεκτικό στην ακτινοβολία UV. Σε σύγκριση με άλλα κοινά πλαστικά έχει πολύ καλή επιφανειακή σκληρότητα και επαρκή ελαστικότητα σε χαμηλές θερμοκρασίες.

Το PPH επίσης χαρακτηρίζεται από καλή αντοχή κρούσης, καλές ηλεκτρομονωτικές ιδιότητες με πρακτικά μηδενική απορρόφηση συμπυκνωμάτων και υψηλή βραχυπρόθεσμη μεταφορά θερμότητας 140 °C. Επίσης, έχει πολύ χαμηλή θερμική αγωγιμότητα (μόνο 0.22 W/mK), με αποτέλεσμα να μην προκαλείται μεγάλη μείωση της θερμοκρασίας καυσαερίων μέσα στις σωληνώσεις, όπως συμβαίνει π.χ. στις ανοξειδωτες. Το PPH ανήκει στα θερμοπλαστικά και γι' αυτό όταν θερμαίνεται ή ψύχεται, διατηρεί τις εξαιρετικές του ιδιότητες. Οι σωλήνες PPH σε μαύρο χρώμα είναι προστατευμένοι από την υπεριώδη ακτινοβολία σύμφωνα με το EN ISO 8256:2004.

### Στεγανοποίηση

Δακτύλιοι τύπου o-ring, κυκλικό ή με πτερύγια καθώς και άλλα υλικά του συστήματος σφράγισης κατασκευάζονται από αιθυλένιο – προπυλένιο – διένιο – καουτσούκ – M class (EPDM) και τοποθετούνται σε όλους τους σωλήνες και τα εξαρτήματα κατά την γραμμή παραγωγής. Πρόκειται για ένα ελαστομερές υλικό υψηλής ποιότητας με αντίσταση έναντι των αποτελεσμάτων των συμπυκνωμάτων, της υψηλής θερμοκρασίας (βραχυπρόθεσμα έως 150 °C), την αντίσταση στη γήρανση, στην οξείδωση, στο όζον και στις ατμοσφαιρικές επιδράσεις. Αυτό το ανθεκτικό στα οξέα ελαστικό έχει επίσης πολύ καλή αντοχή στα χημικά σαν οργανικό υλικό (συμπεριλαμβανομένου και του διοξειδίου του άνθρακα), αλλά και στις πολικές οργανικές ενώσεις. Ωστόσο, το EPDM πολύ κακή αντίσταση στο αργό πετρέλαιο.

### Εξωτερική επίστρωση και εξαρτήματα στερέωσης

Οι εξωτερικοί αγωγοί των συστημάτων LIB, LAB και LAM, μαζί με τα εξαρτήματα στερέωσης είναι κατασκευασμένα από εξαιρετικά στιλβωμένο κατασκευαστικό χάλυβα αρ.1.4301 (σήμανση σύμφωνα με το EN ISO X5CrNi18-10). Αυτός ο ωστενικός ανοξειδωτος χάλυβας, χρωμίου – νικελίου, είναι εύκολος στη συγκόλληση, ανακυκλώνεται, έχει καλή ολκιμότητα, αντίσταση στη φθορά και μακροχρόνια αντοχή σε θερμοκρασίες έως 300 °C. Ο χάλυβας είναι ανθεκτικός στο νερό, στον ατμό, στην υγρασία του αέρα και σε ασθενή οργανικά ή ανόργανα οξέα.

Οι εξωτερικοί αγωγοί του συστήματος LAC μαζί με τα εξαρτήματα στερέωσης είναι κατασκευασμένα από το ίδιο υλικό των συστημάτων LIB και LAB. Στη συνέχεια επικαλύπτονται γαλβανικά με ένα στρώμα χαλκού, εξασφαλίζοντας έτσι την ίδια οπτική εμφάνιση και καθαρότητα με τον πραγματικό χαλκό.

Οι εξωτερικοί αγωγοί των συστημάτων LIL και LAL, μαζί με τα εξαρτήματα στερέωσης είναι κατασκευασμένα από φερριτικό ανοξειδωτο χάλυβα αρ. 1.4509 (σήμανση σύμφωνα με το EN ISO X3CrTi17). Αυτός ο χάλυβας είναι κατάλληλος για ψυχρή διαμόρφωση (έλαση) και για επιφανειακή επεξεργασία με την χρήση βερνικιού, βαφής ή επισμάλτωσης. Λόγο αυτών των ιδιοτήτων, η επιφάνεια όλων των εξαρτημάτων των συστημάτων LIL και LAL που είναι βαμμένα με λευκή ηλεκτροστατική βαφή έχουν εγγυημένη προστασία από τις εξωτερικές επιδράσεις, καθώς και αισθητική λειτουργία.

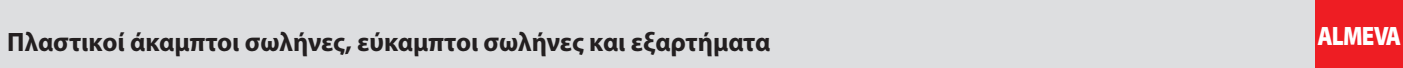

# RIGID GAS FLUE SYSTEM

STARRES ABGASSYSTEM

SISTEMA DE EVACUACIÓN PARA EL INTERIOR - RÍGIDO

SERT GAZ BACA SİSTEMİ STARR

ΑΚΑΜΠΤΟ ΣΥΣΤΗΜΑ ΚΑΠΝΟΔΟΧΟΥ

**Ø60 – 315 mm**

**STARR**

**PPH – black**

PPH – schwarz

PPH – negro

PPH – siyah

PPH – μαύρο

STARR

1	PPSAS5
2	PBRM15
3	TTAD01
4	PPFR60
5	PBTU05
6	ZUBL05
7	PBRD5
8	PBRTA5
9	PBUD5
10	PBKA51

STARR			
Ø (mm)	Inner dimension of socket Innenmass des Rohres Dimensión interior del tubo Soketin iç boyutu Εσωτερική διάτομή υποδοχής (mm)	Wall thickness Wandstärke Espesor de pared Duvar kalınlığı Πάχος τοιχώματος (mm)	Outer dimension of socket Ausßenmass der Muffe Dimensión exterior del manguito Soketin dış boyutu Εξωτερική διάτομή υποδοχής (mm)
60	56	2,0	75
80	76	2,0	95
100	95	2,5	115
110	104	2,5	127
125	118	3,0	145
160	152	3,5	182
200	189	4,0	230
250	242	4,0	295
315	304	6,0	360



**When connecting pipes always use a silicone lubricant Almeva.**

Auf ordnungsgem. Steckbarkeit der Verbindungen achten - ggf. mit Almeva Gleitmittel vorbehandeln.

Al conectar las tuberías, utilice siempre el lubricante de silicona Almeva.

Boruları bağlarken her zaman silikon yağlayıcı Almeva kullanın.

Όταν συνδέετε σωλήνες πρέπει πάντα να χρησιμοποιείτε λιπαντικό Almeva.

**Before connecting, verify the correct placement of the seal.**

Dichtungssitz prüfen.

Antes de conectar, verifique la correcta colocación de la junta.

Bağlamadan önce, contanın doğru yerleştirildiğini doğrulayın.

Πριν συνδέσετε βεβαιωθείτε για την σωστή θέση του παρεμβύσματος.

**When assembling horizontal piping, it is necessary to create a slope towards the boiler at minimum of 3°.**

Gefälle schaffen waagerechte Verbindungsleitung muss zum Kessel immer ein Gefälle von mindestens 3° haben.

Al montar las tuberías horizontales, es necesario crear una pendiente hacia la caldera de un mínimo de 3°.

Yatay boru tesisatını monte ederken, kazana doğru en az 3°'lik bir eğim oluşturmak gerekir.

Κατά την εγκατάσταση οριζόντιων σωληνώσεων, πρέπει να υπάρχει κλίση προς τον λέβητα τουλάχιστον 3°.

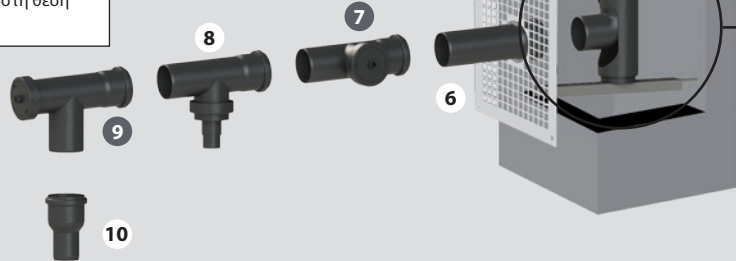
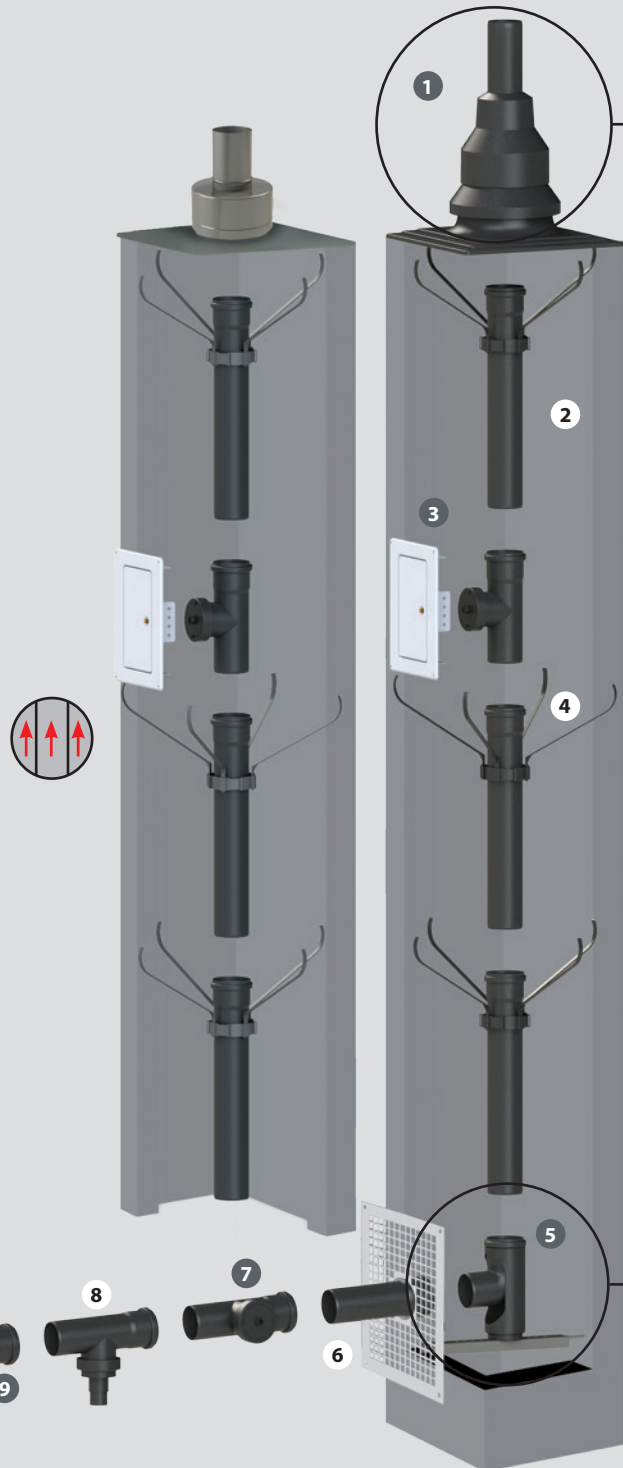

## RIGID GAS FLUE SYSTEM

STARRES ABGASSYSTEM

SISTEMA DE EVACUACIÓN PARA EL INTERIOR - RÍGIDO

SERT GAZ BACA SİSTEMİ STARR

ΑΚΑΜΠΤΟ ΣΥΣΤΗΜΑ ΚΑΠΝΟΔΟΧΟΥ

**Ø60 – 315 mm**

**STARR**

**PPH – black**

PPH – schwarz

PPH – negro

PPH – siyah

PPH – μαύρο

STARR

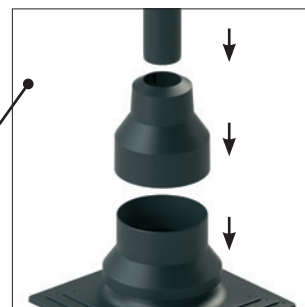
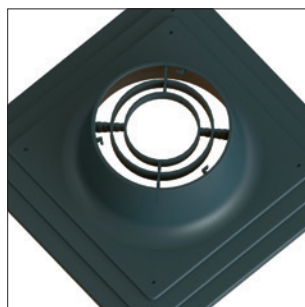

**Insert black end pipe into the socket of PPH pipe and then pull over it tapered rain collar.**

Mündungsrohr des Dachaufsatzes in die Muffe des PPH-Rohres einstecken und Wetterkragen überstülpen.

Introducir el tubo terminal en el manguito del tubo PPH y tajar el cubreaguas con el collarín.

Siyah uçlu boruyu PPH borunun yuvasına yerleştirin ve ardından konik yağmur bileziğinin üzerinden çekin.

Τοποθετήστε το μαύρο τερματικό σωλήνα στην υποδοχή του σωλήνα PPH και σύρετε πάνω του το κωνικό προστατευτικό βροχής

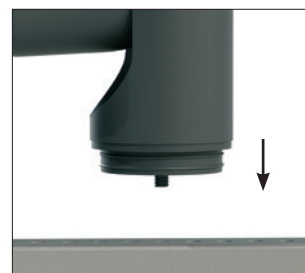
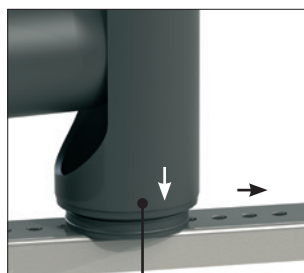

**Insert the peg of the heel elbow into required opening of a brace and anchor.**

Den Noppen der Stütztulpe in die erforderliche Öffnung der Auflageschiene einrasten.

Anclar la clavija de la base de apoyo en la posición requerida de la tablilla.

Topuk dirseğinin mandalını bir destek ve ankrajın gerekli açıklığına yerleştirin.

Εισάγετε την ακίδα της καμπύλης στερέωσης στο κατάλληλο άνοιγμα της λάμας αγκύρωσης

# RIGID GAS FLUE SYSTEM

STARRES ABGASSYSTEM

SISTEMA DE EVACUACIÓN PARA EL INTERIOR - RÍGIDO

SERT GAZ BACA SİSTEMİ STARR

ΑΚΑΜΠΤΟ ΣΥΣΤΗΜΑ ΚΑΠΝΟΔΟΧΟΥ

**Ø60 – 315 mm**

**STARR**

**PPH – black**

PPH – schwarz

PPH – negro

PPH – siyah

PPH – μαύρο

STARR

**Minimum size of the shaft for the rigid gas flue system (co-current air/combustion gases).**

Mindestabstände Ringspalt Starres Abgassystem (Luft/Verbrennungsgase im Gleichstrom).  
Dimensiones mínimas del conducto de la chimenea para el sistema rígido STARR (combustión aire/gases).  
Sert gaz baca sistemi için minimum shaft boyutu (eş akımlı hava/yanma gazları).  
Ελάχιστο μέγεθος φρεατίου για το άκαμπτο σύστημα καπνοδόχων (παράλληλη ροή αέρα/καυσαερίων).

**It is necessary to consider the size of the socket where the profile of the flow of the air is narrower.**  
Der engere Luftstromraum muss berücksichtigt werden.  
Es necesario considerar el espacio más estrecho del flujo de aire.  
Hava akış profilinin daha dar olduğu soket boyutunu dikkate almak gerekir.  
Είναι απαραίτητο να λάβετε υπόψη το μέγεθος της υποδοχής εκεί που το προφίλ της ροής του αέρα είναι στενότερο.

## 4 Variants of appliance connection

Kesselanschlüsse in 4 Varianten  
4 Variantes de aplicación

4 Cihaz bağlantısının varyantları  
4 παραλλαγές σύνδεσης συσκευών

Variant I / II		Variant III		Variant IV	
Variante I / II	Varyant I / II	Variante III	Varyant III	Variante IV	Varyant IV
Variante I / II	Παραλλαγή I / II	Variante III	Παραλλαγή III	Variante IV	Παραλλαγή IV
<b>STARR boiler adapter centric/excentric</b>		<b>STARR boiler adapter with test plug</b>		<b>STARR boiler adapter-Tee with test plug (reduced)</b>	
STARR Kesselanschluss konzentrisch/exzentrisch	STARR kazan adaptörü merkezli / ek merkezli	STARR Kesselanschluss m. MÖ	STARR kazan adaptörü test fişi ile	STARR Umlenk-T m. MÖ als KA	STARR kazan adaptörü-Tee test ile fiş (azaltılmış)
STARR Adaptador a caldera céntrico/excéntrico	STARR συστολή λέβητα ομοκεντρική/έκκεντρη	STARR Adaptador a caldera con toma de muestras	STARR συστολή λέβητα με σημείο μέτρησης	STARR T-Adapt. caldera con tm. de muestras (reducida)	STARR Ταφ σύνδεσης λέβητα με σημείο μέτρησης (συστολικό)
<p>Ø <b>(combustion gas piping)</b> (Abgasleitung) (tubos combustión humos) (yanma gazı boru tesisatı) (σωλήνες καυσαερίων)</p> <p>60, 80, 100, 110, 125, 160, 200, 250, 315</p>		<p>Ø <b>(combustion gas piping)</b> (Abgasleitung) (tubos combustión humos) (yanma gazı boru tesisatı) (σωλήνες καυσαερίων)</p> <p>60, 80, 100, 110, 125, 160, 200, 250, 315</p>		<p>Ø <b>(combustion gas piping)</b> (Abgasleitung) (tubos combustión humos) (yanma gazı boru tesisatı) (σωλήνες καυσαερίων)</p> <p>60, 80, 100, 110, 125, 160, 200, 250, 315</p>	
<p>Ø <b>(socket of the appliance)</b> (Kesselstutzen) (aplicación a caldera) (cihazın soketi) (υποδοχή συσκευής)</p> <p>50, 60, 63, 70, 75, 80, 100, 110, 125, 130, 150, 153, 160, 180, 200, 225, 250, 300</p>		<p>Ø <b>(socket of the appliance)</b> (Kesselstutzen) (aplicación a caldera) (cihazın soketi) (υποδοχή συσκευής)</p> <p>50, 60, 63, 70, 75, 80, 100, 110, 125, 130, 150, 153, 160, 180, 200, 225, 250, 300</p>		<p>Ø <b>(socket of the appliance)</b> (Kesselstutzen) (aplicación a caldera) (cihazın soketi) (υποδοχή συσκευής)</p> <p>50, 60, 63, 70, 75, 80, 100, 110, 125, 130, 150, 153, 160, 180, 200, 225, 250, 300</p>	

The exact dimension and Variant of the appliance connection can be found on pg. 44-47.

Die genauen Dimensionierungen und Übergänge finden Sie auf den Seiten 44-47.  
Las dimensiones exactas y variantes de aplicación se encuentran en las páginas 44-47.

Cihaz bağlantısının tam boyutu ve Varyantı sf. 44-47'de bulunabilir.  
Η ακριβής διάσταση και το είδος της υποδοχής της συσκευής υπάρχουν στις σελίδες 44-47.

# RIGID GAS FLUE SYSTEM

STARRES ABGASSYSTEM

SISTEMA DE EVACUACIÓN PARA EL INTERIOR - RÍGIDO

SERT GAZ BACA SİSTEMİ STARR

ΑΚΑΜΠΤΟ ΣΥΣΤΗΜΑ ΚΑΠΝΟΔΟΧΟΥ

**Ø60 – 315 mm**

**STARR**

**PPH – black**

PPH – schwarz

PPH – negro

PPH – siyah

PPH – μαύρο

STARR

## STARR Pipe with socket

STARR Rohr mit Muffe • STARR Tubo rígido M/H • STARR Soketli boru • STARR Σωλήνα με υποδοχή (κεφάλι)

Ø	Code Código	Kod Κωδ.	a (mm)	b (mm)	c (mm)	d (mm)	i
250 mm	60	PBRM05	61	55	195	-	
	80	PBRM08	81	62	188	-	
	100	PBRM0X	101	63	187	-	
	110	PBRM01	111	73	227	-	
	125	PBRM02	127	75	245	-	
	160	PBRM06	162	85	295	-	
	200	PBRM00	203	150	250	-	
	250	PBRM0V	254	260	250	-	
	315	PBRM03	319	290	250	-	
500 mm	60	PBRM55	61	55	445	-	
	80	PBRM58	81	62	438	-	
	100	PBRM5X	101	63	437	-	
	110	PBRM51	111	73	427	-	
	125	PBRM52	127	75	425	-	
	160	PBRM56	162	85	415	-	
	200	PBRM50	203	150	500	-	
	250	PBRM5V	254	260	500	-	
	315	PBRM53	319	290	500	-	
1000 mm	60	PBRM15	61	55	945	-	
	80	PBRM18	81	62	938	-	
	100	PBRM1X	101	63	937	-	
	110	PBRM11	111	73	927	-	
	125	PBRM12	127	75	925	-	
	160	PBRM16	162	85	915	-	
	200	PBRM10	203	150	850	-	
	250	PBRM1V	254	260	740	-	
	315	PBRM13	319	290	710	-	
2000 mm	60	PBRM25	61	55	1945	-	
	80	PBRM28	81	62	1938	-	
	100	PBRM2X	101	63	1937	-	
	110	PBRM21	111	73	1927	-	
	125	PBRM22	127	75	1925	-	
	160	PBRM26	162	85	1915	-	
	200	PBRM20	203	150	1850	-	
	250	PBRM2V	254	260	1740	-	
	315	PBRM23	319	290	1710	-	

## STARR Inspection-Tee with inspection door with control lid

STARR Revisions-T m. Rev.-Deckel • STARR Te-Inspección • STARR Inspection-Tee, kontrol kapaklı denetim kapısı ile • STARR Ταφ με θυρίδα επιθεώρησης

Ø	Code Código	Kod Κωδ.	a (mm)	b (mm)	c (mm)	d (mm)	i
60	PBRTD5		61	65	220	40	
80	PBRTD8		81	62	270	45	
100	PBRTDX		101	63	187	105	
110	PBRTD1		111	73	237	60	
125	PBRTD2		127	75	325	50	
160	PBRTD6		162	85	300	145	
200	PBRTD0		203	150	350	190	
250	PBRTDV		254	260	)	)	
315	PBRTD3		319	290			

Please, contact technical department • Bitte wenden Sie sich an unsere technische Abteilung • Por favor, contacte nuestro departamento técnico • Lütfen teknik departmanla iletişime geçin • Επικοινωνήστε με το τεχνικό τμήμα

# RIGID GAS FLUE SYSTEM

STARRES ABGASSYSTEM

SISTEMA DE EVACUACIÓN PARA EL INTERIOR - RÍGIDO

SERT GAZ BACA SİSTEMİ STARR

ΑΚΑΜΠΤΟ ΣΥΣΤΗΜΑ ΚΑΠΝΟΔΟΧΟΥ

**Ø60 – 315 mm**

**STARR**

PPH – black

PPH – schwarz

PPH – negro

PPH – siyah

PPH – μαύρο

STARR

## STARR Inspection-Tee with drain

STARR Revisions-T m. Ablauf • STARR Te-Inspección con desc./cond. • STARR Drenajlı Muayene T'si • STARR Ταφ με θυρίδα επιθεώρησης και αποστράγγιση

Ø	Code Código	Kod Κωδ.	a (mm)	b (mm)	c (mm)	d (mm)	i
60	PBRTA5		61	55	220	125	
80	PBRTA8		81	62	270	162	
100	PBRTAX		101	63	187	155	
110	PBRTA1		111	73	237	174	
125	PBRTA2		127	75	325	180	
160	PBRTA6		162	85	300	205	
200	PBRTA0		203	150	350	240	
250	PBRTAV		254	260	)	)	
315	PBRTA3		319	290			

## STARR Deflection-Tee w. inspection

STARR Umlenk-T m. Rev.-Deckel • STARR Te-Desvío con inspección • STARR Saptırma-Tee w. denetimi • STARR Ταφ με θυρίδα επιθεώρησης με αλλαγή κατεύθυνσης

Ø	Code Código	Kod Κωδ.	a (mm)	b (mm)	c (mm)	d (mm)	i
60	PBUTD5		61	55	225	100	
80	PBUTD8		81	62	266	130	
100	PBUTDX		101	63	232	155	
110	PBUTD1		111	73	280	160	
125	PBUTD2		127	75	330	150	
160	PBUTD6		162	85	320	180	
200	PBUTD0		203	150	370	230	
250	PBUTDV		254	260	)	)	
315	PBUTD3		319	290			

## STARR Deflection-Tee with test plug

STARR Umlenk-T m. MÖ • STARR Te-Desvío con tm/muestras • Test tapalı STARR Saptırma Keçesi • STARR Ταφ με θυρίδα επιθεώρησης με αλλαγή κατεύθυνσης και σημείο μέτρησης

Ø	Code Código	Kod Κωδ.	a (mm)	b (mm)	c (mm)	d (mm)	i
60	PBTM95		61	65	205	142	
80	PBTM98		81	65	245	161	
100	PBTM9X		101	63	272	195	
110	PBTM91		111	60	225	158	
125	PBTM92		127	75	315	225	
160	PBTM96		162	85	335	205	
200	PBTM90		203	150	390	250	
250	PBTM9V		254	260	)	)	
315	PBTM93		319	290			

## STARR Deflection-Tee with drain

STARR Umlenk-T m. Ablauf • STARR Te-Desvío con desc./cond. • STARR Drenajlı Saptırma T'si • STARR Ταφ με θυρίδα επιθεώρησης με αλλαγή κατεύθυνσης και αποστράγγιση

Ø	Code Código	Kod Κωδ.	a (mm)	b (mm)	c (mm)	d (mm)	i
60	PBUTA5		61	55	270	155	
80	PBUTA8		81	62	346	194	
100	PBUTAX		101	63	287	210	
110	PBUTA1		111	73	344	220	
125	PBUTA2		127	75	390	195	
160	PBUTA6		162	85	360	215	
200	PBUTA0		203	150	420	280	
250	PBUTAV		254	260	)	)	
315	PBUTA3		319	290			

Please, contact technical department • Bitte wenden Sie sich an unsere technische Abteilung • Por favor, contacte nuestro departamento técnico • Lütfen teknik departmanla iletişime geçin • Επικοινωνήστε με το τεχνικό τμήμα

# RIGID GAS FLUE SYSTEM

STARRES ABGASSYSTEM

SISTEMA DE EVACUACIÓN PARA EL INTERIOR - RÍGIDO

SERT GAZ BACA SİSTEMİ STARR

ΑΚΑΜΠΤΟ ΣΥΣΤΗΜΑ ΚΑΠΝΟΔΟΧΟΥ

**Ø60 – 315 mm**

**STARR**

PPH – black

PPH – schwarz

PPH – negro

PPH – siyah

PPH – μαύρο

STARR

**STARR Connecting-Tee**  
STARR Verbindungs-T • STARR Te-Empalme • STARR Bağlama-Keçe • STARR Ταφ σύνδεσης

Ø	Code Código	Kod Κωδ.	a (mm)	b (mm)	c (mm)	d (mm)	i
60	PBTE95		61	65	162	103	
80	PBTE98		81	65	197	113	
100	PBTE9X		101	63	187	110	
110	PBTE91		111	60	178	113	
125	PBTE92		127	75	248	162	
160	PBTE96		162	85	248	164	
200	PBTE90		203	150	410	250	
250	PBTE9V		254	260	}	}	
315	PBTE93		319	290			

**STARR Elbow 15°**  
STARR Bogen 15° • STARR Codo 15° • STARR Dirsek 15° • STARR Καμπύλη 15°

Ø	Code Código	Kod Κωδ.	a (mm)	b (mm)	c (mm)	d (mm)	i
60	PBSB15		61	55	60	72	
80	PBSB18		81	62	72	65	
100	PBSB1X		101	63	70	60	
110	PBSB11		111	73	89	72	
125	PBSB12		127	75	90	70	
160	PBSB16		162	85	100	90	
200	PBSB10		203	150	250	170	
250	PBSB1V		254	260	}	}	
315	PBSB13		319	290			

**STARR Elbow 30°**  
STARR Bogen 30° • STARR Codo 30° • STARR Dirsek 30° • STARR Καμπύλη 30°

Ø	Code Código	Kod Κωδ.	a (mm)	b (mm)	c (mm)	d (mm)	i
60	PBSB35		61	55	71	75	
80	PBSB38		81	62	87	69	
100	PBSB3X		101	63	80	70	
110	PBSB31		111	73	103	80	
125	PBSB32		127	75	105	80	
160	PBSB36		162	85	125	105	
200	PBSB30		203	150	245	205	
250	PBSB3V		254	260	}	}	
315	PBSB33		319	290			

**STARR Elbow 45°**  
STARR Bogen 45° • STARR Codo 45° • STARR Dirsek 45° • STARR Καμπύλη 45°

Ø	Code Código	Kod Κωδ.	a (mm)	b (mm)	c (mm)	d (mm)	i
60	PBSB45		61	55	80	86	
80	PBSB48		81	62	97	80	
100	PBSB4X		101	63	90	85	
110	PBSB41		111	73	128	87	
125	PBSB42		127	75	145	100	
160	PBSB46		162	85	160	130	
200	PBSB40		203	150	240	195	
250	PBSB4V		254	260	}	}	
315	PBSB43		319	290			

**⌋** Please, contact technical department • Bitte wenden Sie sich an unsere technische Abteilung • Por favor, contacte nuestro departamento técnico • Lütfen teknik departmanla iletişime geçin • Επικοινωνήστε με το τεχνικό τμήμα

# RIGID GAS FLUE SYSTEM

STARRES ABGASSYSTEM

SISTEMA DE EVACUACIÓN PARA EL INTERIOR - RÍGIDO

SERT GAZ BACA SİSTEMİ STARR

ΑΚΑΜΠΤΟ ΣΥΣΤΗΜΑ ΚΑΠΝΟΔΟΧΟΥ

**Ø60 – 315 mm**

**STARR**

PPH – black

PPH – schwarz

PPH – negro

PPH – siyah

PPH – μαύρο

STARR

## STARR Elbow 60°

STARR Bogen 60° • STARR Codo 60° • STARR Dirsek 60° • STARR Καμπύλη 60°

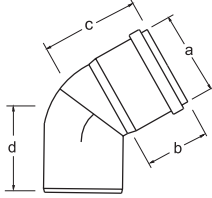

Ø	Code Código	Kod Κωδ.	a (mm)	b (mm)	c (mm)	d (mm)	i
60	PBSB65		61	55	85	85	
80	PBSB68		81	62	90	80	
100	PBSB6X		101	63	110	100	
110	PBSB61		111	73	105	95	
125	PBSB62		127	75	115	110	
160	PBSB66		162	85	130	120	
200	PBSB60		203	150	255	215	
250	PBSB6V		254	260	)	)	
315	PBSB63		319	290			

## STARR Elbow 87°

STARR Bogen 87° • STARR Codo 87° • STARR Dirsek 87° • STARR Καμπύλη 87°

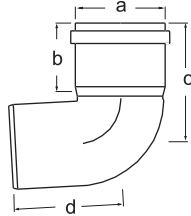

Ø	Code Código	Kod Κωδ.	a (mm)	b (mm)	c (mm)	d (mm)	i
60	PBSB95		61	55	130	103	
80	PBSB98		81	62	105	100	
100	PBSB9X		101	63	120	110	
110	PBSB91		111	73	135	120	
125	PBSB92		127	75	145	130	
160	PBSB96		162	85	165	150	
200	PBSB90		203	150	300	260	
250	PBSB9V		254	260	)	)	
315	PBSB93		319	290			

## STARR Elbow 87° with test plug

STARR Bogen 87° m. MÖ • STARR Codo 87° con tm/muestras • STARR Dirsek 87° test tapalı • STARR Καμπύλη 87° με σημείο μέτρησης

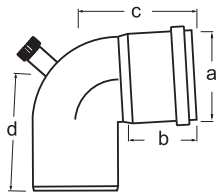

Ø	Code Código	Kod Κωδ.	a (mm)	b (mm)	c (mm)	d (mm)	i
60	PBSBM5		61	55	130	103	
80	PBSBM8		81	62	105	100	
100	PBSBMX		101	63	120	110	
110	PBSBM1		111	73	135	120	
125	PBSBM2		127	75	145	130	
160	PBSBM6		162	85	165	150	
200	PBSBM0		203	150	300	260	
250	PBSBMV		254	260	)	)	
315	PBSBM3		319	290			

## STARR Inspection elbow 45°

STARR Revisionsbogen 45° • STARR Codo inspección 45° • STARR Muayene dirseği 45° • STARR Καμπύλη επιθεώρησης 45°

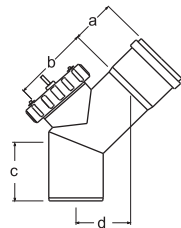

Ø	Code Código	Kod Κωδ.	a (mm)	b (mm)	c (mm)	d (mm)	i
60	PBRB45		55	85	55	90	
80	PBRB48		62	125	85	105	
100	PBRB4X		63	105	80	60	
110	PBRB41		73	105	59	47	
125	PBRB42		75	115	70	70	
160	PBRB46		85	130	65	70	
200	PBRB40		150	170	180	230	
250	PBRB4V		)	)	)	)	
315	PBRB43						

) | Please, contact technical department • Bitte wenden Sie sich an unsere technische Abteilung • Por favor, contacte nuestro departamento técnico • Lütfen teknik departmanla iletişime geçin • Επικοινωνήστε με το τεχνικό τμήμα

# RIGID GAS FLUE SYSTEM

STARRES ABGASSYSTEM

SISTEMA DE EVACUACIÓN PARA EL INTERIOR - RÍGIDO

SERT GAZ BACA SİSTEMİ STARR

ΑΚΑΜΠΤΟ ΣΥΣΤΗΜΑ ΚΑΠΝΟΔΟΧΟΥ

**Ø60 – 315 mm**

**STARR**

PPH – black

PPH – schwarz

PPH – negro

PPH – siyah

PPH – μαύρο

STARR

**STARR Inspection elbow 45° (left)**  
STARR Revisionsbogen 45° (seitl. links) • STARR Codo inspección 45° izquierda • STARR Muayene dirseği 45° (sol) • STARR Καμπύλη επιθεώρησης 45° (δεξιά)

Ø	Code Código	Kod Κωδ.	a (mm)	b (mm)	c (mm)	d (mm)	i
60	PBRL45		55	150	50	110	
80	PBRL48		62	125	68	105	
100	PBRL4X		63	145	80	100	
110	PBRL41		73	155	104	90	
125	PBRL42		75	170	105	120	
160	PBRL46		85	180	110	170	
200	PBRL40		150	200	150	180	
250	PBRL4V		)	)	)	)	
315	PBRL43		)	)	)	)	

**STARR Inspection elbow 45° (right)**  
STARR Revisionsbogen 45° (seitl. rechts) • STARR Codo inspección 45° dcha. • STARR Muayene dirseği 45° (sağ) • STARR Καμπύλη επιθεώρησης 45° (αριστερή)

Ø	Code Código	Kod Κωδ.	a (mm)	b (mm)	c (mm)	d (mm)	i
60	PBRR45		55	150	50	110	
80	PBRR48		62	125	68	105	
100	PBRR4X		63	145	80	100	
110	PBRR41		73	155	104	90	
125	PBRR42		75	170	105	120	
160	PBRR46		85	180	110	170	
200	PBRR40		150	200	150	180	
250	PBRR4V		)	)	)	)	
315	PBRR43		)	)	)	)	

**STARR Inspection elbow 87°**  
STARR Revisionsbogen 87° • STARR Codo inspección 87° • STARR Muayene dirseği 87° • STARR Καμπύλη επιθεώρησης 87°

Ø	Code Código	Kod Κωδ.	a (mm)	b (mm)	c (mm)	d (mm)	i
60	PBRB95		61	55	130	85	
80	PBRB98		81	62	155	135	
100	PBRB9X		101	63	90	115	
110	PBRB91		111	73	130	125	
125	PBRB92		127	75	130	125	
160	PBRB96		162	85	95	150	
200	PBRB90		203	150	190	280	
250	PBRB9V		254	260	)	)	
315	PBRB93		319	290	)	)	

**STARR Inspection elbow 87° (left)**  
STARR Revisionsbogen 87° (seitl. links) • STARR Codo inspección 87° izquierda • STARR Muayene dirseği 87° (sol) • STARR Καμπύλη επιθεώρησης 87° (δεξιά)

Ø	Code Código	Kod Κωδ.	a (mm)	b (mm)	c (mm)	d (mm)	i
60	PBRL95		55	70	95	-	
80	PBRL98		62	80	155	-	
100	PBRL9X		63	90	155	-	
110	PBRL91		73	145	210	-	
125	PBRL92		75	165	170	-	
160	PBRL96		85	200	210	-	
200	PBRL90		150	210	260	-	
250	PBRL9V		)	)	)	-	
315	PBRL93		)	)	)	-	

**) | Please, contact technical department • Bitte wenden Sie sich an unsere technische Abteilung • Por favor, contacte nuestro departamento técnico • Lütfen teknik departmanla iletişime geçin • Επικοινωνήστε με το τεχνικό τμήμα**

# RIGID GAS FLUE SYSTEM

STARRES ABGASSYSTEM

SISTEMA DE EVACUACIÓN PARA EL INTERIOR - RÍGIDO

SERT GAZ BACA SİSTEMİ STARR

ΑΚΑΜΠΤΟ ΣΥΣΤΗΜΑ ΚΑΠΝΟΔΟΧΟΥ

**Ø60 – 315 mm**

**STARR**

**PPH – black**

PPH – schwarz

PPH – negro

PPH – siyah

PPH – μαύρο

STARR

## STARR Inspection elbow 87° (right)

STARR Revisionsbogen 87° (seitl. rechts) • STARR Codo inspección 87° dcha. • STARR Muayene dirseği 87° (sağ) • STARR Καμπύλη επιθεώρησης 87° (αριστερή)

Ø	Code Código	Kod Κωδ.	a (mm)	b (mm)	c (mm)	d (mm)	i
60	PBRR95		55	60	70	-	
80	PBRR98		62	80	155	-	
100	PBRR9X		63	90	155	-	
110	PBRR91		73	145	210	-	
125	PBRR92		75	165	170	-	
160	PBRR96		85	200	210	-	
200	PBRR90		150	210	260	-	
250	PBRR9V		)	)	)	-	
315	PBRR93		)	)	)	-	

## STARR Chimney support elbow 87° w. anchoring

STARR Stütztulpe m. Auflage+Bogen • STARR Codo soporte chimenea 87° c. anclaje • STARR Baca destek dirseği 87° w. ankraj • STARR Καμπύλη στερέωσης 87° με αγκύρωση

Ø	Code Código	Kod Κωδ.	a (mm)	b (mm)	c (mm)	d (mm)	i
60	PBTU05		120	60	330	50	
80	PBTU08		120	60	330	50	
100	PBTU0X		205	145	330	50	
110	PBTU01		185	125	330	50	
125	PBTU02		195	125	700	50	
160	PBTU06		285	190	350	50	
200	PBTU00		345	220	700	50	
250	PBTU0V		)	)	700	50	
315	PBTU03		)	)	700	50	
-	-		-	-	-	-	
-	-		-	-	-	-	

## STARR Chimney support elbow 87° w. a thorn and anchoring

STARR Bogen 87° m. Auflage • STARR Codo soporte chimenea 87° c. anclaje • STARR Baca destek dirseği 87° w. ankraj • STARR Καμπύλη στερέωσης 87° ακίδας με αγκύρωση

Ø	Code Código	Kod Κωδ.	a (mm)	b (mm)	c (mm)	d (mm)	i
60	PBTUB5		-	-	-	-	
80	PBTUB8		-	-	-	-	
-	-		-	-	-	-	
-	-		-	-	-	-	
-	-		-	-	-	-	
-	-		-	-	-	-	

## STARR Chimney support elbow 87° w. anchoring (reduced)

STARR Stütztulpe m. Auflage+Bogen (reduziert) • STARR Codo soporte chimenea 87° reducido c. anclaje • STARR Baca destek dirseği 87° w. ankraj (azaltılmış) • STARR Καμπύλη στερέωσης 87° (συστολική)

Ø	Code Código	Kod Κωδ.	a (mm)	b (mm)	c (mm)	d (mm)	i
60/80	PBTU58		120	60	330	50	
80/100	PBTU8X		120	60	330	50	
80/110	PBTU81		120	60	330	50	
110/125	PBTU12		205	145	700	50	
125/160	PBTU26		185	125	700	50	
-	-		-	-	-	-	
-	-		-	-	-	-	

Please, contact technical department • Bitte wenden Sie sich an unsere technische Abteilung • Por favor, contacte nuestro departamento técnico • Lütfen teknik departmanla iletişime geçin • Επικοινωνήστε με το τεχνικό τμήμα

# RIGID GAS FLUE SYSTEM

STARRES ABGASSYSTEM

SISTEMA DE EVACUACIÓN PARA EL INTERIOR - RÍGIDO

SERT GAZ BACA SİSTEMİ STARR

ΑΚΑΜΠΤΟ ΣΥΣΤΗΜΑ ΚΑΠΝΟΔΟΧΟΥ

**Ø60 – 315 mm**

**STARR**

PPH – black

PPH – schwarz



PPH – negro

PPH – siyah

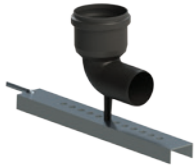
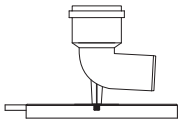

PPH – μαύρο

STARR

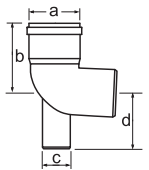

**STARR Chimney support elbow 87° w. a thorn and anchoring (reduced)**  
 STARR Bogen 87° reduziert m. Auflage • STARR Codo soporte 87° reducido c. anclaje • STARR Baca destek dirseği 87° w. diken ve ankraj (azaltılmış) • STARR Καμπύλη στερέωσης 87° ακίδας με αγκύρωση (συστολική)

		Ø	Code Código	Kod Κωδ.	a (mm)	b (mm)	c (mm)	d (mm)	
		60/80	PBTUB58		-	-	-	-	
		-	-		-	-	-	-	
		-	-		-	-	-	-	
		-	-		-	-	-	-	
		-	-		-	-	-	-	

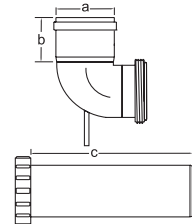

**STARR Chimney support elbow 87°**  
 STARR Stütztulpe m. Auflage+Bogen • STARR Codo soporte chimenea 87° c. apoyo • STARR Baca destek dirseği 87° • STARR Καμπύλη στερέωσης 87° με υποστήριξη

		Ø	Code Código	Kod Κωδ.	a (mm)	b (mm)	c (mm)	d (mm)	
		60 (60)	PBTUS5		60	110	56	120	
		80 (60)	PBTUS8		80	115	56	130	
		110 (80)	PBTUS1		111	130	77	150	
		125 (110)	PBTUS2		126	135	105	175	
		-	-		-	-	-	-	
		-	-		-	-	-	-	

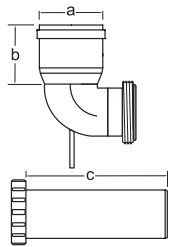

**STARR Elbow 87° for lining**  
 STARR Basisbogen 87° m. Schraubv. und Anschlussrohr (2-teilig) • STARR Codo base 87° c. tubo conex. (2 piezas) • STARR Dirsek 87° astar için • STARR Καμπύλη στερέωσης 87° με προέκταση

		Ø	Code Código	Kod Κωδ.	a (mm)	b (mm)	c (mm)	d (mm)	
		60	PBEB05		61	65	500	-	
		80	PBEB08		81	62	500	-	
		110	PBEB01		-	-	-	-	
		125	PBEB02		-	-	-	-	
		160	PBEB06		-	-	-	-	
		-	-		-	-	-	-	

**STARR Elbow 87° for lining, reduced**  
 STARR Basisbogen 87° reduziert m. Schraubv. u. Anschlussrohr (2-teilig) • STARR Codo base 87° reducido c. tubo conex. (2 piezas) • STARR Dirsek 87° astar için, azaltılmış • STARR Καμπύλη στερέωσης 87° με προέκταση (συστολική)

		Ø	Code Código	Kod Κωδ.	a (mm)	b (mm)	c (mm)	d (mm)	
		60/80	PBEB58		81	55	500	-	
		-	-		-	-	-	-	
		-	-		-	-	-	-	
		-	-		-	-	-	-	
		-	-		-	-	-	-	
		-	-		-	-	-	-	

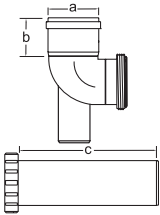
**STARR Elbow 87° for lining with support**  
 STARR Basisbogen 87° m. Abstützung, Schraubv. u. Anschlussrohr (2-teilig) • STARR Codo base 87° c. apoyo y tubo conex. (2 piezas) • STARR Dirsek 87° destekli astar için • STARR Καμπύλη στερέωσης 87° με προέκταση και υποστήριξη

		Ø	Code Código	Kod Κωδ.	a (mm)	b (mm)	c (mm)	d (mm)	
		60 (60)	PBES05		60	63	480	-	
		80 (80)	PBES08		81	65	480	-	
		110 (80)	PBES01		111	65	480	-	
		125 (110)	PBES02		126	70	480	-	
		160 (110)	PBES06		-	-	-	-	
		-	-		-	-	-	-	

 Please, contact technical department • Bitte wenden Sie sich an unsere technische Abteilung • Por favor, contacte nuestro departamento técnico • Lütfen teknik departmanla iletişime geçin • Επικοινωνήστε με το τεχνικό τμήμα

**Δεν κατασκευάσαμε ένα νέο σύστημα καπνοδόχου, το βελτιώσαμε !**

# RIGID GAS FLUE SYSTEM

STARRES ABGASSYSTEM

SISTEMA DE EVACUACIÓN PARA EL INTERIOR - RÍGIDO

SERT GAZ BACA SİSTEMİ STARR

ΑΚΑΜΠΤΟ ΣΥΣΤΗΜΑ ΚΑΠΝΟΔΟΧΟΥ

**Ø60 – 315 mm**

**STARR**

**PPH – black**

PPH – schwarz

PPH – negro

PPH – siyah

PPH – μαύρο

STARR

**STARR Elbow 87° for lining with support, reduced**  
 STARR Basisbogen 87° reduziert m. Abstützung, Schraubv. u. Anschlussrohr (2-teilig) • STARR Codo base 87° reducido c. apoyo y tubo conex. (2 piezas) • STARR Dirsek 87°destekli astar için, azaltılmış • STARR Καμπύλη στερέωσης 87° με προέκταση και υποστήριξη (συστολική)

Ø	Code Código	Kod Κωδ.	a (mm)	b (mm)	c (mm)	d (mm)	i
60/80 (60)	PBES58		-	-	-	-	
-	-		-	-	-	-	
-	-		-	-	-	-	
-	-		-	-	-	-	
-	-		-	-	-	-	
-	-		-	-	-	-	

**STARR Measuring piece**  
 STARR Messstück • STARR Tramo tm/muestras • STARR Ölçüm parçası • STARR Εξάρτημα με σημείο μέτρησης

Ø	Code Código	Kod Κωδ.	a (mm)	b (mm)	c (mm)	d (mm)	i
60	PBMS05		61	55	105	95	
80	PBMS08		81	62	110	85	
100	PBMS0X		101	63	105	83	
110	PBMS01		111	73	105	83	
125	PBMS02		127	75	105	83	
160	PBMS06		162	85	100	83	
200	PBMS00		203	150	160	145	
250	PBMS0V		254	260	↵	↵	
315	PBMS03		319	290	↵	↵	

**STARR Condensation trap**  
 STARR Kondensatfalle waagrecht/senkrecht • STARR Descarga condensados • STARR Yoğuşma karanı • STARR Παγίδα συμπυκνωμάτων

Ø	Code Código	Kod Κωδ.	a (mm)	b (mm)	c (mm)	d (mm)	i
60	PBKF05		61	55	117	95	<b>Installation in horizontal and vertical direction</b> Für horizontale und vertikale Installation Para instalación horizontal y vertical Yatay ve dikey yönde kurulum Για οριζόντια ή κάθετη τοποθέτηση
80	PBKF08		81	62	110	85	
100	PBKF0X		101	63	105	85	
110	PBKF01		111	73	105	85	
125	PBKF02		127	75	116	95	
160	PBKF06		162	85	120	95	
200	PBKF00		203	150	150	160	
250	PBKF0V		254	260	↵	↵	
315	PBKF03		319	290	↵	↵	

**STARR Condensation trap with test plug**  
 STARR Kondensatfalle m. MÖ • STARR Desc./cond. con tm/muestras • STARR Test tapalı yoğuşma karanı • STARR Παγίδα συμπυκνωμάτων με σημείο μέτρησης

Ø	Code Código	Kod Κωδ.	a (mm)	b (mm)	c (mm)	d (mm)	i
60	PBKFM5		61	55	117	95	<b>Installation in horizontal and vertical direction</b> Für horizontale und vertikale Installation Para instalación horizontal y vertical Yatay ve dikey yönde kurulum Για οριζόντια ή κάθετη τοποθέτηση
80	PBKFM8		81	62	110	85	
100	PBKFMX		101	63	105	85	
110	PBKFM1		111	73	105	85	
125	PBKFM2		127	75	116	95	
160	PBKFM6		162	85	120	95	
200	PBKFM0		203	150	150	160	
250	PBKFMV		254	260	↵	↵	
315	PBKFM3		319	290	↵	↵	

⌋ Please, contact technical department • Bitte wenden Sie sich an unsere technische Abteilung • Por favor, contacte nuestro departamento técnico • Lütfen teknik departmanla iletişime geçin • Επικοινωνήστε με το τεχνικό τμήμα

# RIGID GAS FLUE SYSTEM

STARRES ABGASSYSTEM

SISTEMA DE EVACUACIÓN PARA EL INTERIOR - RÍGIDO

SERT GAZ BACA SİSTEMİ STARR

ΑΚΑΜΠΤΟ ΣΥΣΤΗΜΑ ΚΑΠΝΟΔΟΧΟΥ

**Ø60 – 315 mm**

**STARR**

**PPH – black**

PPH – schwarz

PPH – negro

PPH – siyah

PPH – μαύρο

STARR

## STARR Socket with drain

STARR Muffe m. Ablauf • STARR Tape desc./cond. • STARR Drenajlı Priz • STARR Αποστράγγιση με υποδοχή

Ø	Code Código	Kod Κωδ.	a (mm)	b (mm)	c (mm)	d (mm)	i
60	PBMA05		63	75	32	40	
80	PBMA08		68	85	32	40	
100	PBMA0X		63	70	32	40	
110	PBMA01		63	65	32	40	
125	PBMA02		75	70	32	40	
160	PBMA06		85	70	32	40	
200	PBMA00		150	150	32	40	
250	PBMA0V		)	)	)	)	
315	PBMA03		)	)	)	)	

## STARR Threaded connector

STARR Schraubverbindungsteil • STARR Empalme roscado • STARR Dişli konektör • STARR Σύνδεσμος με σπειρώμα

Ø	Code Código	Kod Κωδ.	a (mm)	b (mm)	c (mm)	d (mm)	i
60	PBSV05		61	55	90	-	
80	PBSV08		81	62	130	-	
100	PBSV0X		101	63	122	-	
110	PBSV01		111	73	145	-	
125	PBSV02		127	75	165	-	
160	PBSV06		162	85	170	-	
200	PBSV00		203	150	)	-	
250	PBSV0V		254	260	)	-	
315	PBSV03		319	290	)	-	

## STARR Socket with cap

STARR Muffe m. Deckel • STARR Manguito con tape • STARR Kapaklı soket • STARR Τάπα με υποδοχή

Ø	Code Código	Kod Κωδ.	a (mm)	b (mm)	c (mm)	d (mm)	i
60	PBEN05		61	55	20	-	
80	PBEN08		81	62	20	-	
100	PBEN0X		101	63	20	-	
110	PBEN01		111	73	20	-	
125	PBEN02		127	75	20	-	
160	PBEN06		162	85	20	-	
200	PBEN00		203	150	20	-	
250	PBEN0V		254	260	)	-	
315	PBEN03		319	290	)	-	

## STARR Double socket (for air supply)

STARR Doppelmuffe (für Luftzufuhr) • STARR Manguito doble (para suministro de aire) • STARR Çift soket (hava beslemesi için) • STARR Σύνδεσμος (αέρας καύσης)

Ø	Code Código	Kod Κωδ.	a (mm)	b (mm)	c (mm)	d (mm)	i
60	PBDM05		61	55	-	-	
80	PBDM08		81	62	-	-	
100	PBDM0X		101	63	-	-	
110	PBDM01		111	73	-	-	
125	PBDM02		127	75	-	-	
160	PBDM06		162	85	-	-	
200	PBDM00		203	150	-	-	
250	PBDM0V		254	260	-	-	
315	PBDM03		319	290	-	-	

# RIGID GAS FLUE SYSTEM

STARRES ABGASSYSTEM

SISTEMA DE EVACUACIÓN PARA EL INTERIOR - RÍGIDO

SERT GAZ BACA SİSTEMİ STARR

ΑΚΑΜΠΤΟ ΣΥΣΤΗΜΑ ΚΑΠΝΟΔΟΧΟΥ

**Ø60 – 315 mm**

**STARR**

PPH – black

PPH – schwarz

PPH – negro

PPH – siyah

PPH – μαύρο

STARR

## STARR Double socket (for combustion gases)

STARR Doppelmuffe (für Verbrennungsgase) • STARR Manguito doble (para gases combustión) • STARR Çift soket (yanma gazları için) • STARR Σύνδεσμος (καυσαέρια)

Ø	Code Código	Kod Κωδ.	a (mm)	b (mm)	c (mm)	d (mm)	i
60	PBDMK5		61	55	-	-	
80	PBDMK8		81	62	-	-	
100	PBDMKX		101	63	-	-	
110	PBDMK1		111	73	-	-	
125	PBDMK2		127	75	-	-	
160	PBDMK6		162	85	-	-	
200	PBDMK0		203	150	-	-	
250	PBDMKV		254	260	-	-	
315	PBDMK3		319	290	-	-	

## STARR Silencer

STARR Abgas-Schalldämpfer • STARR Tramo silenciador • STARR Susturucu • STARR Σιγαστήρας καυσαερίων

Ø	Code Código	Kod Κωδ.	a (mm)	b (mm)	c (mm)	d (mm)	i	
500 mm	60	PBSD55	61	110	140	430		
	80	PBSD58	81	125	160	430		
	100	PBSD5X	101	160	210	400		
	110	PBSD51	111	160	210	400		
	125	PBSD52	127	200	250	400		
	160	PBSD56	162	250	250	400		
	200	PBSD50	203	315	315	350		
	250	PBSD5V						
	1000 mm	60	PBSD15	61	110	140	930	
		80	PBSD18	81	125	160	930	
100		PBSD1X	101	160	210	900		
110		PBSD11	111	160	210	900		
125		PBSD12	127	200	250	900		
160		PBSD16	162	250	250	900		
200		PBSD10	203	315	315	850		
250	PBSD1V							

## ZUB Universal spacer sleeve

ZUB Abstandhalter • STARR Centrador universal • ZUB Evrensel ara parça kovani • ZUB Αποστάτης

Ø	Code Código	Kod Κωδ.	a (mm)	b	i
-	PPFR00		260	1	<p>Values in column "b" indicate the number of segments of the spacer sleeve for relevant</p> <p>In der Spalte b ist Segmentanzahl des Abstandhalter aufgelistet</p> <p>Los valores en la columna b indican los segmentos de espacio entre los centradores</p> <p>„b“ sütunundaki değerler, ilgili ara parça manşonunun segment sayısını gösterir</p> <p>Οι τιμές στη στήλη "b" υποδεικνύουν τον αριθμό των ελασμάτων για την ολοκλήρωση του αποστάτη</p>
60	PPFR05		260	3	
80	PPFR08		270	4	
100	PPFR01		285	5	
110					
125	PPFR02		292	6	
160	PPFR06		310	7	
200	PPFR0X		330	9	
250	PPFR0V		355	11	
315	PPFR03		387	15	
80	PPFRN8		270	1	<p>1 piece of sleeve</p> <p>1 Stück • 1 brazo • 1 ara parçası • 1 αποστάτης</p>

# RIGID GAS FLUE SYSTEM

STARRES ABGASSYSTEM

SISTEMA DE EVACUACIÓN PARA EL INTERIOR - RÍGIDO

SERT GAZ BACA SİSTEMİ STARR

ΑΚΑΜΠΤΟ ΣΥΣΤΗΜΑ ΚΑΠΝΟΔΟΧΟΥ

**Ø60 – 315 mm**

**STARR**

**PPH – black**

PPH – schwarz

PPH – negro

PPH – siyah

PPH – μαύρο

STARR

**STARR Plastic chimney top (complete)**  
STARR Kaminabschluss (komplett) • STARR Salida techo (completo) • STARR Plastik baca tepesi (komple) • STARR Πλαστικό κάλυμμα καπνοδόχου (πλήρες)

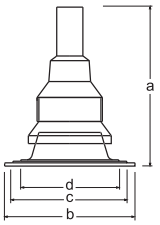
		Ø	Code Código	Kod Κωδ.	a (mm)	b (mm)	c (mm)	d (mm)	i
		60	PPSAS5	495	400	350	300	black schwarz negro siyah Μαύρο χρώμα	
80	PPSAS8	500	400	350	300				
100	PPSASX	500	400	350	300				
110	PPSAS1	500	400	350	300				
125	PPSAS2	500	400	350	300				
160	PPSAS6	500	400	350	300				
60	PPBAS5	495	400	350	300	brown braun marrón kahverengi Καφέ χρώμα			
80	PPBAS8	500	400	350	300				
100	PPBASX	500	400	350	300				
110	PPBAS1	500	400	350	300				
125	PPBAS2	500	400	350	300				
160	PPBAS6	500	400	350	300				

**STARR Stainless chimney top (complete)**  
STARR Kaminabschluss (komplett) • STARR Salida techo Inox (completa) • STARR Paslanmaz baca tepesi (komple) • STARR Κάλυμμα καπνοδόχου (πλήρες)

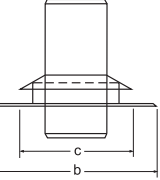
		Ø	Code Código	Kod Κωδ.	a (mm)	b (mm)	c (mm)	d (mm)	i
		200	ESTAV0	315	400	300	-	Stainless steel Edelstahl Acero inoxidable Paslanmaz çelik Ανοξείδωτος χάλυβας	
250	ESTAVV	315	400	300	-				
315	ESTAV3	315	400	300	-				
-	-	-	-	-	-				
-	-	-	-	-	-				
-	-	-	-	-	-				

**STARR Rain collar**  
STARR Wetterkragen • STARR Collarín antilluvia • STARR Yağmurluk • STARR Προστατευτικό βροχής

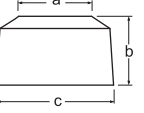
		Ø	Code Código	Kod Κωδ.	a (mm)	b (mm)	c (mm)	d (mm)	i
		60	PPWS05	61	100	120	-	black schwarz negro siyah Μαύρο χρώμα	
80	PPWS08	81	75	120	-				
100	PPWS0X	101	145	135	-				
110	PPWS01	111	135	135	-				
125	PPWS02	127	130	204	-				
160	PPWS06	162	100	204	-				
60	PPWB05	61	100	120	-	brown braun marrón kahverengi Καφέ χρώμα			
80	PPWB08	81	75	120	-				
100	PPWB0X	101	145	135	-				
110	PPWB01	111	135	135	-				
125	PPWB02	127	130	204	-				
160	PPWB06	162	100	204	-				

# RIGID GAS FLUE SYSTEM

STARRES ABGASSYSTEM

SISTEMA DE EVACUACIÓN PARA EL INTERIOR - RÍGIDO

SERT GAZ BACA SİSTEMİ STARR

ΑΚΑΜΠΤΟ ΣΥΣΤΗΜΑ ΚΑΠΝΟΔΟΧΟΥ

**Ø60 – 315 mm**

**STARR**

**PPH – black**

PPH – schwarz

PPH – negro

PPH – siyah

PPH – μαύρο

STARR

## STARR Tapered rain collar

STARR Wetterkragen f. Mantelrohr • STARR Collarín antilluvia cónico • STARR Konik yağmurluk • STARR Κωνικό προστατευτικό βροχής

Ø	Code Código	Kod Κωδ.	a (mm)	b (mm)	c (mm)	d (mm)	i
60	PPWS52		61	230	200	-	black schwarz negro siyah Μαύρο χρώμα
80	PPWS82		81	206	200	-	
100	PPWSX2		100	180	200	-	
110	PPWS12		110	170	200	-	
-	-		-	-	-	-	
60	PPWB52		61	230	200	-	brown braun marrón kahverengi Καφέ χρώμα
80	PPWB82		81	206	200	-	
100	PPWBX2		100	180	200	-	
110	PPWB12		110	170	200	-	
-	-		-	-	-	-	

## STARR Rain collar for end pipe (250 mm)

STARR Wetterkragen (250 mm) • STARR Collarín antilluvia (250 mm) • STARR Uç boru için yağmur bileziği (250 mm) • STARR Προστατευτικό βροχής για τον τελικό σωλήνα (250mm)

Ø	Code Código	Kod Κωδ.	a (mm)	b (mm)	c (mm)	d (mm)	i
60	PPWS5V		61	320	250	-	black schwarz negro siyah Μαύρο χρώμα
80	PPWS8V		81	310	250	-	
100	PPWSXV		101	300	250	-	
110	PPWS1V		111	290	250	-	
125	PPWS2V		127	250	250	-	
160	PPWS6V		162	230	250	-	
200	PPWS0V		203	200	250	-	
-	-		-	-	-	-	
-	-		-	-	-	-	
-	-		-	-	-	-	

## STARR Rain collar for end pipe (315 mm)

STARR Wetterkragen (315 mm) • STARR Collarín antilluvia (315 mm) • STARR Uç boru için yağmur bileziği (315 mm) • STARR Προστατευτικό βροχής για τον τελικό σωλήνα (315mm)

Ø	Code Código	Kod Κωδ.	a (mm)	b (mm)	c (mm)	d (mm)	i
60	PPWS53		61	320	315	-	black schwarz negro siyah Μαύρο χρώμα
80	PPWS83		81	310	315	-	
100	PPWSX3		101	300	315	-	
110	PPWS13		111	290	315	-	
125	PPWS23		127	250	315	-	
160	PPWS63		162	230	315	-	
200	PPWS03		203	200	315	-	
250	PPWSV3		254	200	315	-	
-	-		-	-	-	-	

## STARR End pipe without socket

STARR Mündungsrohr • STARR Tubo terminal M/M • STARR Soketsiz uç borusu • STARR Τελικός σωλήνας χωρίς υποδοχή (κεφάλι)

Ø	Code Código	Kod Κωδ.	a (mm)	b (mm)	c (mm)	d (mm)	i
60	PPRS55		495	-	-	-	black schwarz negro siyah Μαύρο χρώμα
80	PPRS58		500	-	-	-	
100	PPRS5X		500	-	-	-	
110	PPRS51		500	-	-	-	
125	PPRS52		500	-	-	-	
160	PPRS56		500	-	-	-	
200	PPRS50		600	-	-	-	
250	PPRS5V		700	-	-	-	
315	PPRS53		800	-	-	-	
-	-		-	-	-	-	

# RIGID GAS FLUE SYSTEM

STARRES ABGASSYSTEM

SISTEMA DE EVACUACIÓN PARA EL INTERIOR - RÍGIDO

SERT GAZ BACA SİSTEMİ STARR

ΑΚΑΜΠΤΟ ΣΥΣΤΗΜΑ ΚΑΠΝΟΔΟΧΟΥ

**Ø60 – 315 mm**

**STARR**

**PPH – black**

PPH – schwarz

PPH – negro

PPH – siyah

PPH – μαύρο

STARR

**STARR Extension for chimney head**  
STARR Kaminplattenverlängerung aus Kst. • STARR Extensión para salida techo • STARR Baca başlığı için uzatma • STARR Προέκταση πλάκας καπέλου καπνοδόχου

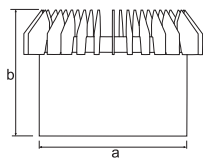
		Ø	Code Código	Kod Κωδ.	a (mm)	b (mm)	c (mm)	d (mm)	i
		60-175	PPKMS0		200	170	-	-	
60-175	PPKMBO		200	170	-	-		<b>brown</b> braun marrón kahverengi Μαύρο χρώμα	

**STARR Universal chimney flashing plate**  
STARR Kaminplatte universal • STARR Placa salida techo univ. • STARR Üniversal baca flashing plakası • STARR Πλάκα καπέλου καπνοδόχου

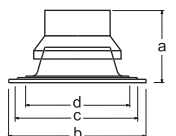
		Ø	Code Código	Kod Κωδ.	a (mm)	b (mm)	c (mm)	d (mm)	i
		univ. 60 - 175	PPKPU0		235	400	350	300	
univ. 60 - 175	PPKB00		235	400	350	300		<b>brown</b> braun marrón kahverengi Μαύρο χρώμα	

**STARR Stainless chimney flashing plate**  
STARR Kaminplatte Edelstahl • STARR Placa salida techo Inox • STARR Paslanmaz baca flashing plakası • STARR Πλάκα καπέλου καπνοδόχου (inox)

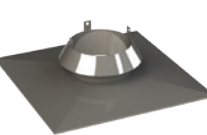
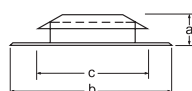
		Ø	Code Código	Kod Κωδ.	a (mm)	b (mm)	c (mm)	d (mm)	i
		200	IVEKPA20		105	400	300	-	
250	IVEKPA25		110	450	300	-			
315	IVEKPA31		-	515	300	-			
-	-		-	-	-	-	-		
-	-		-	-	-	-	-		

**STARR Y piece**  
STARR Hosenrohr • STARR Tubo horquilla • STARR Y παρça • STARR Εξάρτημα Y

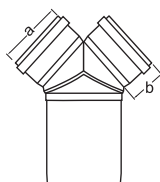
			Ø	Code Código	Kod Κωδ.	a (mm)	b (mm)	c (mm)	d (mm)	i
			500 mm	80/2x60	PBHR58		61	55	80	
100/2x60	PBHR5X			61	55	100	-			
100/2x80	PBHR8X			80	62	100	-			
110/2x60	PBHR51			60	55	110	-			
110/2x80	PBHR81			80	62	110	-			
125/2x60	PBHR52			61	55	125	-			
125/2x80	PBHR82			80	62	125	-			
1000 mm	125/2x110	PBHR12			111	73	125	-		
	160/2x60	PBHR56			61	55	160	-		
	160/2x80	PBHR86			80	62	160	-		
	160/2x110	PBHR16			111	73	160	-		
	160/2x125	PBHR26			126	75	160	-		
	200/2x60	PBHR50			61	55	200	-		
	200/2x80	PBHR80			80	62	200	-		
	200/2x110	PBHR10		111	73	200	-			
200/2x125	PBHR20		126	75	200	-				
200/2x160	PBHR60		162	85	200	-				

**Information for elements Ø250 and 315 are available upon request.** • Informationen zu den Elementen Ø250 und 315 auf Anfrage.

Información sobre elementos de Ø250 y 315 disponibles bajo demanda. • 250 ve 315 numaralı unsurlar için bilgiler talep üzerine temin edilebilir.

Πληροφορίες για εξαρτήματα Ø250 και 315 διατίθενται κατόπιν αιτήσεως.

# RIGID GAS FLUE SYSTEM

STARRES ABGASSYSTEM

SISTEMA DE EVACUACIÓN PARA EL INTERIOR - RÍGIDO

SERT GAZ BACA SİSTEMİ STARR

ΑΚΑΜΠΤΟ ΣΥΣΤΗΜΑ ΚΑΠΝΟΔΟΧΟΥ

**Ø60 – 315 mm**

**STARR**

PPH – black

PPH – schwarz

PPH – negro

PPH – siyah

PPH – μαύρο

STARR

## STARR Boiler adapter centric

STARR Kesselanschluss konzentrisch • STARR Adapt. caldera céntrico • STARR Kazan adaptörü merkezli • STARR Συστολή λέβητα - ομοκεντρική

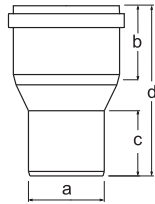

Ø	Code Código	Kod Κωδ.	a (mm)	b (mm)	c (mm)	d (mm)	ⓘ
60	PBKA51		50	63	63	140	
60	PBKA52		63	63	65	140	
60	PBKA53		70	63	70	145	
60	PBKA54		75	63	70	145	
60	PBKA55		80	63	80	165	
80	PBKA01		60	68	65	150	
80	PBKA02		63	68	55	145	
80	PBKA03		70	68	70	145	
80	PBKA04		75	68	45	115	
80	PBKA23		100	68	100	183	
80	PBKA24		110	68	100	185	
80	PBKA81		125	68	100	185	
100	PBKA0X		60	63	65	168	
100	PBKA1X		63	63	65	165	
100	PBKA2X		70	63	70	163	
100	PBKA3X		75	63	45	115	
100	PBKA4X		80	63	57	140	
100	PBKA5X		110	63	70	145	
100	PBKA6X		125	63	100	188	
100	PBKA7X		130	63	65	158	
100	PBKA8X		150	63	90	203	
100	PBKA9X		153	63	90	205	
110	PBKA41		60	63	65	140	
110	PBKA42		63	63	65	140	
110	PBKA43		70	63	70	140	
110	PBKA07		75	63	45	160	
110	PBKA08		80	63	57	152	
110	PBKA09		100	63	70	145	
110	PBKA26		125	63	100	175	
110	PBKA10		130	63	65	150	
110	PBKA11		150	63	90	200	
110	PBKA25		153	63	100	200	
125	PBKA06		80	75	80	200	
125	PBKA12		100	75	70	185	
125	PBKA13		110	75	86	185	
125	PBKA14		130	75	65	75	
125	PBKA15		150	75	90	185	
125	PBKA16		153	75	90	200	
125	PBKA38		160	75	100	200	
125	PBKA39		200	75	150	240	
160	PBKA61		80	85	70	200	
160	PBKA17		100	85	95	260	
160	PBKA18		110	85	95	250	
160	PBKA19		125	85	90	240	
160	PBKA20		130	85	65	220	
160	PBKA21		150	85	90	175	
160	PBKA22		153	85	90	175	
160	PBKA62		180	85	100	195	
160	PBKA63		200	85	150	250	
200	PBKA32		100	150	100	300	
200	PBKA30		110	150	100	300	
200	PBKA35		125	150	100	290	
200	PBKA31		130	150	65	245	
200	PBKA33		150	150	90	260	
200	PBKA34		153	150	90	300	
200	PBKA27		160	150	100	290	
200	PBKA28		180	150	100	280	
200	PBKA36		225	150	150	310	
200	PBKA37		250	150	150	330	

**Information for elements Ø250 and 315 are available upon request.**

Informationen zu den Elementen Ø250 und 315 auf Anfrage.

Información sobre los elementos Ø250 y 315 disponibles bajo demanda.

250 ve 315 numaralı unsurlar için bilgiler talep üzerine temin edilebilir.

Πληροφορίες για εξαρτήματα Ø250 και 315 διατίθενται κατόπιν αιτήσεως.

# RIGID GAS FLUE SYSTEM

STARRES ABGASSYSTEM

SISTEMA DE EVACUACIÓN PARA EL INTERIOR - RÍGIDO

SERT GAZ BACA SİSTEMİ STARR

ΑΚΑΜΠΤΟ ΣΥΣΤΗΜΑ ΚΑΠΝΟΔΟΧΟΥ

**Ø60 – 315 mm**

**STARR**

**PPH – black**

PPH – schwarz

PPH – negro

PPH – siyah

PPH – μαύρο

## STARR Boiler adapter eccentric

STARR Kesselanschluss exzentrisch • STARR Adapt. caldera excéntrico • STARR Kazan adaptörü eksantrik • STARR Συστολή λέβητα - έκκεντρη

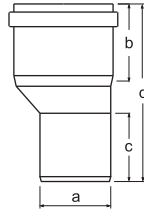

Ø	Code Código	Kod Κωδ.	a (mm)	b (mm)	c (mm)	d (mm)	ⓘ
60	PBKX51		50	63	63	140	
60	PBKX52		63	63	65	140	
60	PBKX53		70	63	70	145	
60	PBKX54		75	63	70	145	
60	PBKX55		80	63	80	165	
80	PBKX01		60	68	70	150	
80	PBKX02		63	68	55	145	
80	PBKX03		70	68	70	145	
80	PBKX04		75	68	100	187	
80	PBKX23		100	68	100	198	
80	PBKX24		110	68	100	255	
80	PBKX81		125	68	100	185	
100	PBKX0X		60	63	65	188	
100	PBKX1X		63	63	65	185	
100	PBKX2X		70	63	70	175	
100	PBKX3X		75	63	45	155	
100	PBKX4X		80	63	57	160	
100	PBKX5X		110	63	70	145	
100	PBKX6X		125	63	100	170	
100	PBKX7X		130	63	65	135	
100	PBKX8X		150	63	90	155	
100	PBKX9X		153	63	90	155	
110	PBKX41		60	63	65	160	
110	PBKX42		63	63	65	160	
110	PBKX43		70	63	70	155	
110	PBKX07		75	63	45	125	
110	PBKX08		80	63	57	145	
110	PBKX09		100	63	70	145	
110	PBKX26		125	63	100	165	
110	PBKX10		130	63	65	130	
110	PBKX11		150	63	90	155	
110	PBKX25		153	63	100	165	
125	PBKX06		80	75	80	155	
125	PBKX12		100	75	70	145	
125	PBKX13		110	75	85	160	
125	PBKX14		130	75	65	140	
125	PBKX15		150	75	90	165	
125	PBKX16		153	75	90	165	
125	PBKX38		160	75	100	175	
125	PBKX39		200	75	150	225	
160	PBKX61		80	85	70	155	
160	PBKX17		100	85	95	180	
160	PBKX18		110	85	95	180	
160	PBKX19		125	85	90	180	
160	PBKX20		130	85	65	150	
160	PBKX21		150	85	90	175	
160	PBKX22		153	85	90	175	
160	PBKX62		180	85	100	185	
160	PBKX63		200	85	150	235	
200	PBKX32		100	150	100	250	
200	PBKX30		110	150	100	250	
200	PBKX35		125	150	100	250	
200	PBKX31		130	150	65	215	
200	PBKX33		150	150	90	240	
200	PBKX34		153	150	90	240	
200	PBKX27		160	150	100	250	
200	PBKX28		180	150	100	250	
200	PBKX36		225	150	150	300	
200	PBKX37		250	150	150	300	

**Information for elements Ø250 and 315 are available upon request.**

Informationen zu den Elementen Ø250 und 315 auf Anfrage.

Información sobre los elementos Ø250 y 315 disponibles bajo demanda.

250 ve 315 numaralı unsurlar için bilgiler talep üzerine temin edilebilir.

Πληροφορίες για εξαρτήματα Ø250 και 315 διατίθενται κατόπιν αιτήσεως.

STARR

# RIGID GAS FLUE SYSTEM

STARRES ABGASSYSTEM

SISTEMA DE EVACUACIÓN PARA EL INTERIOR - RÍGIDO

SERT GAZ BACA SİSTEMİ STARR

ΑΚΑΜΠΤΟ ΣΥΣΤΗΜΑ ΚΑΠΝΟΔΟΧΟΥ

**Ø60 – 315 mm**

**STARR**

**PPH – black**

PPH – schwarz

PPH – negro

PPH – siyah

PPH – μαύρο

STARR

## STARR Boiler adapter w. test plug

STARR Kesselanschluss m. MÖ • STARR Adapt. caldera con tm/muestras • STARR Kazan adaptörü ve test fişi • STARR Συστολή λέβητα με σημείο μέτρησης

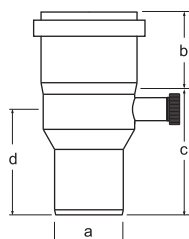

Ø	Code Código	Kod Κωδ.	a (mm)	b (mm)	c (mm)	d (mm)	ⓘ
60	PBKM51		50	63	92	77	
60	PBKM52		63	63	92	77	
60	PBKM53		70	63	97	82	
60	PBKM54		75	63	97	82	
60	PBKM55		80	63	117	102	
80	PBKM01		60	68	97	82	
80	PBKM02		63	68	95	77	
80	PBKM03		70	68	95	77	
80	PBKM04		75	68	65	47	
80	PBKM23		100	68	130	115	
80	PBKM24		110	68	135	117	
80	PBKM028		125	68	135	117	
100	PBKM0X		60	63	105	95	
100	PBKM1X		63	63	105	95	
100	PBKM2X		70	63	105	90	
100	PBKM3X		75	63	107	97	
100	PBKM4X		80	63	102	92	
100	PBKM5X		110	63	97	82	
100	PBKM6X		125	63	115	100	
100	PBKM7X		130	63	102	87	
100	PBKM8X		150	63	115	105	
100	PBKM9X		153	63	115	105	
110	PBKM051		60	63	105	95	
110	PBKM631		63	63	105	95	
110	PBKM43		70	63	105	90	
110	PBKM07		75	63	112	97	
110	PBKM08		80	63	110	92	
110	PBKM09		100	63	97	82	
110	PBKM26		125	63	115	100	
110	PBKM10		130	63	102	87	
110	PBKM11		150	63	120	105	
110	PBKM25		153	63	120	105	
125	PBKM06		80	75	140	125	
125	PBKM12		100	75	130	110	
125	PBKM13		110	75	130	110	
125	PBKM14		130	75	130	110	
125	PBKM15		150	75	130	110	
125	PBKM16		153	75	140	125	
125	PBKM062		160	75	160	145	
125	PBKM002		200	75	190	185	
160	PBKM61		80	85	190	175	
160	PBKM17		100	85	190	175	
160	PBKM18		110	85	180	165	
160	PBKM19		125	85	175	155	
160	PBKM20		130	85	95	80	
160	PBKM21		150	85	120	105	
160	PBKM22		153	85	120	105	
160	PBKM186		180	85	120	105	
160	PBKM006		200	85	190	175	
200	PBKM100		100	150	250	235	
200	PBKM30		110	150	250	235	
200	PBKM35		125	150	240	225	
200	PBKM130		130	150	190	175	
200	PBKM150		150	150	180	165	
200	PBKM530		153	150	170	150	
200	PBKM27		160	150	180	160	
200	PBKM28		180	150	180	160	
200	PBKM220		225	150	210	200	
200	PBKM250		250	150	210	200	

### Information for elements Ø250 and 315 are available upon request.

Informationen zu den Elementen Ø250 und 315 auf Anfrage.

Información sobre los elementos Ø250 y 315 disponibles bajo demanda.

250 ve 315 numaralı unsurlar için bilgiler talep üzerine temin edilebilir.

Πληροφορίες για εξαρτήματα Ø250 και 315 διατίθενται κατόπιν αιτήσεως.

# RIGID GAS FLUE SYSTEM

STARRES ABGASSYSTEM

SISTEMA DE EVACUACIÓN PARA EL INTERIOR - RÍGIDO

SERT GAZ BACA SİSTEMİ STARR

ΑΚΑΜΠΤΟ ΣΥΣΤΗΜΑ ΚΑΠΝΟΔΟΧΟΥ

**Ø60 – 315 mm**

**STARR**

**PPH – black**

PPH – schwarz

PPH – negro

PPH – siyah

PPH – μαύρο

**STARR**

## STARR Boiler Adapter-Tee with test plug (reduced)

STARR Umlenk-T m. MÖ als KA (reduziert) • STARR Te-Adapt. cald. reducido con tm/muestras • STARR Kazan Adaptörü-Tee, test tapalı (azaltılmış) • STARR Ταφ με θυρίδα επιθεώρησης και σημείο μέτρησης (συστολικό)

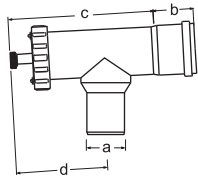

Ø	Code Código	Kod Κωδ.	a (mm)	b (mm)	c (mm)	d (mm)	i
60	PBKT51		50	63	205	142	
60	PBKT52		63	63	205	142	
60	PBKT53		70	63	205	142	
60	PBKT54		75	63	205	142	
60	PBKT55		80	63	205	142	
80	PBKT01		60	68	245	161	
80	PBKT02		63	68	245	161	
80	PBKT03		70	68	245	161	
80	PBKT04		75	68	245	161	
80	PBKT23		100	68	245	161	
80	PBKT24		110	68	245	161	
80	PBKT028		125	68	245	161	
100	PBKT0X		60	63	272	195	
100	PBKT1X		63	63	272	195	
100	PBKT2X		70	63	272	195	
100	PBKT3X		75	63	272	195	
100	PBKT4X		80	63	272	195	
100	PBKT5X		110	63	272	195	
100	PBKT6X		125	63	272	195	
100	PBKT7X		130	63	272	195	
100	PBKT8X		150	63	272	195	
100	PBKT9X		153	63	272	195	
110	PBKT051		60	63	225	158	
110	PBKT631		63	63	225	158	
110	PBKT43		70	63	225	158	
110	PBKT07		75	63	225	158	
110	PBKT08		80	63	225	158	
110	PBKT09		100	63	225	158	
110	PBKT26		125	63	225	158	
110	PBKT10		130	63	225	158	
110	PBKT11		150	63	225	158	
110	PBKT25		153	63	225	158	
125	PBKT06		80	75	315	225	
125	PBKT12		100	75	315	225	
125	PBKT13		110	75	315	225	
125	PBKT14		130	75	315	225	
125	PBKT15		150	75	315	225	
125	PBKT16		153	75	315	225	
125	PBKT062		160	75	315	225	
125	PBKT002		200	75	315	225	
160	PBKT61		80	85	360	215	
160	PBKT17		100	85	360	215	
160	PBKT18		110	85	360	215	
160	PBKT19		125	85	360	215	
160	PBKT20		130	85	360	215	
160	PBKT21		150	85	360	215	
160	PBKT22		153	85	360	215	
160	PBKT186		180	85	360	215	
160	PBKT006		200	85	360	215	
200	PBKT100		100	150	470	280	
200	PBKT30		110	150	470	280	
200	PBKT35		125	150	470	280	
200	PBKT130		130	150	470	280	
200	PBKT150		150	150	470	280	
200	PBKT530		153	150	470	280	
200	PBKT27		160	150	470	280	
200	PBKT28		180	150	470	280	
200	PBKT220		225	150	470	280	
200	PBKT250		250	150	470	280	

**Information for elements Ø250 and 315 are available upon request.**

Informationen zu den Elementen Ø250 und 315 auf Anfrage.

Información sobre los elementos Ø250 y 315 disponibles bajo demanda.

250 ve 315 numaralı unsurlar için bilgiler talep üzerine temin edilebilir.

Πληροφορίες για εξαρτήματα Ø250 και 315 διατίθενται κατόπιν αιτήσεως.

**Δεν κατασκευάσαμε ένα νέο σύστημα καπνοδόχου, το βελτιώσαμε !**

# FLEXIBLE GAS FLUE SYSTEM

**FLEX**  
PPH

FLEXIBLES ABGASSYSTEM

SISTEMA DE EVACUACIÓN PARA EL INTERIOR - FLEXIBLE

ESNEK GAZ BACA SİSTEMİ

ΕΥΚΑΜΠΤΟ ΣΥΣΤΗΜΑ ΚΑΠΝΟΔΟΧΟΥ

**Ø60 – 200 mm**

**FLEX**

1	PPSAS8
2	PPFR60
3	PPRF18
4	ZUHF08
5	PPTXF8
6	TTAD01
7	ZUBF08
8	PPSTF8
9	ZUBL08
10	PBRM08
11	PBRTD8
12	PBRTA8
13	PBTM98
14	PBKA01

FLEX			
Ø (mm)	Inner dimension of socket Innenmass des Rohres Dimensión interior del tubo Soketin iç boyutu Εσωτερική διατομή υποδοχής (mm)	Wall thickness Wandstärke Espesor de pared Duvar kalınlığı Πάχος τοιχώματος (mm)	Outer dimension of socket Ausßenmass der Muffe Dimensión exterior del manguito Soketin dış boyutu Εξωτερική διατομή υποδοχής (mm)
60	60	1	72
80	80	1	92
110	100	1	112
125	125	1	137
160	153	1	175
200	178	1	200

**When assembling horizontal piping, it is necessary to create a slope towards the boiler at minimum of 3°.**

Gefälle schaffen waagerechte Verbindungsleitung muss zum Kessel immer ein Gefälle von mindestens 3° haben.

Al montar las tuberías horizontales, es necesario crear una pendiente hacia la caldera de un mínimo de 3°.

Yatay boru tesisatını monte ederken, kazana doğru en az 3°'lik bir eğim oluşturmak gerekir.

Κατά την εγκατάσταση οριζόντιων σωληνώσεων, πρέπει να υπάρχει κλίση προς τον λέβητα τουλάχιστον 3°.

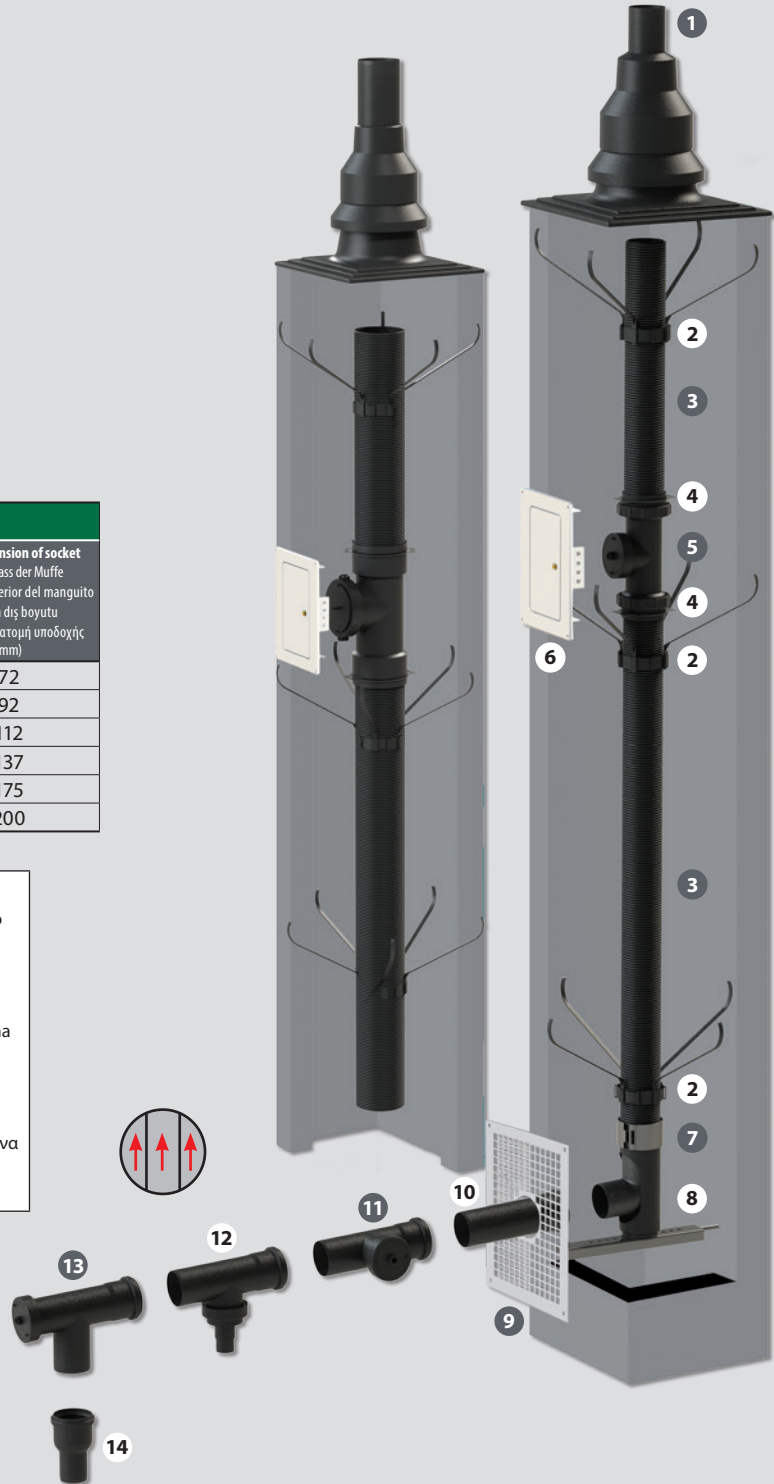

# FLEXIBLE GAS FLUE SYSTEM

**FLEX**  
PPH

FLEXIBLES ABGASSYSTEM

SISTEMA DE EVACUACIÓN PARA EL INTERIOR - FLEXIBLE

ESNEK GAZ BACA SİSTEMİ

ΕΥΚΑΜΠΤΟ ΣΥΣΤΗΜΑ ΚΑΠΝΟΔΟΧΟΥ

**Ø60 – 200 mm**

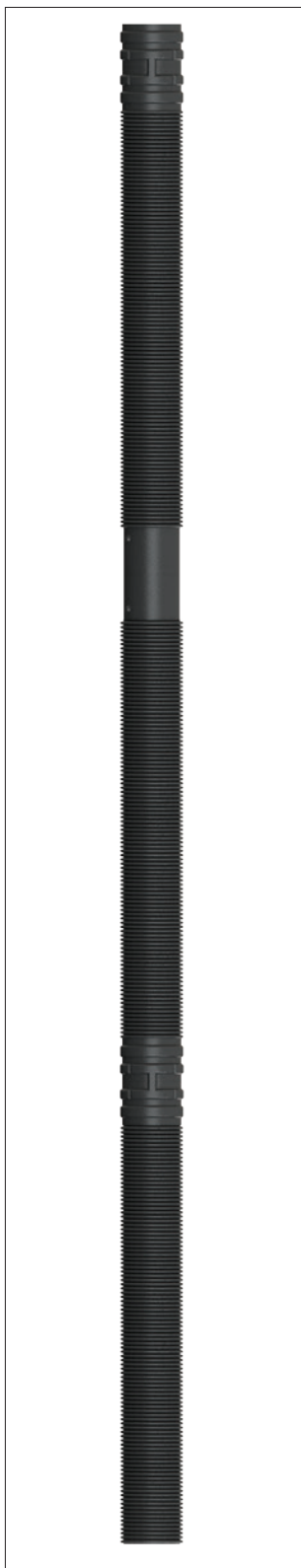

### Ways of cutting flexible hose.

Möglichkeiten zum Schneiden von flexiblen Rohren.

Formas de cortar el tubo flexible.

Esnek hortum kesme yolları.

Τρόποι κοπής εύκαμπτων σωλήνων.



### Insert FLEX seal.

FLEX-Dichtung einsetzen.

Insertar la junta FLEX.

FLEX contayı yerleştirin.

Εισάγετε τον δακτύλιο FLEX



### Connection of flexible hoses.

Verbindung von flexiblen Rohren.

Conexión de tubos flexibles.

Esnek hortumların bağlantısı.

Σύνδεση εύκαμπτων σωλήνων.

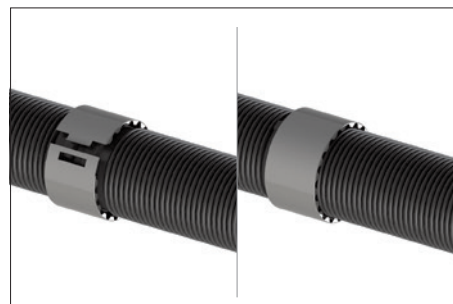

### Securing the connection of flexible hoses.

Absicherung der Verbindung von flexiblen Rohren.

Asegurar la conexión de los tubos flexibles.

Esnek hortumların bağlantısının sabitlenmesi.

Ασφάλιση σύνδεσης εύκαμπτων σωλήνων.

**FLEX**

# FLEXIBLE GAS FLUE SYSTEM

**FLEX**  
PPH

FLEXIBLES ABGASSYSTEM

SISTEMA DE EVACUACIÓN PARA EL INTERIOR - FLEXIBLE

ESNEK GAZ BACA SÍSTEMI

ΕΥΚΑΜΠΤΟ ΣΥΣΤΗΜΑ ΚΑΠΝΟΔΟΧΟΥ

**Ø60 – 200 mm**

FLEX

## FLEX Flexible hose

FLEX Flexrohr-Rolle • FLEX Tubo flexible (rollo) • FLEX Esnek hortum • FLEX Εύκαμπτος σωλήνας

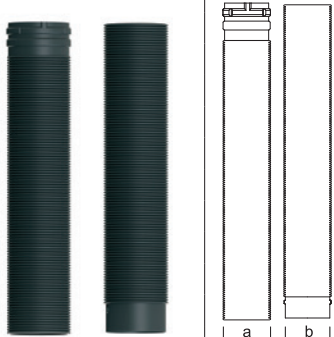
	Ø	Code Código	Kod Κωδ.	a (mm)	b (mm)	c (mm)	d (mm)	i	
	15 m - RI.	60	PPRF15	72	60				
	30 m - RI.	60	PPRF35	72	60				
	50 m - RI.	60	PPRF55	72	60				
	15 m - RI.	80	PPRF18	92	80				
	30 m - RI.	80	PPRF38	92	80				
	50 m - RI.	80	PPRF58	92	80				
	15 m - RI.	100	PPRF1X	112	100				
	30 m - RI.	100	PPRF3X	112	100				
	50 m - RI.	100	PPRF5X	112	100				
	15 m - RI.	125	PPRF12	137	125				
	30 m - RI.	125	PPRF32	137	125				
	50 m - RI.	125	PPRF52	137	125				
	25 m - RI.	175/160	PURF75	175	153				Flexible hose - roll Flexible Rohrrolle - Rollo tubo flexible - Esnek hortum - rulo - roló
	30 m - RI.	200/200	PURF00	200	178				

## FLEX Flexible hose in box (50 m)

FLEX-Rohr im Karton (50 m) • FLEX Tubo flexible en caja (50 m) • FLEX Kutu içinde esnek hortum (50 m) • Εύκαμπτος σωλήνας σε συσκευασία (50m)

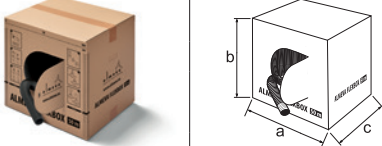
	Ø	Code Código	Kod Κωδ.	a (mm)	b (mm)	c (mm)	d (mm)	i
	80	PPRFB8		1020	1034	820	-	<b>Packing: 50m</b> Verpackung: 50m Empaquetado: 50m Kutu içinde (50 m) Συσκευασία: 50m
	-	-	-	-	-	-	-	
	-	-	-	-	-	-	-	
	-	-	-	-	-	-	-	
	-	-	-	-	-	-	-	

## FLEX Adapter starr/flex

FLEX Adapter starr/flex • FLEX Adaptador rígido/flex • FLEX Adaptör starr/flex • FLEX Προσαρμογέας starr/flex

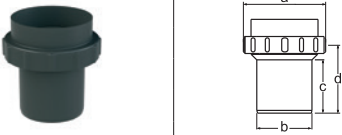
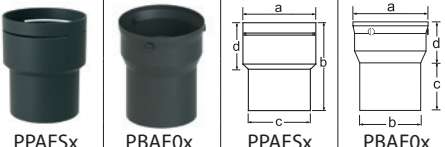
	Ø	Code Código	Kod Κωδ.	a (mm)	b (mm)	c (mm)	d (mm)	i
	60	PPAES5		120	60	73	50	
	80	PPAES8		120	80	65	80	
	-	-	-	-	-	-	-	
	-	-	-	-	-	-	-	
	100	PPAESX		120	160	100	68	
	110/100	PPAES1		120	170	111	68	
	125	PPAES2		141	170	120	90	
	160/175	PBAE06		195	160	125	105	
	180/200	PBAE00		212	200	145	70	

## FLEX Adapter flex/starr

FLEX Adapter flex/starr • FLEX Adaptador flex/rígido • FLEX Adaptör flex/starr • FLEX Προσαρμογέας flex/starr

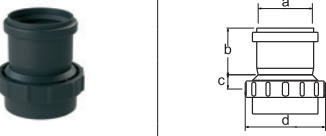
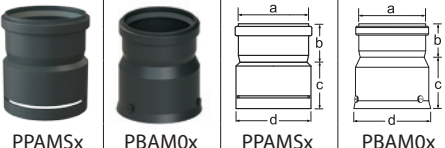
	Ø	Code Código	Kod Κωδ.	a (mm)	b (mm)	c (mm)	d (mm)	i
	60	PPAMS5		61	68	15	75	
	80	PPAMS8		81	68	20	120	
	-	-	-	-	-	-	-	
	-	-	-	-	-	-	-	
	100	PPAMSX		102	68	68	120	
	110/100	PPAMS1		111	66	68	120	
	125	PPAMS2		132	73	90	141	
	160/175	PBAM06		162	110	105	195	
	180/200	PBAM00		210	105	70	212	

# FLEXIBLE GAS FLUE SYSTEM

**FLEX**  
PPH



FLEXIBLES ABGASSYSTEM





SISTEMA DE EVACUACIÓN PARA EL INTERIOR - FLEXIBLE

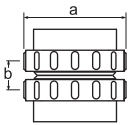

ESNEK GAZ BACA SÍSTEMI

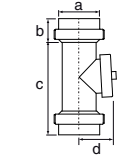

ΕΥΚΑΜΠΤΟ ΣΥΣΤΗΜΑ ΚΑΠΝΟΔΟΧΟΥ

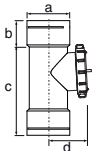
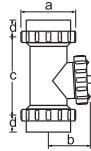
**Ø60 – 200 mm**

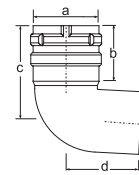
<b>FLEX Connector flex/flex</b> FLEX Flexkupplung • FLEX Empalme flex/flex • FLEX Konnektör flex/flex • FLEX Σύνδεσμος flex/flex									
		Ø	Code Código	Kod Κωδ.	a (mm)	b (mm)	c (mm)	d (mm)	
		160	PPKU06	210	70	-	-	-	
200	PPKU00	240	55	-	-	-	-	-	
-	-	-	-	-	-	-	-	-	
-	-	-	-	-	-	-	-	-	
-	-	-	-	-	-	-	-	-	

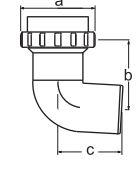
<b>FLEX Inspection-Tee flex/flex</b> FLEX Revisions-T flex/flex • FLEX Te-Inspección flex/flex • FLEX Revizyonları-T flex/flex • FLEX Ταφ με θυρίδα επιθεώρησης									
		Ø	Code Código	Kod Κωδ.	a (mm)	b (mm)	c (mm)	d (mm)	
		60	PPTXF5	85	27	135	80	-	
80	PPTXF8	120	40	280	85	-	-	-	
-	-	-	-	-	-	-	-	-	
-	-	-	-	-	-	-	-	-	
-	-	-	-	-	-	-	-	-	
				100	PPTXFx	120	70	330	95
				125	PPTXF2	132	90	340	135
				175/175	PBRTF6	210	135	290	15
				180/200	PBRTF0	240	155	240	15

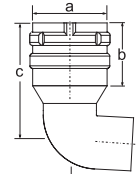
<b>FLEX Adapter starr/flex 87°</b> FLEX Adapter starr/flex 87° • FLEX Adaptador rígido/flex 87° • FLEX Adaptör starr/flex 87° • FLEX Προσαρμογέας starr/flex 87°									
		Ø	Code Código	Kod Κωδ.	a (mm)	b (mm)	c (mm)	d (mm)	
		60	PPAF55	61	60	140	105	-	
80	PPAF58	81	60	115	100	-	-	-	
100	PPAF5X	104	72	147	113	-	-	-	
125	PPAF52	133	72	135	130	-	-	-	
-	-	-	-	-	-	-	-	-	
		160/175	PBAF96	210	145	160	-	-	
		180/200	PBAF90	240	300	300	-	-	
		-	-	-	-	-	-	-	
		-	-	-	-	-	-	-	
		-	-	-	-	-	-	-	

<b>FLEX Adapter starr/flex 87° (reduced)</b> FLEX Adapter starr/flex 87° reduziert • FLEX Adaptador rígido/flex 87° reducido • FLEX Adaptör starr/flex 87° (azaltılmış) • FLEX Προσαρμογέας flex 87° (συστολικός)									
		Ø	Code Código	Kod Κωδ.	a (mm)	b (mm)	c (mm)	d (mm)	
		60/80	PPAF58	81	60	115	60	-	
80/100	PPAF8X	104	72	147	80	-	-		
110/100	PPAF1X	104	72	147	110	-	-		
100/125	PPAFX2	133	72	135	100	-	-		
110/125	PPAF12	133	72	135	110	-	-		
-	-	-	-	-	-	-	-	-	

**FLEX**

# FLEXIBLE GAS FLUE SYSTEM

**FLEX**  
PPH

FLEXIBLES ABGASSYSTEM

SISTEMA DE EVACUACIÓN PARA EL INTERIOR - FLEXIBLE

ESNEK GAZ BACA SÍSTEMI



ΕΥΚΑΜΠΤΟ ΣΥΣΤΗΜΑ ΚΑΠΝΟΔΟΧΟΥ

**Ø60 – 200 mm**

FLEX

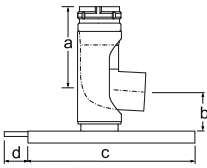

## FLEX Chimney support elbow flex 87° w. anchoring

FLEX Kaminabstützung flex • FLEX Codo soporte chimenea flex 87° c. anclaje • FLEX Baca destek dirseği flex 87° w. ankrāj • FLEX Καμπύλη στερέωσης flex 87° με αγκύρωση

		Ø	Code Código	Kod Κωδ.	a (mm)	b (mm)	c (mm)	d (mm)	
		60	PPSTF5		140	105	350	50	
		80	PPSTF8		115	105	350	50	
		100	PPSTFX		147	130	350	50	
		110 / 100	PPSTF1		147	140	350	50	
		125	PPSTF2		135	100	350	50	
		160 / 175	PBTUF6		280	110	350	50	
		180 / 200	PBTUF0		420	130	650	50	
		-	-		-	-	-	-	
		-	-		-	-	-	-	
		-	-		-	-	-	-	

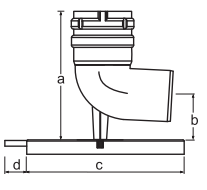

## FLEX heel elbow 87° with a thorn and anchoring

FLEX Bogen 87° m. Auflage • FLEX Codo soporte chimenea flex 87° c. anclaje • FLEX topuk dirseği 87° dikenli ve ankrājlı • FLEX Καμπύλη στερέωσης 87° ακίδας με αγκύρωση (συστολική)

		Ø	Code Código	Kod Κωδ.	a (mm)	b (mm)	c (mm)	d (mm)	
		60	PBUTF5		-	-	-	-	
		80	PBUTF8		-	-	-	-	
		-	-		-	-	-	-	
		-	-		-	-	-	-	
		-	-		-	-	-	-	

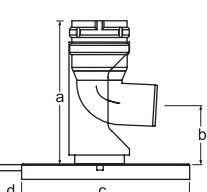

## FLEX Chimney support elbow flex 87° w. anchoring (reduced)

FLEX Kaminabstützung flex reduziert • FLEX Codo soporte chimenea flex 87° reducido c. anclaje • FLEX Baca destek dirseği flex 87° w. ankrāj (azaltılmış) • FLEX Καμπύλη στερέωσης flex 87° με αγκύρωση (συστολική)

		Ø	Code Código	Kod Κωδ.	a (mm)	b (mm)	c (mm)	d (mm)	
		60/80	PPSTF58		220	100	350	50	
		80/110	PPSTF8X		220	100	350	50	
		110/125	PPSTF12		335	105	350	50	
		-	-		-	-	-	-	
		-	-		-	-	-	-	
		-	-		-	-	-	-	

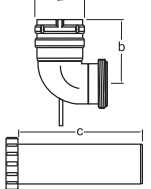

## FLEX Elbow flex 87° for lining

FLEX Basisbogen 87° m. Schraubv. und Anschlussrohr (2-teilig) • FLEX Codo base 87° c. tubo conex. (2 piezas) • Destekli astar için FLEX Dirsek 87° • FLEX Καμπύλη στερέωσης 87° με προέκταση

		Ø	Code Código	Kod Κωδ.	a (mm)	b (mm)	c (mm)	d (mm)	
		60	PBEF5		61	115	500	-	
		80	PBEF8		81	115	500	-	
		-	-		-	-	-	-	
		-	-		-	-	-	-	
		-	-		-	-	-	-	

## FLEX Elbow 87° for lining with support

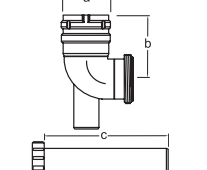
FLEX Basisbogen 87° m. Abstützung, Schraubv. u. Anschlussrohr (2-teilig) • FLEX Codo base 87° c. apoyo y tubo conex. (2 piezas) • Destekli astar için FLEX Dirsek 87° • FLEX Καμπύλη στερέωσης 87° με προέκταση και υποστήριξη

		Ø	Code Código	Kod Κωδ.	a (mm)	b (mm)	c (mm)	d (mm)	
		60	PBESF5		61	115	500	-	
		80	PBESF8		81	115	500	-	
		-	-		-	-	-	-	
		-	-		-	-	-	-	
		-	-		-	-	-	-	

# FLEXIBLE GAS FLUE SYSTEM

**FLEX**  
PPH

FLEXIBLES ABGASSYSTEM

SISTEMA DE EVACUACIÓN PARA EL INTERIOR - FLEXIBLE

ESNEK GAZ BACA SİSTEMİ

ΕΥΚΑΜΠΤΟ ΣΥΣΤΗΜΑ ΚΑΠΝΟΔΟΧΟΥ

**Ø60 – 200 mm**

**FLEX Elbow 87° for lining (reduced)**  
FLEX Basisbogen 87° reduziert m. Schraubv. u. Anschlussrohr (2-teilig) • FLEX Codo base 87° reducido c. tubo conex. (2 piezas) • Astar için FLEX Dirsek 87° (azaltılmış) • FLEX Καμπύλη στερέωσης 87° με προέκταση (συστολική)

Ø	Code Código	Kod Κωδ.	a (mm)	b (mm)	c (mm)	d (mm)	ⓘ
60/80	PBEBF58		81	60	500	-	
-	-	-	-	-	-	-	
-	-	-	-	-	-	-	
-	-	-	-	-	-	-	
-	-	-	-	-	-	-	

**FLEX Elbow 87° for lining with support (reduced)**  
FLEX Basisbogen 87° reduziert m. Abstützung, Schraubv. u. Anschlussrohr (2-teilig) • FLEX Codo base 87° reducido c. apoyo y tubo conex. (2 piezas) • FLEX Dirsek 87° destekli astar için (azaltılmış) • FLEX Καμπύλη στερέωσης 87° με προέκταση και υποστήριξη (συστολική)

Ø	Code Código	Kod Κωδ.	a (mm)	b (mm)	c (mm)	d (mm)	ⓘ
60/80	PBESF58		81	60	500	-	
-	-	-	-	-	-	-	
-	-	-	-	-	-	-	
-	-	-	-	-	-	-	
-	-	-	-	-	-	-	

**FLEX Heel elbow 87° with a thorn and anchoring (reduced)**  
FLEX Bogen 87° m. Auflage • FLEX Codo soporte chimenea 87° c. anclaje • FLEX topuk dirseği 87° dikenli ve ankrajlı (azaltılmış) • FLEX Καμπύλη στερέωσης 87° ακίδας με αγκύρωση (συστολική)

Ø	Code Código	Kod Κωδ.	a (mm)	b (mm)	c (mm)	d (mm)	ⓘ
60 / 80	PBUTF58		-	-	-	-	
-	-	-	-	-	-	-	
-	-	-	-	-	-	-	
-	-	-	-	-	-	-	
-	-	-	-	-	-	-	

**FLEX Seal for bayonet closure**  
FLEX Dichtung Bajonett-Verschluss • FLEX Junta para cierre a bayoneta • Süngü kapatma için FLEX Conta • FLEX Δακτύλιος

Ø	Code Código	Kod Κωδ.	a (mm)	b (mm)	c (mm)	d (mm)	ⓘ
60	ZUMDF5		66	-	-	-	
80	ZUMDF8		86	-	-	-	
100	ZUMDFX		106	-	-	-	
125	ZUMDF2		132	-	-	-	

**FLEX Hose clip for flex connection**  
FLEX Klemmband für Flexverbindung • FLEX Brida flex • FLEX Esnek bağlantı için hortum klipsi • FLEX Ασφάλεια σύνδεσης

Ø	Code Código	Kod Κωδ.	a (mm)	b (mm)	c (mm)	d (mm)	ⓘ
60	ZUBF05		70	60	-	-	
80	ZUBF08		90	60	-	-	
100	ZUBFOX		115	60	-	-	
125	ZUBF02		135	60	-	-	

**FLEX Safety clamp flex (top)**  
FLEX Sicherungsklammer für Flex oben • FLEX Clip de fijación flex (arriba) • FLEX Güvenlik kelepçesi flex (üst) • FLEX Κολάρο στήριξης

Ø	Code Código	Kod Κωδ.	a (mm)	b (mm)	c (mm)	d (mm)	ⓘ
60	ZUHF05		60	90	-	-	
80	ZUHF08		80	110	-	-	
100	ZUHFOX		100	135	-	-	
125	ZUHFO2		125	160	-	-	

# FLEXIBLE GAS FLUE SYSTEM

**FLEX**  
PPH

FLEXIBLES ABGASSYSTEM

SISTEMA DE EVACUACIÓN PARA EL INTERIOR - FLEXIBLE

ESNEK GAZ BACA SÍSTEMİ

ΕΥΚΑΜΠΤΟ ΣΥΣΤΗΜΑ ΚΑΠΝΟΔΟΧΟΥ

**Ø60 – 200 mm**

FLEX

## FLEX Safety clamp flex w. clamping arm

FLEX Sicherungsklammer für Flex m. Armen • FLEX Clip de fijación flex con brazos sujeción • FLEX Güvenlik kelepçesi flex w. sıkıştırma kolu • FLEX Κολάρο στήριξης με λάμες

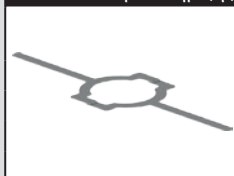
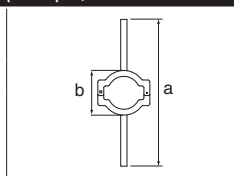
		Ø	Code	Kod	a (mm)	b (mm)	c (mm)	d (mm)	i
			Código	Κωδ.					
		60	ZUHFA5		370	90	-	-	
		80	ZUHFA8		390	110	-	-	
		100	ZUHFA8		415	135	-	-	
		125	ZUHFA2		415	160	-	-	

## FLEX Locking ring

FLEX Sicherungsring • FLEX Clip de bloqueo • FLEX Kilitleme halkası • FLEX Ασφάλεια προσαρμογέα

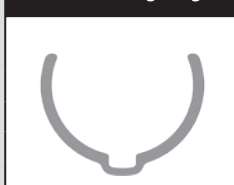
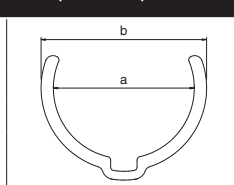
		Ø	Code	Kod	a (mm)	b (mm)	c (mm)	d (mm)	i
			Código	Κωδ.					
		60	ZUHFK5		60	90	-	-	
		80	ZUHFK8		80	110	-	-	
		100	ZUHFKX		100	135	-	-	
		125	ZUHFK2		125	160	-	-	

## STARR Plastic chimney top (complete)

STARR Kaminabschluss (komplett) • STARR Salida techo (completa) • STARR Plastik baca tepesi (komple) • STARR Πλαστικό κάλυμμα καπνοδόχου (πλήρες)

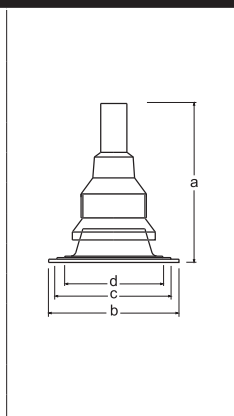
		Ø	Code	Kod	a (mm)	b (mm)	c (mm)	d (mm)	i
			Código	Κωδ.					
		60	PPSAS5		495	400	350	300	black schwarz negro siyah Μαύρο χρώμα
		80	PPSAS8		500	400	350	300	
		100	PPSASX		500	400	350	300	
		110	PPSAS1		500	400	350	300	
		125	PPSAS2		500	400	350	300	
		60	PPBAS5		495	400	350	300	brown braun marrón kahverengi ΚΑφέ χρώμα
		80	PPBAS8		500	400	350	300	
		100	PPBASX		500	400	350	300	
		110	PPBAS1		500	400	350	300	
		125	PPBAS2		500	400	350	300	
		160	PPBAS6		500	400	350	300	

## FLEX Plastic chimney top flex (complete)

FLEX Kaminabschluss (komplett) • FLEX Salida techo (completa) • FLEX Plastik baca üst fleksi (komple) • FLEX Πλαστικό κάλυμμα καπνοδόχου flex (πλήρες)

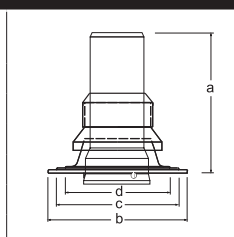
		Ø	Code	Kod	a (mm)	b (mm)	c (mm)	d (mm)	i
			Código	Κωδ.					
		160	PPSAF6		440	400	350	300	black schwarz negro siyah Μαύρο χρώμα
		-	-		-	-	-	-	
		-	-		-	-	-	-	
		-	-		-	-	-	-	
		-	-		-	-	-	-	
		-	-		-	-	-	-	

## FLEX Stainless chimney top flex (complete)

FLEX Kaminabschluss flex Est. (komplett) • FLEX Salida techo flex Inox (completa) • FLEX Paslanmaz baca üst fleksi (komple) • FLEX Κάλυμμα καπνοδόχου (πλήρες)

		Ø	Code	Kod	a (mm)	b (mm)	c (mm)	d (mm)	i
			Código	Κωδ.					
		200	ESTAFO		400	400	-	-	Stainless steel Edelstahl Acero inoxidable Paslanmaz çelik Ανοξειδωτος χάλυβας
		-	-		-	-	-	-	
		-	-		-	-	-	-	
		-	-		-	-	-	-	
		-	-		-	-	-	-	
		-	-		-	-	-	-	

# FLEXIBLE GAS FLUE SYSTEM

**FLEX**  
PPH

FLEXIBLES ABGASSYSTEM

SISTEMA DE EVACUACIÓN PARA EL INTERIOR - FLEXIBLE

ESNEK GAZ BACA SİSTEMİ

ΕΥΚΑΜΠΤΟ ΣΥΣΤΗΜΑ ΚΑΠΝΟΔΟΧΟΥ

**Ø60 – 200 mm**

<b>STARR Rain collar</b> STARR Wetterkragen • STARR Collarín antilluvia • STARR Yağmurluk • STARR Προστατευτικό βροχής									
		Ø	Code Código	Kod Κωδ.	a (mm)	b (mm)	c (mm)	d (mm)	i
		60	PPWS05		61	100	120	-	
80	PPWS08		81	75	120	-			
100	PPWS0X		101	145	135	-			
110	PPWS01		111	135	135	-			
125	PPWS02		127	130	204	-			
160	PPWS06		162	100	204	-			
60	PPWB05		61	100	120	-	<b>brown</b> braun marrón kahverengi Καφέ χρώμα		
80	PPWB08		81	75	120	-			
100	PPWB0X		101	145	135	-			
110	PPWB01		111	135	135	-			
125	PPWB02		127	130	204	-			
160	PPWB06		162	100	204	-			

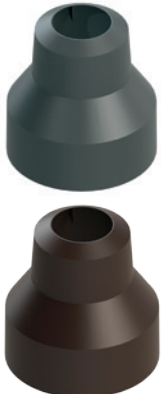
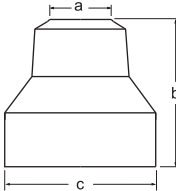
<b>STARR Tapered rain collar</b> STARR Wetterkragen f. Mantelrohr • STARR Collarín antilluvia cónico • STARR Konik yağmur yaka • STARR Κωνικό προστατευτικό βροχής									
		Ø	Code Código	Kod Κωδ.	a (mm)	b (mm)	c (mm)	d (mm)	i
		60	PPWS52		61	230	200	-	
80	PPWS82		81	206	200	-			
100	PPWSX2		100	180	200	-			
110	PPWS12		110	170	200	-			
-	-		-	-	-	-			
-	-		-	-	-	-			
60	PPWB52		61	230	200	-	<b>brown</b> braun marrón kahverengi Καφέ χρώμα		
80	PPWB82		81	206	200	-			
100	PPWBX2		100	180	200	-			
110	PPWB12		110	170	200	-			
-	-		-	-	-	-			
-	-		-	-	-	-			

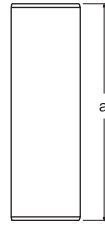
<b>STARR End pipe without socket</b> STARR Mündungsrohr • STARR Tubo terminal M/M • STARR Soketsiz uç borusu • STARR Τελικός σωλήνας χωρίς υποδοχή										
		0,50 m	Ø	Code Código	Kod Κωδ.	a (mm)	b (mm)	c (mm)	d (mm)	i
			60	PPRS55		495	-	-	-	
80	PPRS58		500	-	-	-				
100	PPRS5X		500	-	-	-				
110	PPRS51		500	-	-	-				
125	PPRS52		500	-	-	-				
-	-		-	-	-	-				

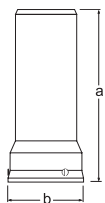
<b>FLEX End pipe w. flex coupler</b> FLEX Mündungsrohr m. Flexkupplung • FLEX Tubo terminal c. acoplador flex • FLEX Uç borusu w. flex kuplör • FLEX Τερματικός σωλήνας flex										
		0,30 m	Ø	Code Código	Kod Κωδ.	a (mm)	b (mm)	c (mm)	d (mm)	i
			160	PPRSF6		270	210	-	-	
200	PPRSF0		260	240	-	-				
-	-		-	-	-	-				
-	-		-	-	-	-				
-	-		-	-	-	-				
-	-		-	-	-	-				

**FLEX**

# FLEXIBLE GAS FLUE SYSTEM

**FLEX**  
PPH

FLEXIBLES ABGASSYSTEM

SISTEMA DE EVACUACIÓN PARA EL INTERIOR - FLEXIBLE

ESNEK GAZ BACA SÍSTEMİ

ΕΥΚΑΜΠΤΟ ΣΥΣΤΗΜΑ ΚΑΠΝΟΔΟΧΟΥ

**Ø60 – 200 mm**

FLEX

**STARR Extension for chimney head**  
STARR Kaminplattenverlängerung aus Kst. • STARR Extensión para salida techo • STARR Baca başlığı için uzatma • STARR Προέκταση πλάκας καπέλου καπνοδόχου

Ø	Code Código	Kod Κωδ.	a (mm)	b (mm)	c (mm)	d (mm)	i
60-175	PPKMS0		200	170	-	-	<b>black</b> schwarz negro siyah Μαύρο χρώμα
-	-		-	-	-	-	
60-175	PPKMB0		200	170	-	-	<b>brown</b> braun marrón kahverengi Καφέ χρώμα
-	-		-	-	-	-	

**FLEX Pull through head**  
FLEX Einzugshilfe f. Flexrohre • FLEX Cabezal de arrastre pr. flex • FLEX Başlık boynunca çekin • FLEX Εργαλείο τοποθέτησης εύκαμπτου

Ø	Code Código	Kod Κωδ.	a (mm)	b (mm)	c (mm)	d (mm)	i
60	ZUEZH5		-	-	-	-	<b>Rope is not supplied</b> Kopfteil ohne Seil Cabezal sin cuerda Halat tedarik edilmedi Δεν περιλαμβάνεται σχοινί
80	ZUEZH8		-	-	-	-	
110	ZUEZH1		-	-	-	-	
125	ZUEZH2		-	-	-	-	
160	ZUEZH6		-	-	-	-	
200	ZUEZH0		-	-	-	-	

**FLEX Secure ring**  
FLEX Bremsring Metall • FLEX Anillo de fijación • FLEX Güvenlik halkası • FLEX Δακτύλιος ασφαλείας

Ø	Code Código	Kod Κωδ.	a (mm)	b (mm)	c (mm)	d (mm)	i
80	ZUBR08		-	-	-	-	
110	ZUBR01		-	-	-	-	
-	-		-	-	-	-	
-	-		-	-	-	-	
-	-		-	-	-	-	
-	-		-	-	-	-	



# INTERNAL CONCENTRIC AIR-GAS FLUE SYSTEM

KONZENTRISCHES LUFT-ABGASSYSTEM

SISTEMA DE EVACUACIÓN CONCÉNTRICO PARA EL INTERIOR

DAHILI KONSANTRIK HAVA-GAZ BACA SISTEMI

ΟΜΟΚΕΝΤΡΙΚΟ ΣΥΣΤΗΜΑ ΚΑΠΝΟΔΟΧΟΥ ΕΣΩΤΕΡΙΚΗΣ ΧΡΗΣΗΣ

**Ø60/100 – 80/125 mm**

**LIK**

**PPH/PPH – white**

PPH/PPH – weiss

PPH/PPH – blanco

PPH/PPH – beyaz

PPH/PPH – λευκό

1	LPW2L5
2	LPRK05
3	LPSK25
4	LPRTK5
5	LPUK05
6	LPMK51

LIK			
Ø (mm)	Inner dimension of socket Innenmass des Rohres Dimensión interior del tubo Soketin iç boyutu Εσωτερική διατομή υποδοχής (mm)	Wall thickness Wandstärke Espesor de pared Duvar kalınlığı Πάχος τοιχώματος (mm)	Outer dimension of socket Ausssenmass der Muffe Dimensión exterior del manguito Soketin dış boyutu Εξωτερική διατομή υποδοχής (mm)
60/100	96	2,0	110
80/125	122	2,0	135

LIK

**When assembling horizontal piping, it is necessary to create a slope towards the boiler at minimum of 3°.**

Gefälle schaffen waagerechte Verbindungsleitung muss zum Kessel immer ein Gefälle von mindestens 3° haben.

Al montar las tuberías horizontales, es necesario crear una pendiente hacia la caldera de un mínimo de 3°.

Yatay boru tesisatını monte ederken, kazana doğru en az 3°'lik bir eğim oluşturmak gerekir.

Κατά την εγκατάσταση οριζόντιων σωληνώσεων, πρέπει να υπάρχει κλίση προς τον λέβητα τουλάχιστον 3°.

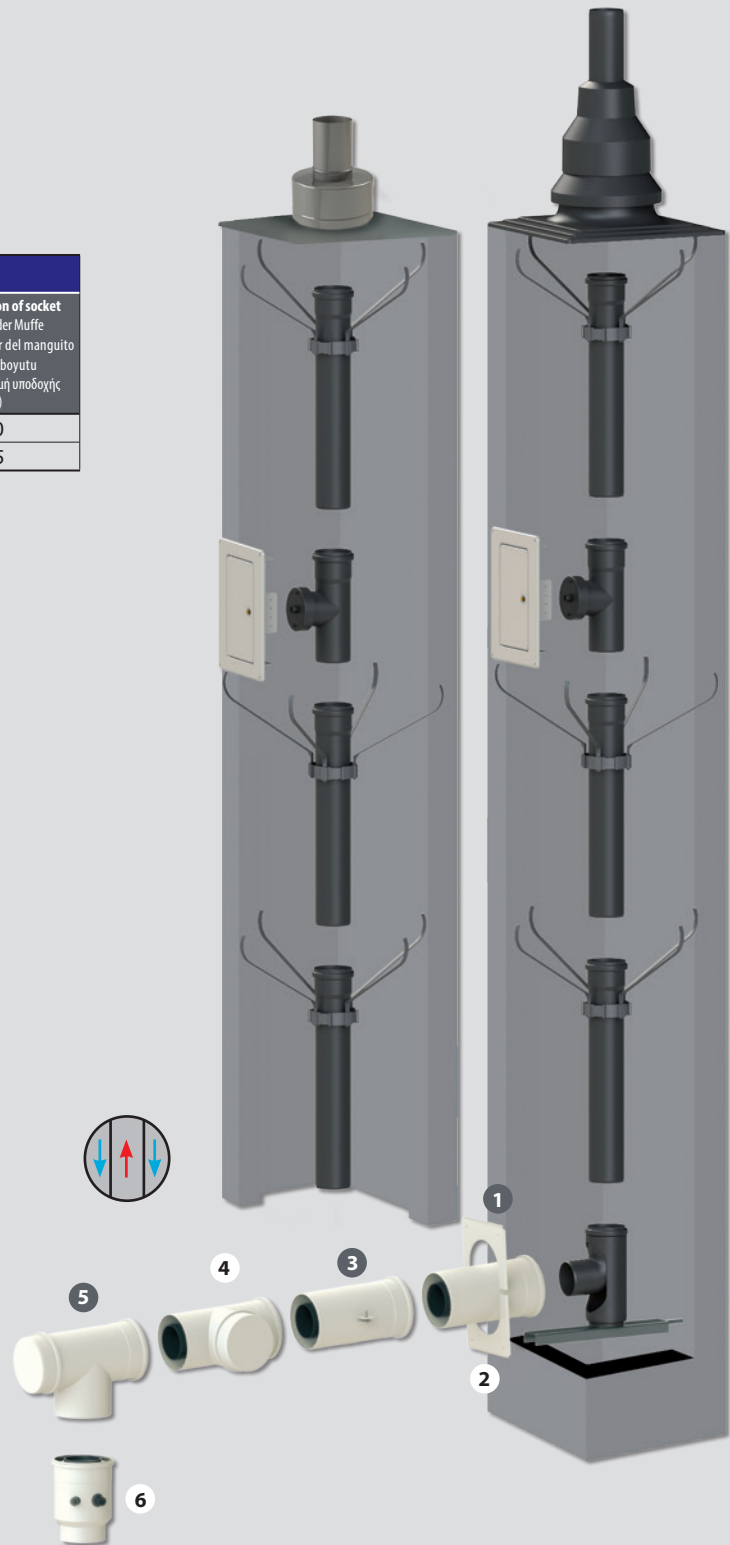

# INTERNAL CONCENTRIC AIR-GAS FLUE SYSTEM

**LIK**

KONZENTRISCHES LUFT-ABGASSYSTEM

**PPH/PPH – white**

SISTEMA DE EVACUACIÓN CONCÉNTRICO PARA EL INTERIOR

PPH/PPH – weiss

DAHILI KONSANTRIK HAVA-GAZ BACA SİSTEMİ



PPH/PPH – blanco

ΟΜΟΚΕΝΤΡΙΚΟ ΣΥΣΤΗΜΑ ΚΑΠΝΟΔΟΧΟΥ ΕΣΩΤΕΡΙΚΗΣ ΧΡΗΣΗΣ

PPH/PPH – beyaz

PPH/PPH – λευκό

**Ø60/100 – 80/125 mm**

3 Variants of appliance connection					
Kesselanschlüsse in 3 Varianten 3 Variantes de aplicación		3 Cihaz bağlantısı çeşitleri 3 παραλλαγές σύνδεσης συσκευών			
Variant I		Variant II		Variant III	
Variante I	Varyant I	Variante II	Varyant II	Variante III	Varyant III
Variante I	Παραλλαγή I	Variante II	Παραλλαγή II	Variante III	Παραλλαγή III
					
LIK boiler adapter		LIK boiler adapter with 2 test plugs		LIK Boiler Adapter-Tee with test plug (reduced)	
LIK Kesseladapter	LIK Kazan adaptörü	LIK Messstück reduziert	LIK 2 test fişli kazan adaptörü	LIK Umlenk-T m. MÖ (reduziert)	LIL Kontrol kapılı Tee
LIK Adaptador a caldera	LIK συστολή λέβητα	LIK Adapt. caldera con 2 tm./muestras	LIK συστολή λέβητα με σημείο μέτρησης	LIK Te-Adapt. cald. con tm./muestras	LIK Ταφ σύνδεσης λέβητα με σημείο μέτρησης (αυτοσκοπικό)
Ø (combustion gas piping) (Abgasleitung) (tubos combustión humos) (yanma gazı boru tesisatı) (σωλήνες καυσαερίων)	Ø (socket of the appliance) (Kesselstutzen) (aplicación a caldera) (cihazın soketi) (υποδοχή συσκευής)	Ø (combustion gas piping) (Abgasleitung) (tubos combustión humos) (yanma gazı boru tesisatı) (σωλήνες καυσαερίων)	Ø (socket of the appliance) (Kesselstutzen) (aplicación a caldera) (cihazın soketi) (υποδοχή συσκευής)	Ø (combustion gas piping) (Abgasleitung) (tubos combustión humos) (yanma gazı boru tesisatı) (σωλήνες καυσαερίων)	Ø (socket of the appliance) (Kesselstutzen) (aplicación a caldera) (cihazın soketi) (υποδοχή συσκευής)
60/100 80/125	60/100 63/96 70/100 70/110 80/110 80/122 80/126 80/130 100/150	60/100 80/125	60/100 63/96 70/110 80/110 80/126 80/130 110/160	60/100 80/125	60/100 63/96 70/110 80/110 80/126 80/130

LPMSKS	LPMSKS-LET
	
	a = 30 mm
<p><b>LET – components are used as adapter for socket on boiler</b></p> <p>LET – Komponenten werden als Kesseladapter verwendet</p> <p>LET – Estos componentes se utilizan como adaptador a caldera</p> <p>LET – bileşenler kazan üzerindeki soket için adaptör olarak kullanılır</p> <p>LET – Εξάρτημα σύνδεσης λέβητα</p>	

**LIK**

# INTERNAL CONCENTRIC AIR-GAS FLUE SYSTEM

**LIK**

KONZENTRISCHES LUFT-ABGASSYSTEM

**PPH/PPH – white**

SISTEMA DE EVACUACIÓN CONCÉNTRICO PARA EL INTERIOR

PPH/PPH – weiss

DAHILI KONSANTRIK HAVA-GAZ BACA SISTEMI

PPH/PPH – blanco

ΟΜΟΚΕΝΤΡΙΚΟ ΣΥΣΤΗΜΑ ΚΑΠΝΟΔΟΧΟΥ ΕΣΩΤΕΡΙΚΗΣ ΧΡΗΣΗΣ

PPH/PPH – beyaz

PPH/PPH – λευκό

**Ø60/100 – 80/125 mm**

## LIK Pipe with socket

LIK Rohr m. Muffe • LIK Tubo M/H • LIK Soketli boru • LIK Σωλήνα με υποδοχή (κεφάλι)

	Ø	Code Código	Kod Κωδ.	a (mm)	b (mm)	c (mm)	d (mm)
	250 mm	60/100	LPRK05	104	52	198	-
		60/100	LPRK05-LET	104	52	198	-
		80/125	LPRK08	130	52	198	-
	500 mm	60/100	LPRK55	104	52	448	-
		80/125	LPRK58	130	52	448	-
		-	-	-	-	-	-
	1000 mm	60/100	LPRK15	104	52	948	-
		80/125	LPRK18	130	52	948	-
		-	-	-	-	-	-
	2 000 mm	60/100	LPRK25	104	52	1948	-
		80/125	LPRK28	130	52	1948	-
		-	-	-	-	-	-

## LIK Adjustable pipe with clamp

LIK Schieberohr • LIK Tubo extensible • LIK Keleρχeli ayarlanabilir boru • LIK Πτυσσόμενος σωλήνας

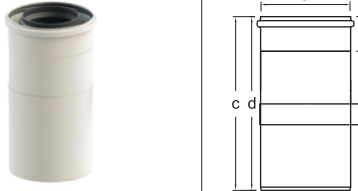
	Ø	Code Código	Kod Κωδ.	a (mm)	b (mm)	c (mm)	d (mm)
	230-290mm	60/100	LPSK25	104	52	180	310
		80/125	LPSK28	130	52	180	310
		-	-	-	-	-	-
	320-560mm	60/100	LPSK55	104	52	330	610
		80/125	LPSK58	130	52	370	610
		-	-	-	-	-	-

## LIK Inspection-Tee

LIK Revisions-T • LIK Te-Inspección • LIK Muayene -T • LIK Ταφ με θυρίδα επιθεώρησης

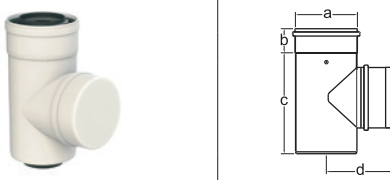
	Ø	Code Código	Kod Κωδ.	a (mm)	b (mm)	c (mm)	d (mm)
	60/100	LPRTK5	104	52	230	142	
	80/125	LPRTK8	130	52	270	142	
	-	-	-	-	-	-	
	-	-	-	-	-	-	
	-	-	-	-	-	-	
	-	-	-	-	-	-	

## LIK Inspection-Tee w. test plug

LIK Revisions-T m. MÖ • LIK Te-Inspección c. tm./muestras • LIK Muayene-Tee w. test fişi • LIK Ταφ με θυρίδα επιθεώρησης και σημείο μέτρησης

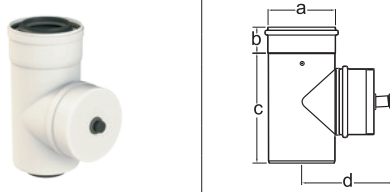
	Ø	Code Código	Kod Κωδ.	a (mm)	b (mm)	c (mm)	d (mm)
	60/100	LPRMK5	104	52	230	175	
	80/125	LPRMK8	130	52	270	180	
	-	-	-	-	-	-	
	-	-	-	-	-	-	
	-	-	-	-	-	-	
	-	-	-	-	-	-	

# INTERNAL CONCENTRIC AIR-GAS FLUE SYSTEM

**LIK**

KONZENTRISCHES LUFT-ABGASSYSTEM

**PPH/PPH – white**

SISTEMA DE EVACUACIÓN CONCÉNTRICO PARA EL INTERIOR

PPH/PPH – weiss

DAHILI KONSANTRIK HAVA-GAZ BACA SISTEMI

PPH/PPH – blanco

ΟΜΟΚΕΝΤΡΙΚΟ ΣΥΣΤΗΜΑ ΚΑΠΝΟΔΟΧΟΥ ΕΣΩΤΕΡΙΚΗΣ ΧΡΗΣΗΣ

PPH/PPH – beyaz

PPH/PPH – λευκό

## Ø60/100 – 80/125 mm

### LIK Deflection-Tee w. inspection

LIK Umlenk-T m. Rev.-Deckel • LIK Te-Desvío con inspección • LIK Sarma-Tee w. denetimi • LIK Ταφ με θυρίδα επιθεώρησης με αλλαγή κατεύθυνσης

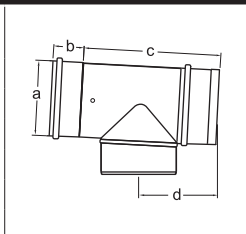

Ø	Code Código	Kod Κωδ.	a (mm)	b (mm)	c (mm)	d (mm)
60/100	LPUK05		104	52	250	125
60/100	LPUK05-LET		104	52	250	125
80/125	LPUK08		130	52	290	140
80/125	LPUK08-LET		130	52	290	140
-	-	-	-	-	-	-
-	-	-	-	-	-	-

### LIK Deflection-Tee with test plug

LIK Umlenk-T m. MÖ • LIK Te-Desvío con tm/muestras • LIK Test tapalı Sarma T'si • LIK Ταφ με θυρίδα επιθεώρησης με αλλαγή κατεύθυνσης και σημείο μέτρησης

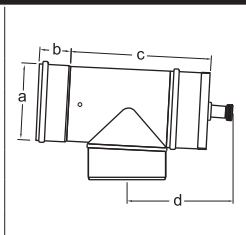

Ø	Code Código	Kod Κωδ.	a (mm)	b (mm)	c (mm)	d (mm)
60/100	LPUMK5		104	52	238	165
60/100	LPUMK5-LET		104	52	238	165
80/125	LPUMK8		130	52	288	190
80/125	LPUMK8-LET		130	52	288	190
-	-	-	-	-	-	-
-	-	-	-	-	-	-

### LIK Drain-Tee (horizontal)

LIK Ablauf-T horizontal • LIK Te-Desc./condensados horizontal • LIK Drain-Tee (yatay) • LIK Ταφ με θυρίδα επιθεώρησης και αποστράγγιση

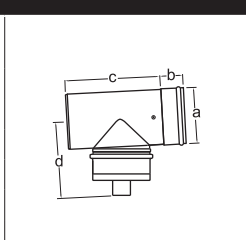
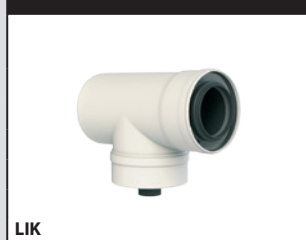

Ø	Code Código	Kod Κωδ.	a (mm)	b (mm)	c (mm)	d (mm)
60/100	LPRKA5		104	52	178	185
80/125	LPRKA8		130	52	218	190
-	-	-	-	-	-	-
-	-	-	-	-	-	-
-	-	-	-	-	-	-
-	-	-	-	-	-	-

### LIK Deflection-Tee with drain

LIK Umlenk-T m. Ablauf • LIK Te-Desvío con desc./cond. • LIK Drenajlı Saptırma Tee • LIK Ταφ με θυρίδα επιθεώρησης με αποστράγγιση και αλλαγή κατεύθυνσης

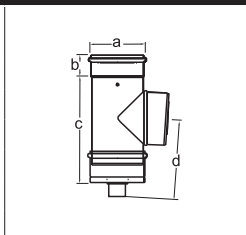

Ø	Code Código	Kod Κωδ.	a (mm)	b (mm)	c (mm)	d (mm)
60/100	LPUKA5		104	52	238	165
80/125	LPUKA8		130	52	288	190
-	-	-	-	-	-	-
-	-	-	-	-	-	-
-	-	-	-	-	-	-
-	-	-	-	-	-	-

### LIK Connecting-Tee

LIK Verbindungs-T • LIK Te-Empalme • LIK Bağlama - Tee • LIK Ταφ σύνδεσης

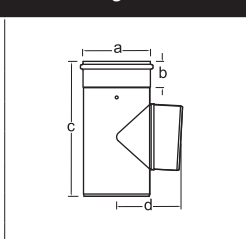

Ø	Code Código	Kod Κωδ.	a (mm)	b (mm)	c (mm)	d (mm)
60/100	LPVTK5		104	52	250	125
80/125	LPVTK8		130	52	290	140
-	-	-	-	-	-	-
-	-	-	-	-	-	-
-	-	-	-	-	-	-
-	-	-	-	-	-	-

LIK

LIK

# INTERNAL CONCENTRIC AIR-GAS FLUE SYSTEM

**LIK**

KONZENTRISCHES LUFT-ABGASSYSTEM

**PPH/PPH – white**

SISTEMA DE EVACUACIÓN CONCÉNTRICO PARA EL INTERIOR

PPH/PPH – weiss

DAHILI KONSANTRIK HAVA-GAZ BACA SISTEMI

PPH/PPH – blanco

ΟΜΟΚΕΝΤΡΙΚΟ ΣΥΣΤΗΜΑ ΚΑΠΝΟΔΟΧΟΥ ΕΣΩΤΕΡΙΚΗΣ ΧΡΗΣΗΣ

PPH/PPH – beyaz

PPH/PPH – λευκό

**Ø60/100 – 80/125 mm**

## LIK Elbow 15°

LIK Bogen 15° • LIK Codo 15° • LIK Dirsek 15° • LIK Καμπύλη 15°

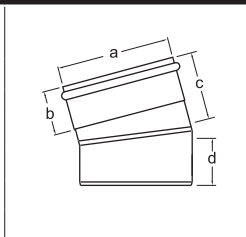

Ø	Code Código	Kod Κωδ.	a (mm)	b (mm)	c (mm)	d (mm)
60/100	LPBK15		104	52	87	65
80/125	LPBK18		130	52	82	65
-	-	-	-	-	-	-
-	-	-	-	-	-	-
-	-	-	-	-	-	-
-	-	-	-	-	-	-

LIK

## LIK Elbow 30°

LIK Bogen 30° • LIK Codo 30° • LIK Dirsek 30° • LIK Καμπύλη 30°

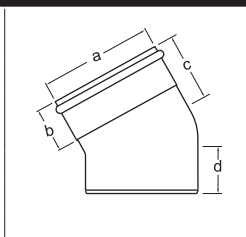

Ø	Code Código	Kod Κωδ.	a (mm)	b (mm)	c (mm)	d (mm)
60/100	LPBK35		104	52	92	78
80/125	LPBK38		130	52	97	85
-	-	-	-	-	-	-
-	-	-	-	-	-	-
-	-	-	-	-	-	-
-	-	-	-	-	-	-

LIK

## LIK Elbow 45°

LIK Bogen 45° • LIK Codo 45° • LIK Dirsek 45° • LIK Καμπύλη 45°

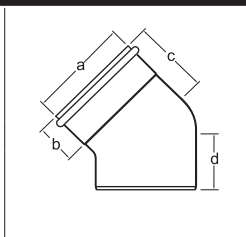

Ø	Code Código	Kod Κωδ.	a (mm)	b (mm)	c (mm)	d (mm)
60/100	LPBK45		104	52	97	95
80/125	LPBK48		130	52	97	80
-	-	-	-	-	-	-
-	-	-	-	-	-	-
-	-	-	-	-	-	-
-	-	-	-	-	-	-

LIK

## LIK Elbow 87°

LIK Bogen 87° • LIK Codo 87° • LIK Dirsek 87° • LIK Καμπύλη 87°

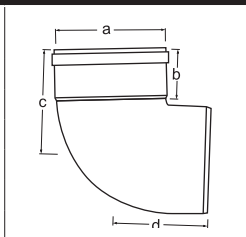

Ø	Code Código	Kod Κωδ.	a (mm)	b (mm)	c (mm)	d (mm)
60/100	LPBK95		104	52	135	123
60/100	LPBK95-LET		104	52	135	123
80/125	LPBK98		130	52	157	135
-	-	-	-	-	-	-
-	-	-	-	-	-	-
-	-	-	-	-	-	-

LIK

## LIK Inspection elbow 87°

LIK Revisionsbogen 87° • LIK Codo inspección 87° • LIK Muayene dirseği 87° • LIK Καμπύλη 87° με θυρίδα επιθεώρησης

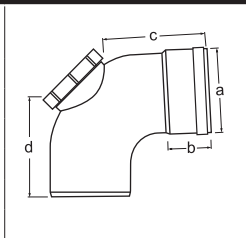

Ø	Code Código	Kod Κωδ.	a (mm)	b (mm)	c (mm)	d (mm)
60/100	LPRBK5		104	52	135	123
80/125	LPRBK8		130	52	157	135
-	-	-	-	-	-	-
-	-	-	-	-	-	-
-	-	-	-	-	-	-
-	-	-	-	-	-	-

LIK

# INTERNAL CONCENTRIC AIR-GAS FLUE SYSTEM

**LIK**

KONZENTRISCHES LUFT-ABGASSYSTEM

**PPH/PPH – white**

SISTEMA DE EVACUACIÓN CONCÉNTRICO PARA EL INTERIOR

PPH/PPH – weiss

DAHILI KONSANTRIK HAVA-GAZ BACA SISTEMI

PPH/PPH – blanco

ΟΜΟΚΕΝΤΡΙΚΟ ΣΥΣΤΗΜΑ ΚΑΠΝΟΔΟΧΟΥ ΕΣΩΤΕΡΙΚΗΣ ΧΡΗΣΗΣ

PPH/PPH – beyaz

PPH/PPH – λευκό

**Ø60/100 – 80/125 mm**

**LIK Inspection elbow 87° w. test plug**  
LIK Rev.-Bogen 87° m. MÖ • LIK Codo inspec. 87° con tm./muestras • LIK Muayene dirseği 87° w. test tapası • LIK Καμπύλη 87° με θυρίδα επιθεώρησης και σημείο μέτρησης

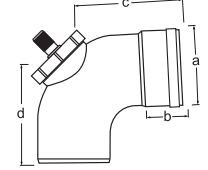
		Ø	Code Código	Kod Κωδ.	a (mm)	b (mm)	c (mm)	d (mm)
		60/100	LPRKM5		104	52	135	123
		60/100	LPRKM5-LET		104	52	135	123
		80/125	LPRKM8		130	52	157	135
		-	-		-	-	-	-
		-	-		-	-	-	-

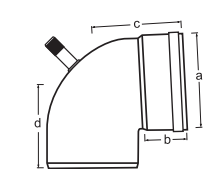

**LIK Elbow 87° with test plugs**  
LIK Bogen 87° m. MÖ • LIK Codo 87° con tm./muestras • LIK Test tapalı 87° dirsek • LIK Καμπύλη 87° με σημείο μέτρησης

		Ø	Code Código	Kod Κωδ.	a (mm)	b (mm)	c (mm)	d (mm)
		60/100	LPBKM5		104	52	135	123
		60/100	LPBKM5-LET		104	52	135	123
		80/125	LPBKM8		130	52	157	135
		80/125	LPBKM8-LET		130	52	157	135
		-	-		-	-	-	-

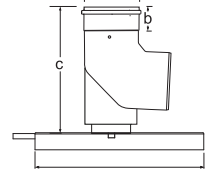

**LIK Chimney support elbow 87° w. anchoring**  
LIK Stützbogen 87° m. Auflageschiene • LIK Codo soporte chimenea 87° c. anclaje • LIK Baca destek dirseği 87° w. ankrāj • LIK Καμπύλη 87° στρέωσης με αγκύρωση

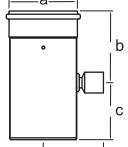
		Ø	Code Código	Kod Κωδ.	a (mm)	b (mm)	c (mm)	d (mm)
		60/100	LPSKK5		104	52	235	350
		80/125	LPSKK8		130	52	257	350
		-	-		-	-	-	-
		-	-		-	-	-	-
		-	-		-	-	-	-

**LIK Condensation trap**  
LIK Kondensatfalle • LIK Descarga condensados • LIK Yoğuşma kapağı • LIK Παγίδα συμπύκνωμάτων

		Ø	Code Código	Kod Κωδ.	a (mm)	b (mm)	
		60/100	LPKFK5		104	80	Installation in horizontal and vertical direction
		80/125	LPKFK8		130	82	Für horizontale und vertikale Installation
		-	-		-	-	Para instalación horizontal y vertical
		-	-		-	-	Yatay ve dikey yönde kurulum
		-	-		-	-	Για οριζόντια ή κάθετη τοποθέτηση

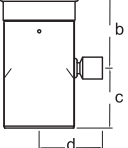
**LIK Condensation trap for air supply**  
LIK Kondensatfalle für Zuluft • LIK Desc./condensados para entrada de aire • LIK Hava beslemesi için yoğuşma kapağı • LIK Παγίδα συμπύκνωμάτων για αέρα καύσης

		Ø	Code Código	Kod Κωδ.	a (mm)	b (mm)	
		60/100	LPKOK5		104	80	Installation in horizontal and vertical direction
		80/125	LPKOK8		130	82	Für horizontale und vertikale Installation
		-	-		-	-	Para instalación horizontal y vertical
		-	-		-	-	Yatay ve dikey yönde kurulum
		-	-		-	-	Για οριζόντια ή κάθετη τοποθέτηση

# INTERNAL CONCENTRIC AIR-GAS FLUE SYSTEM

**LIK**

KONZENTRISCHES LUFT-ABGASSYSTEM

**PPH/PPH – white**

SISTEMA DE EVACUACIÓN CONCÉNTRICO PARA EL INTERIOR

PPH/PPH – weiss

DAHILI KONSANTRIK HAVA-GAZ BACA SISTEMI

PPH/PPH – blanco

ΟΜΟΚΕΝΤΡΙΚΟ ΣΥΣΤΗΜΑ ΚΑΠΝΟΔΟΧΟΥ ΕΣΩΤΕΡΙΚΗΣ ΧΡΗΣΗΣ

PPH/PPH – beyaz

PPH/PPH – λευκό

## Ø60/100 – 80/125 mm

**LIK Measuring piece with 2 test plugs**  
LIK Messstück m. 2 Messöffnungen • LIK Tramo con 2 tm./muestras • LIK 2 test fişli ölçüm parçası • LIK Εξάρτημα με 2 σημεία μέτρησης

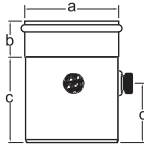
LIK			Ø	Code Código	Kod Kωδ.	a (mm)	b (mm)	c (mm)	d (mm)
			60/100	LPMSK5		104	52	105	80
60/100	LPMSK5-LET		104	52	105	80			
80/125	LPMSK8		130	52	105	80			
80/125	LPMSK8-LET		130	52	105	80			
-	-		-	-	-	-	-	-	-
-	-		-	-	-	-	-	-	-

**LIK Shaft connection with wall rose**  
LIK Schachtanschluss • LIK Pasamuros con remate • LIK Duvar gülü ile shaft bağlantısı • LIK Σωλήνας με ροζέτα

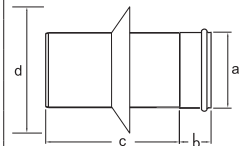
LIK			Ø	Code Código	Kod Kωδ.	a (mm)	b (mm)	c (mm)	d (mm)
			60/100	LPSAK5		104	52	198	165
80/125	LPSAK8		130	52	198	225			
-	-		-	-	-	-	-	-	-
-	-		-	-	-	-	-	-	-
-	-		-	-	-	-	-	-	-
-	-		-	-	-	-	-	-	-

**LIK Tee for air supply**  
LIK Zuluft-T • LIK Te con entrada de aire • LIK Hava beslemesi için Tee • LIK Ταφ για παροχή αέρα

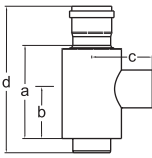
LIK			Ø	Code Código	Kod Kωδ.	a (mm)	b (mm)	c (mm)	d (mm)
			60/100	LPZTK5		140	80	100	260
60-80/100	LPZK58		190	113	113	298			
60-80/100	LPZK58-LET		190	113	113	298			
80/125	LPZTK8		190	113	113	298			
-	-		-	-	-	-	-	-	-
-	-		-	-	-	-	-	-	-

**LIL Wall bracket**  
LIL Decken-Wandhalterung • LIL Anclaje mural • LIL Duvar braketi • LIL Στήριγμα τοίχου

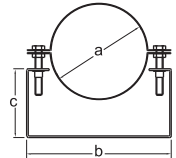
LIL			Ø	Code Código	Kod Kωδ.	a (mm)	b (mm)	c (mm)	d (mm)
			60/100	LPWHL5		100	165	90	-
80/125	LPWHL8		150	190	90	-			
-	-		-	-	-	-	-	-	-
-	-		-	-	-	-	-	-	-
-	-		-	-	-	-	-	-	-
-	-		-	-	-	-	-	-	-

**LIL Wall bracket extension I**  
LIL Wandhalter Verlängerung I • LIL Extensión anclaje mural I • LIL Duvar braketi uzatması I • LIL Προέκταση στηρίγματος τοίχου I

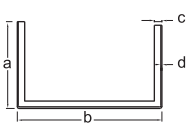
LIL			Ø	Code Código	Kod Kωδ.	a (mm)	b (mm)	c (mm)	d (mm)
			60/100	LPV1L5		100	165	10	2
80/125	LPV1L8		100	185	10	2			
-	-		-	-	-	-	-	-	-
-	-		-	-	-	-	-	-	-
-	-		-	-	-	-	-	-	-
-	-		-	-	-	-	-	-	-

# INTERNAL CONCENTRIC AIR-GAS FLUE SYSTEM

**LIK**

KONZENTRISCHES LUFT-ABGASSYSTEM

**PPH/PPH – white**

SISTEMA DE EVACUACIÓN CONCÉNTRICO PARA EL INTERIOR

PPH/PPH – weiss

DAHILI KONSANTRIK HAVA-GAZ BACA SISTEMI







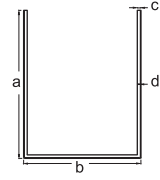

PPH/PPH – blanco

ΟΜΟΚΕΝΤΡΙΚΟ ΣΥΣΤΗΜΑ ΚΑΠΝΟΔΟΧΟΥ ΕΣΩΤΕΡΙΚΗΣ ΧΡΗΣΗΣ

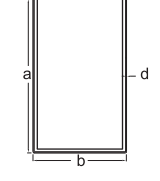
PPH/PPH – beyaz

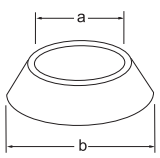
PPH/PPH – λευκό

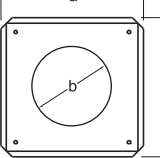
**Ø60/100 – 80/125 mm**

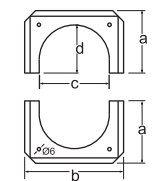
<b>LIL Wall bracket extension II</b> LIL Wandhalter Verlängerung II • LIL Extensión anclaje mural II • LIL Duvar braketi uzatması II • LIL Προέκταση στηρίγματος τοίχου II								
		Ø	Code Código	Kod Kωδ.	a (mm)	b (mm)	c (mm)	d (mm)
		60/100	LPV2L5		250	165	10	2
		80/125	LPV2L8		250	185	10	2
		-	-		-	-	-	-
		-	-		-	-	-	-
		-	-		-	-	-	-
<b>LIL Wall bracket extension III</b> LIL Wandhalter Verlängerung III • LIL Extensión anclaje mural III • LIL Duvar braketi uzatması III • LIL Προέκταση στηρίγματος τοίχου III								
		Ø	Code Código	Kod Kωδ.	a (mm)	b (mm)	c (mm)	d (mm)
		60/100	LPV3L5		335	165	10	2
		80/125	LPV3L8		335	185	10	2
		-	-		-	-	-	-
		-	-		-	-	-	-
		-	-		-	-	-	-
<b>ZUB Wall rose</b> ZUB Wandrosette • ZUB Junta tapamuros • ZUB Duvar gülü • ZUB Ροζέτα								
		Ø	Code Código	Kod Kωδ.	a (mm)	b (mm)	c (mm)	ⓘ
		100	UPRKW5		100	165	-	white weiss • blanco • beyaz • Λευκό
		125	UPRKW8		125	225	-	
		100	UPRKS5		100	165	-	black schwarz • negro • siyah • Μαύρο
		125	UPRKS8		125	225	-	
		-	-		-	-	-	-
<b>LIL One-piece cover plate</b> LIL Abdeckblende • LIL Remate mural • LIL Tek parça kapak plakası • LIL Πλάκα κάλυψης ενός τμήματος								
		Ø	Code Código	Kod Kωδ.	a (mm)	b (mm)	c (mm)	d (mm)
		60/100	LPWL05		250	103	-	-
		80/125	LPWL08		250	128	-	-
		-	-		-	-	-	-
		-	-		-	-	-	-
		-	-		-	-	-	-
<b>LIL Two-piece cover plate</b> LIL Abdeckblende 2-teilig • LIL Remate mural seccionado • LIL İki parçalı kapak plakası • LIL Πλάκα κάλυψης δύο τμημάτων								
		Ø	Code Código	Kod Kωδ.	a (mm)	b (mm)	c (mm)	d (mm)
		60/100	LPW2L5		115	160	101	85
		80/125	LPW2L8		145	180	127	120
		-	-		-	-	-	-
		-	-		-	-	-	-
		-	-		-	-	-	-

**LIK**

# INTERNAL CONCENTRIC AIR-GAS FLUE SYSTEM

**LIK**

KONZENTRISCHES LUFT-ABGASSYSTEM

**PPH/PPH – white**

SISTEMA DE EVACUACIÓN CONCÉNTRICO PARA EL INTERIOR

PPH/PPH – weiss

DAHILI KONSANTRIK HAVA-GAZ BACA SISTEMI

PPH/PPH – blanco

ΟΜΟΚΕΝΤΡΙΚΟ ΣΥΣΤΗΜΑ ΚΑΠΝΟΔΟΧΟΥ ΕΣΩΤΕΡΙΚΗΣ ΧΡΗΣΗΣ

PPH/PPH – beyaz



PPH/PPH – λευκό

**Ø60/100 – 80/125 mm**

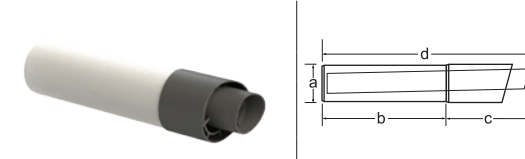
**LIK Wall terminal (horizontal)**  
LIK Ausblasstutzen • LIK Terminal horizontal • LIK Duvar terminali (yatay) • LIK Οριζόντιος τερματικός σωλήνας

	Ø	Code Código	Kod Κωδ.	a (mm)	b (mm)	c (mm)	d (mm)
	60/100	LPASK5			100	360	190
80/125	LPASK8			125	335	215	550
60/100	LPALK5			100	860	190	1050
80/125	LPALK8			125	835	215	1050

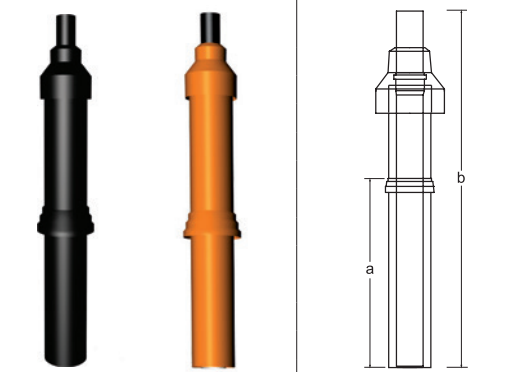
**ZUB Roof terminal adjustable (complete)**  
ZUB Dachaufsatz var. (komplett) • ZUB Terminal vertical var. (completo) • ZUB Tavan terminali ayarlanabilir (komple) • ZUB Κάθετο τερματικό στέγης πτυσσόμενο (πλήρες)

	Ø	Code Código	Kod Κωδ.	a (mm)	b (mm)	
	60/100	DPDS45-V			150-600	1100
80/125	DPDS48-V			150-600	1100	Plástico negro Plastik - siyah Πλαστικό - μαύρο χρώμα
-	-			-	-	
60/100	DPDT45-V			150-600	1100	<b>Plastic - terracotta</b> Kunststoff - terracotta
80/125	DPDT48-V			150-600	1100	Plástico terracota Plastik - terracota Πλαστικό - χρώμα τερακότα
-	-			-	-	
60/100	DPDS15-V			150-1100	1600	<b>Plastic - black</b> Kunststoff - schwarz
80/125	DPDS18-V			150-1100	1600	Plástico negro Plastik - siyah Πλαστικό - μαύρο χρώμα
-	-			-	-	
60/100	DPDT15-V			150-1100	1600	<b>Plastic - terracotta</b> Kunststoff - terracotta
80/125	DPDT18-V			150-1100	1600	Plástico terracota Plastik - terracota Πλαστικό - χρώμα τερακότα
-	-			-	-	

**LIK**

# INTERNAL CONCENTRIC AIR-GAS FLUE SYSTEM

LIK

KONZENTRISCHES LUFT-ABGASSYSTEM

PPH/PPH – white

SISTEMA DE EVACUACIÓN CONCÉNTRICO PARA EL INTERIOR

PPH/PPH – weiss

DAHILI KONSANTRIK HAVA-GAZ BACA SISTEMI

PPH/PPH – blanco

ΟΜΟΚΕΝΤΡΙΚΟ ΣΥΣΤΗΜΑ ΚΑΠΝΟΔΟΧΟΥ ΕΣΩΤΕΡΙΚΗΣ ΧΡΗΣΗΣ

PPH/PPH – beyaz

PPH/PPH – λευκό

**Ø60/100 – 80/125 mm**

**ZUB Universal roof flashing 5° - 55° UNI (complete)**  
 ZUB Universal-Dachpfanne 5° - 55° UNI (komplett) • ZUB Salida techo universal 5° - 55° (completa) • ZUB Üiversal çatı flaşörü 5° - 55° UNI (komple) • ZUB Διάβαση στέγης καπνοδόχου 5° - 55° UNI (πλήρες)

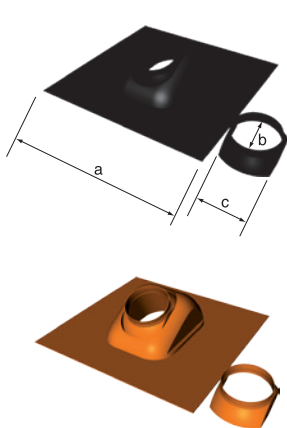
	Ø	Code Código	Kod Κωδ.	a (mm)	b (mm)	c (mm)	ⓘ
	5° - 25°	60/100 - 80/125	ZUD02S	500	138	132	Plastic - black Kunststoff - schwarz Plástico negro Plastik - siyah Πλαστικό - μαύρο
		110/160	ZUD06S	700	165	180	
		60/100 - 80/125	ZUD02T	500	138	132	Plastic - terracotta Kunststoff - terracotta Plástico terracota Plastik - terracota Πλαστικό - τερακότα
		110/160	ZUD06T	700	165	180	
	25° - 45°	60/100 - 80/125	ZUD22S	500	138	132	Plastic - black Kunststoff - schwarz Plástico negro Plastik - siyah Πλαστικό - μαύρο
		110/160	ZUD26S	700	165	180	
		60/100 - 80/125	ZUD22T	500	138	132	Plastic - terracotta Kunststoff - terracotta Plástico terracota Plastik - terracota Πλαστικό - τερακότα
		110/160	ZUD26T	700	165	180	
	35° - 55°	60/100 - 80/125	ZUD32S	500	138	132	Plastic - black Kunststoff - schwarz Plástico negro Plastik - siyah Πλαστικό - μαύρο
		110/160	ZUD36S	700	165	180	
		60/100 - 80/125	ZUD32T	500	138	132	Plastic - terracotta Kunststoff - terracotta Plástico terracota Plastik - terracota Πλαστικό - τερακότα
		110/160	ZUD36T	700	165	180	

**ZUB Roof flashing**  
 ZUB Dachpfanne • ZUB Salida techo • ZUB Baca çatı geçişi • ZUB Διάβαση στέγης καπνοδόχου

	Ø	Code Código	Kod Κωδ.	a (mm)	b (mm)	ⓘ
	60/100 - 80/125	ALPP35	-	-	Plastic - black Kunststoff - schwarz • Plástico negro • Plastik - siyah • Πλαστικό - μαύρο χρώμα	
	-	-	-	-		
	-	-	-	-		

**LIK Boiler adapter**  
 LIK Kesseladapter • LIK Adapt. caldera • LIK Kazan adaptörü • LIK Συστολή λέβητα

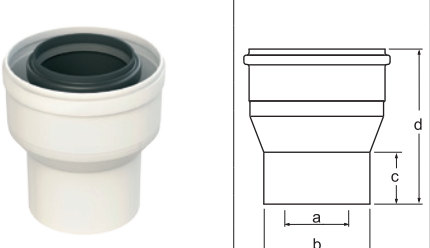
	Ø	Code Código	Kod Κωδ.	a (mm)	b (mm)	c (mm)	d (mm)
	* socket 60/100	63/96	LPKK51	63	96	65	120
		70/100	LPKK50	70	100	65	120
		70/110	LPKK52	70	110	95	150
		80/110	LPKK53	80	110	95	150
		80/126	LPKK54	80	126	75	150
		60/100	LPKK01	60	100	47	120
	* socket 80/125	60/100	LPKK01-LET	60	100	47	120
		63/96	LPKK02	63	96	45	125
		70/100	LPKK03	70	100	45	120
		70/110	LPKK85	70	110	45	120
		80/110	LPKK81	80	110	45	120
		80/122	LPKK04	80	122	60	120
		80/126	LPKK83	80	126	65	120
		80/130	LPKK84	80	130	40	120
		100/150	LPKK82	100	150	70	150

\* Socket • Muffe • Manguito • Söket • υποδοχή

Δεν κατασκευάσαμε ένα νέο σύστημα καπνοδόχου, το βελτιώσαμε !

# INTERNAL CONCENTRIC AIR-GAS FLUE SYSTEM

**LIK**

KONZENTRISCHES LUFT-ABGASSYSTEM

**PPH/PPH – white**

SISTEMA DE EVACUACIÓN CONCÉNTRICO PARA EL INTERIOR

PPH/PPH – weiss

DAHILI KONSANTRIK HAVA-GAZ BACA SISTEMI

PPH/PPH – blanco

ΟΜΟΚΕΝΤΡΙΚΟ ΣΥΣΤΗΜΑ ΚΑΠΝΟΔΟΧΟΥ ΕΣΩΤΕΡΙΚΗΣ ΧΡΗΣΗΣ

PPH/PPH – beyaz

PPH/PPH – λευκό

## Ø60/100 – 80/125 mm

### LIK Boiler adapter w. 2 test plugs

LIK Messstück reduziert • LIK Adapt. cald. con 2 tm./muestras • LIK Kazan adaptörü w. 2 test fişi • LIK Συστολή λέβητα με 2 σημεία μέτρησης

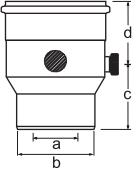
		* socket 60/100	Ø	Code Código	Kod Κωδ.	a (mm)	b (mm)	c (mm)	d (mm)
			63/96	LPMK51		63	96	65	120
			70/110	LPMK52		70	110	95	150
			80/110	LPMK53		80	110	95	150
			80/126	LPMK54		80	126	75	150
			60/100	LPMK81		60	100	110	75
		* socket 80/125	60/100	LPMK81-LET		60	100	110	75
			63/96	LPMK82		63	96	110	75
			70/100	LPMK83		70	110	85	75
			80/110	LPMK84		80	110	85	75
			80/126	LPMK85		80	126	85	75
			80/130	LPMK86		80	130	85	75

### LIK Boiler adapter eccentric

LIK Kesselanschluss exzentrisch • LIK Adapt. caldera excéntrico • LIK Kazan adaptörü eksantrik • LIK Συστολή λέβητα - έκκεντρη

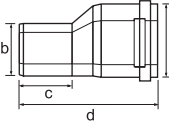
		* socket 80/125	Ø	Code Código	Kod Κωδ.	a (mm)	b (mm)	c (mm)	d (mm)
			60/100	LPXK58		130	96	73	160
			-	-		-	-	-	-
			-	-		-	-	-	-
			-	-		-	-	-	-
			-	-		-	-	-	-
			-	-		-	-	-	-

### LIK Boiler Adapter-Tee with test plug (reduced)

LIK Umlenk-T m. MÖ (reduziert) • LIK Te-Adapt. cald. con tm./muestras (reducida) • LIK Kazan Adaptörü-Tee test tapalı (azaltılmış) • LIK Ταφ με θυρίδα επιθεώρησης και σημείο μέτρησης (συστολικό)

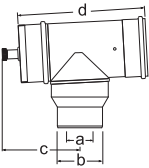
		* socket 60/100	Ø	Code Código	Kod Κωδ.	a (mm)	b (mm)	c (mm)	d (mm)
			63/96	LPTK51		63	96	165	290
			70/110	LPTK52		70	110	165	290
			80/110	LPTK53		80	110	165	290
			80/126	LPTK54		80	126	165	290
			60/98	LPTK80		60	98	165	290
		* socket 80/125	60/100	LPTK81		60	100	190	340
			60/100	LPTK81-LET		60	100	190	340
			63/96	LPTK82		63	96	190	340
			70/110	LPTK83		70	110	190	340
			80/110	LPTK84		80	110	190	340
			80/126	LPTK85		80	126	190	340
			80/130	LPTK86		80	130	190	340

\* Socket • Muffe • Manguito • Soket • υποδοχή



# INTERNAL CONCENTRIC AIR-GAS FLUE SYSTEM

LIL

KONZENTRISCHES LUFT-ABGASSYSTEM

SISTEMA DE EVACUACIÓN CONCÉNTRICO PARA EL INTERIOR

EŞ MERKEZLİ KAPALI BACA SİSTEMİ

ΟΜΟΚΕΝΤΡΙΚΟ ΣΥΣΤΗΜΑ ΚΑΠΝΟΔΟΧΟΥ ΕΣΩΤΕΡΙΚΗΣ ΧΡΗΣΗΣ

**Ø60/100 – 200/300 mm**

PPH/stainless steel – white powder coated

PPH/Edelstahl weiss pulverbeschichtet

PPH/acero inoxidable en epoxi blanco

PPH/paslanmaz çelik - beyaz toz boyalı

PPH/χάλυβας - λευκή ηλεκτροστατική βαφή

1	LPW2L5
2	LPRL05
3	LPSL25
4	LPRTL5
5	LPUL05
6	LPML56

## LIL

Ø (mm)	Inner dimension of socket Innenmass des Rohres Dimensión interior del tubo Soketin iç boyutu Εσωτερική διατομή υποδοχής (mm)	Wall thickness Wandstärke Espesor de pared Duvur kalınlığı Πάχος τοιχώματος (mm)	Outer dimension of socket Ausssenmass der Muffe Dimensión exterior del manguito Soketin dış kesiti Εξωτερική διατομή υποδοχής (mm)
60/100	102,0	0,6	113,2
80/125	128,0	0,6	139,2
110/160	163,0	0,6	176,2
125/150	181,2	0,6	182,4
160/225	227,2	0,6	228,4
200/300	302,2	0,6	303,4

LIL

**When assembling horizontal piping, it is necessary to create a slope towards the boiler at minimum of 3°.**

Gefälle schaffen waagerechte Verbindungsleitung muss zum Kessel immer ein Gefälle von mindestens 3° haben.

Al montar las tuberías horizontales, es necesario crear una pendiente hacia la caldera de un mínimo de 3°.

Yatay boru tesisatını monte ederken aşağıdakileri yapmak gerekir Kazana doğru en az 3°'lik bir eğim oluşturun.

Κατά την εγκατάσταση οριζόντιων σωληνώσεων, πρέπει να υπάρχει κλίση προς τον λέβητα τουλάχιστον 3°.

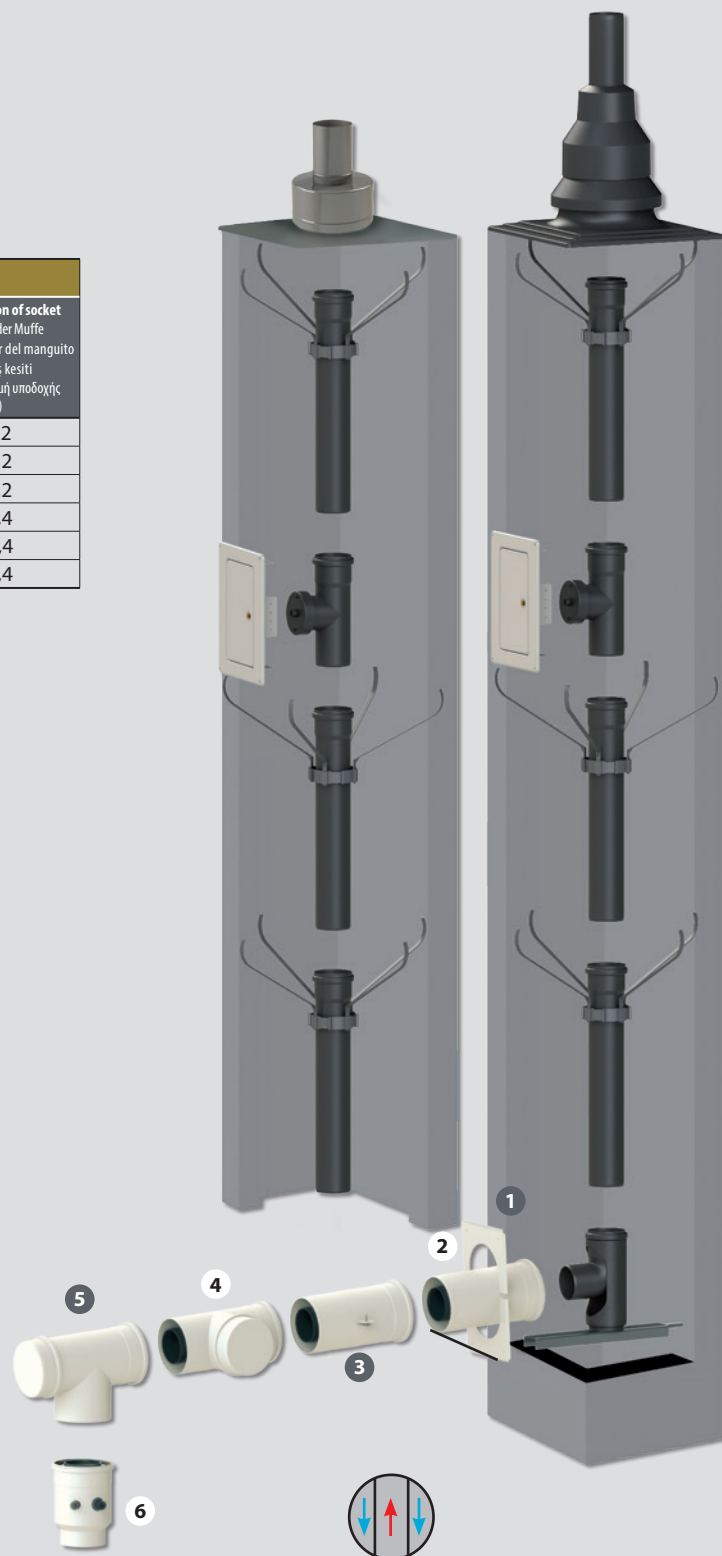

# INTERNAL CONCENTRIC AIR-GAS FLUE SYSTEM

LIL

KONZENTRISCHES LUFT-ABGASSYSTEM

SISTEMA DE EVACUACIÓN CONCÉNTRICO PARA EL INTERIOR

ΕΣ ΜΕΡΚΕΖΛΙ ΚΑΡΑΛΙ ΒΑΚΑ ΣΙΣΤΕΜΙ

ΟΜΟΚΕΝΤΡΙΚΟ ΣΥΣΤΗΜΑ ΚΑΠΝΟΔΟΧΟΥ ΕΣΩΤΕΡΙΚΗΣ ΧΡΗΣΗΣ

**Ø60/100 – 200/300 mm**

PPH/stainless steel – white powder coated

PPH/Edelstahl weiss pulverbeschichtet

PPH/acero inoxidable en epoxi blanco

PPH/paslanmaz çelik - beyaz toz boyalı

PPH/ χάλυβας - λευκή ηλεκτροστατική βαφή



## 3 Variants of appliance connection

Kesselanschlüsse in 3 Varianten

3 Variantes de aplicación

3 Cihaz bağlantısı çeşitleri

3 παραλλαγές σύνδεσης συσκευών

Variant I		Variant II		Variant III	
Variante I	Varyant I	Variante II	Varyant II	Variante III	Varyant III
Variante I	Παραλλαγή I	Variante II	Παραλλαγή II	Variante III	Παραλλαγή III
					
<b>LIL Boiler adapter</b>		<b>LIL Boiler adapter with 2 test plugs</b>		<b>LIL Tee with inspection door with test plug (reduced)</b>	
LIL Kesseladapter	LIL Kazan adaptörü	LIL Messstück reduziert	LIL 2 test fişli kazan adaptörü	LIL Umlenk-T m. MÖ (reduziert)	LIL Kontrol kapılı Tee
LIL Adaptador a caldera	LIL συστολή λέβητα	LIL Adapt. caldera con 2 tm./muestras	LIL συστολή λέβητα με σημείο μέτρησης	LIL Adapt. caldera con 2 tm./muestras	LIL Ταφ σύνδεσης λέβητα με σημείο μέτρησης (συστολικό)
<b>Ø</b> (combustion gas piping) (Abgasleitung) (tubos combustión humos) (yanma gazı boru tesisatı) (σωλήνες καυσαερίων)	<b>Ø</b> (socket of the appliance) (Kesselstutzen) (aplicación a caldera) (cihazın soketi) (υποδοχή συσκευής)	<b>Ø</b> (combustion gas piping) (Abgasleitung) (tubos combustión humos) (yanma gazı boru tesisatı) (σωλήνες καυσαερίων)	<b>Ø</b> (socket of the appliance) (Kesselstutzen) (aplicación a caldera) (cihazın soketi) (υποδοχή συσκευής)	<b>Ø</b> (combustion gas piping) (Abgasleitung) (tubos combustión humos) (yanma gazı boru tesisatı) (σωλήνες καυσαερίων)	<b>Ø</b> (socket of the appliance) (Kesselstutzen) (aplicación a caldera) (cihazın soketi) (υποδοχή συσκευής)
60/100 80/125 110/160 125/180 160/225 200/300	60/100 63/96 70/100 70/110 80/110 80/122 80/125 80/126 80/130 100/150 110/160 125/180 160/225	60/100 80/125 110/160 125/180 160/225 200/300	60/100 63/96 70/110 80/110 80/125 80/126 80/130 100/150 110/160 125/180 160/225	60/100 80/125 110/160 125/180 160/225 200/300	60/100 63/96 70/110 80/110 80/125 80/126 80/130 100/150 110/160 125/180 160/225

LPML56	LPML56-LET
	
	a = 30 mm
<p><b>LET – components are used as adapter for socket on boiler</b></p> <p>LET – Komponenten werden als Kesseladapter verwendet</p> <p>LET – Estos componentes se utilizan como adaptador a caldera</p> <p>LET – bileşenler kazan üzerindeki soket için adaptör olarak kullanılır</p> <p>LET – Εξάρτημα σύνδεσης λέβητα</p>	

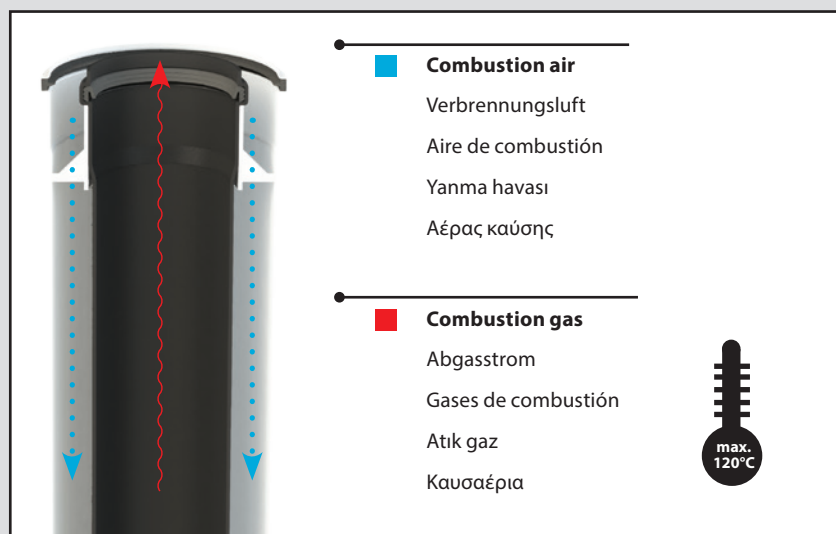

# INTERNAL CONCENTRIC AIR-GAS FLUE SYSTEM

**LIB**

KONZENTRISCHES LUFT-ABGASSYSTEM

SISTEMA DE EVACUACIÓN CONCÉNTRICO PARA EL INTERIOR

EŞ MERKEZLİ KAPALI BACA SİSTEMİ

ΟΜΟΚΕΝΤΡΙΚΟ ΣΥΣΤΗΜΑ ΚΑΠΝΟΔΟΧΟΥ ΕΣΩΤΕΡΙΚΗΣ ΧΡΗΣΗΣ

**Ø60/100 – 200/300 mm**

**PPH/stainless steel – polished**

PPH/Edelstahl hochglanz

PPH/acero inoxidable pulido

LIB - PPH/paslanmaz çelik - cilalı

PPH/ανοξειδωτος χάλυβας

1	LPW2B5
2	LPRB05
3	LPSB25
4	LPRTB5
5	LPUB05
6	LPMB56

LIB			
Ø (mm)	Inner dimension of socket Innenmass des Rohres Dimensión interior del tubo Soketin iç boyutu Εσωτερική διατομή υποδοχής (mm)	Wall thickness Wandstärke Espesor de pared Duvar kalınlığı Πάχος τοιχώματος (mm)	Outer dimension of socket Aussemass der Muffe Dimensión exterior del manguito Soketin dış kesiti Εξωτερική διατομή υποδοχής (mm)
60/100	102,0	0,6	113,2
80/125	128,0	0,6	139,2
110/160	163,0	0,6	176,2
125/150	181,2	0,6	182,4
160/225	227,2	0,6	228,4
200/300	302,2	0,6	303,4

**LIB**

**When assembling horizontal piping, it is necessary to create a slope towards the boiler at minimum of 3°.**

Gefälle schaffen waagerechte Verbindungsleitung muss zum Kessel immer ein Gefälle von mindestens 3° haben.

Al montar las tuberías horizontales, es necesario crear una pendiente hacia la caldera de un mínimo de 3°.

Yatay boru tesisatını monte ederken aşağıdakileri yapmak gerekir Kazana doğru en az 3°'lik bir eğim oluşturun.

Κατά την εγκατάσταση οριζόντιων σωληνώσεων, πρέπει να υπάρχει κλίση προς τον λέβητα τουλάχιστον 3°.

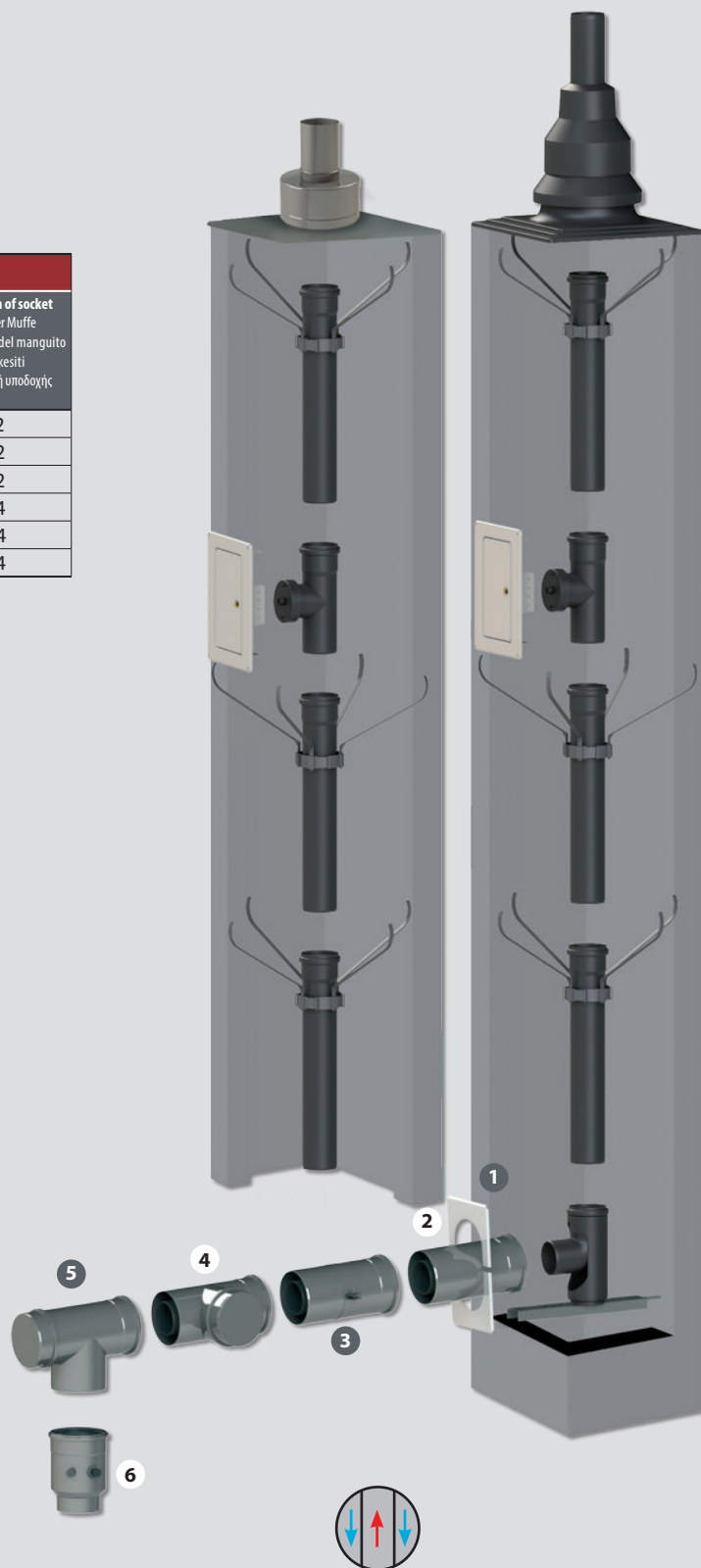

# INTERNAL CONCENTRIC AIR-GAS FLUE SYSTEM

**LIB**

KONZENTRISCHES LUFT-ABGASSYSTEM

PPH/stainless steel – polished

SISTEMA DE EVACUACIÓN CONCÉNTRICO PARA EL INTERIOR

PPH/Edelstahl hochglanz

EŞ MERKEZLİ KAPALI BACA SİSTEMİ



PPH/acero inoxidable pulido

ΟΜΟΚΕΝΤΡΙΚΟ ΣΥΣΤΗΜΑ ΚΑΠΝΟΔΟΧΟΥ ΕΣΩΤΕΡΙΚΗΣ ΧΡΗΣΗΣ

LIB - PPH/paslanmaz çelik - cilalı

PPH/ανοξειδωτος χάλυβας

**Ø60/100 – 200/300 mm**

3 Variants of appliance connection					
Kesselanschlüsse in 3 Varianten 3 Variantes de aplicación		3 Cihaz bağlantısı çeşitleri 3 παραλλαγές σύνδεσης συσκευών			
Variant I		Variant II		Variant III	
Variante I	Varyant I	Variante II	Varyant II	Variante III	Varyant III
Variante I	Παραλλαγή I	Variante II	Παραλλαγή II	Variante III	Παραλλαγή III
					
LIB Boiler adapter		LIB Boiler adapter with 2 test plugs		LIB Tee with inspection door with test plug (reduced)	
LIB Kesseladapter	LIB Kazan adaptörü	LIB Messstück reduziert	LIB 2 test fişli kazan adaptörü	LIB Umlenk-T m. MÖ (reduziert)	LIB Kontrol kapılı Tee
LIB Adaptador a caldera	LIB συστολή λέβητα	LIB Adapt. caldera con 2 tm./muestras	LIB συστολή λέβητα με σημείο μέτρησης	LIB Te-Adapt. cald. con tm./muestras	LIB Ταφ σύνδεσης λέβητα με σημείο μέτρησης (συστολικό)
<b>Ø</b> (combustion gas piping) (Abgasleitung) (tubos combustión humos) (yanma gazı boru tesisatı) (σωλήνες καυσαερίων)	<b>Ø</b> (socket of the appliance) (Kesselstutzen) (aplicación a caldera) (cihazın soketi) (υποδοχή συσκευής)	<b>Ø</b> (combustion gas piping) (Abgasleitung) (tubos combustión humos) (yanma gazı boru tesisatı) (σωλήνες καυσαερίων)	<b>Ø</b> (socket of the appliance) (Kesselstutzen) (aplicación a caldera) (cihazın soketi) (υποδοχή συσκευής)	<b>Ø</b> (combustion gas piping) (Abgasleitung) (tubos combustión humos) (yanma gazı boru tesisatı) (σωλήνες καυσαερίων)	<b>Ø</b> (socket of the appliance) (Kesselstutzen) (aplicación a caldera) (cihazın soketi) (υποδοχή συσκευής)
60/100 80/125 110/160 125/180 160/225 200/300	60/100 63/96 70/100 70/110 80/110 80/122 80/125 80/126 80/130 100/150 110/160 125/180 160/225	60/100 80/125 110/160 125/180 160/225 200/300	60/100 63/96 70/110 80/110 80/125 80/126 80/130 100/150 110/160 125/180 160/225	60/100 80/125 110/160 125/180 160/225 200/300	60/100 63/96 70/110 80/110 80/125 80/126 80/130 100/150 110/160 125/180 160/225

LPMB56	LPMB56-LET
	
	a = 30 mm
<p><b>LET – components are used as adapter for socket on boiler</b></p> <p>LET – Komponenten werden als Kesseladapter verwendet</p> <p>LET – Estos componentes se utilizan como adaptador a caldera</p> <p>LET – bileşenler kazan üzerindeki soket için adaptör olarak kullanılır</p> <p>LET – Εξάρτημα σύνδεσης λέβητα</p>	

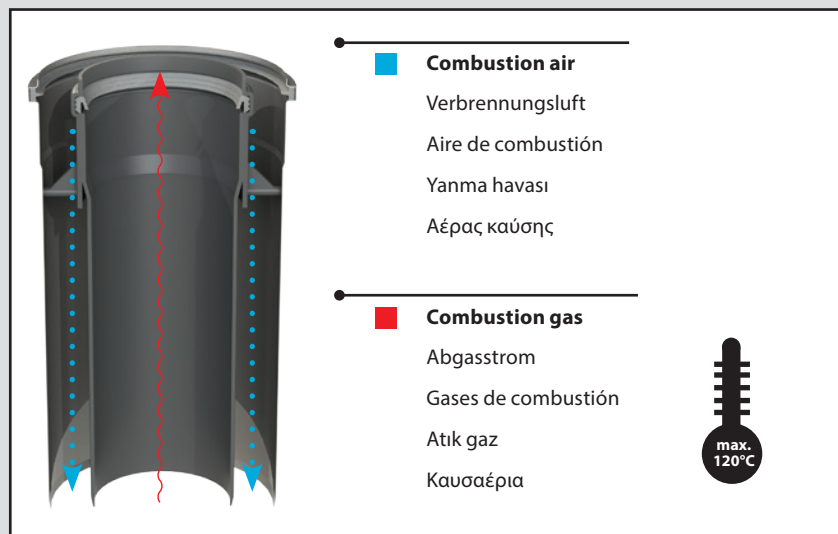

# INTERNAL CONCENTRIC AIR-GAS FLUE SYSTEM

**LIL/LIB**

KONZENTRISCHES LUFT-ABGASSYSTEM

**LIL - PPH/stainless steel – white powder coated**

SISTEMA DE EVACUACIÓN CONCÉNTRICO PARA EL INTERIOR

PPH/Edelstahl weiss pulverbeschichtet

EŞ MERKEZLİ KAPALI BACA SİSTEMİ

PPH/acero inoxidable en epoxi blanco

ΟΜΟΚΕΝΤΡΙΚΟ ΣΥΣΤΗΜΑ ΚΑΠΝΟΔΟΧΟΥ ΕΣΩΤΕΡΙΚΗΣ ΧΡΗΣΗΣ

PPH/paslanmaz çelik - beyaz toz boyalı

PPH/χάλυβας - λευκή ηλεκτροστατική βαφή

**LIB - PPH/stainless steel – polished**

PPH/Edelstahl hochglanz - PPH/acero inoxidable pulido

PPH/paslanmaz çelik - cilalı - PPH/ανοξειδωτος χάλυβας

**Ø60/100 – 200/300 mm**

## LIL/LIB Pipe with socket

LIL/LIB Rohr m. Muffe • LIL/LIB Tubo M/H • LIL/LIB Soketli boru • LIL/LIB Σωλήνα με υποδοχή (κεφάλι)

	Ø	Code Código Kod Κωδ.		a (mm)	b (mm)	c (mm)	d (mm)
		LIL	LIB				
250 mm	60/100	LPRL05	LPRB05	104	52	198	-
	80/125	LPRL08	LPRB08	130	52	198	-
	100/150	LPRL0X	-	153	52	198	-
	110/160	LPRL01	LPRB01	163	52	198	-
	125/180	LPRL02	LPRB02	182	62	188	-
	160/225	LPRL06	LPRB06	227	67	183	-
500 mm	200/300	LPRL00	LPRB00	302	67	183	-
	60/100	LPRL55	LPRB55	104	52	448	-
	80/125	LPRL58	LPRB58	130	52	448	-
	100/150	LPRL5X	-	153	52	448	-
	110/160	LPRL51	LPRB51	163	52	448	-
	125/180	LPRL52	LPRB52	182	62	438	-
1000 mm	160/225	LPRL56	LPRB56	227	67	433	-
	200/300	LPRL50	LPRB50	302	67	433	-
	60/100	LPRL15	LPRB15	104	52	948	-
	80/125	LPRL18	LPRB18	130	52	948	-
	100/150	LPRL1X	-	153	52	948	-
	110/160	LPRL11	LPRB11	163	52	948	-
	125/180	LPRL12	LPRB12	182	62	938	-
	160/225	LPRL16	LPRB16	227	67	933	-
	200/300	LPRL10	LPRB10	302	67	933	-

## LIL/LIB Adjustable pipe with clamp

LIL/LIB Schieberohr • LIL/LIB Tubo extensible • LIL/LIB Keleperçeli ayarlanabilir boru • LIL/LIB Πτυσσόμενος σωλήνας με σφιγκτήρα

	Ø	Code Código Kod Κωδ.		a (mm)	b (mm)	c (mm)	d (mm)
		LIL	LIB				
230 – 290 mm	60/100	LPSL25	LPSB25	104	52	180	310
	80/125	LPSL28	LPSB28	130	52	180	310
	100/150	LPSL2X	-	153	52	180	310
	110/160	LPSL21	LPSB21	163	52	180	310
	125/180	LPSL22	LPSB22	180	62	190	310
	160/225	LPSL26	LPSB26	225	67	195	310
320 – 560 mm	200/300	LPSL20	LPSB20	300	67	195	310
	60/100	LPSL55	LPSB55	104	52	330	610
	80/125	LPSL58	LPSB58	130	52	330	610
	100/150	LPSL5X	-	153	52	330	610
	110/160	LPSL51	LPSB51	163	52	330	610
	125/180	LPSL52	LPSB52	180	62	340	610
	160/225	LPSL56	LPSB56	225	67	345	610
	200/300	LPSL50	LPSB50	300	67	345	610

## LIL/LIB Inspection-Tee

LIL/LIB Revisions-T • LIL/LIB Te-Inspección • LIL/LIB Muayene - Tee • LIL/LIB Ταφ με θυρίδα επιθεώρησης

	Ø	Code Código Kod Κωδ.		a (mm)	b (mm)	c (mm)	d (mm)
		LIL	LIB				
LIL LIB	60/100	LPRTL5	LPRTB5	104	52	230	142
	80/125	LPRTL8	LPRTB8	130	52	270	142
	100/150	LPRTLX	-	153	52	330	152
	110/160	LPRTL1	LPRTB1	163	52	330	152
	125/180	LPRTL2	LPRTB2	182	62	320	150
	160/225	LPRTL6	LPRTB6	227	67	350	170
	200/300	LPRTL0	LPRTB0	302	67	430	200

# INTERNAL CONCENTRIC AIR-GAS FLUE SYSTEM

**LIL/LIB**

KONZENTRISCHES LUFT-ABGASSYSTEM

**LIL - PPH/stainless steel – white powder coated**

SISTEMA DE EVACUACIÓN CONCÉNTRICO PARA EL INTERIOR

PPH/Edelstahl weiss pulverbeschichtet

EŞ MERKEZLİ KAPALI BACA SİSTEMİ

PPH/acero inoxidable en epoxi blanco

ΟΜΟΚΕΝΤΡΙΚΟ ΣΥΣΤΗΜΑ ΚΑΠΝΟΔΟΧΟΥ ΕΣΩΤΕΡΙΚΗΣ ΧΡΗΣΗΣ

PPH/paslanmaz çelik - beyaz toz boyalı

PPH/χάλυβας - λευκή ηλεκτροστατική βαφή

**LIB - PPH/stainless steel – polished**

PPH/Edelstahl hochglanz · PPH/acero inoxidable pulido

PPH/paslanmaz çelik - cilalı · PPH/ανοξειδωτος χάλυβας

**Ø60/100 – 200/300 mm**

## LIL/LIB Inspection-Tee w. test plug

LIL/LIB Revisions-T m. MÖ • LIL/LIB Te-Inspección c. tm./muestras • LIL/LIB Muayene-Tee w. test tapası • LIL/LIB Ταφ με θυρίδα επιθεώρησης και σημείο μέτρησης

Ø	Code Código Kod Κωδ.		a (mm)	b (mm)	c (mm)	d (mm)
	LIL	LIB				
60/100	LPRML5	LPRMB5	104	52	230	175
80/125	LPRML8	LPRMB8	130	52	270	180
100/150	LPRMLX	-	153	52	330	210
110/160	LPRML1	LPRMB1	163	52	330	210
125/180	LPRML2	LPRMB2	182	62	350	190
160/225	LPRML6	LPRMB6	227	67	350	210
200/300	LPRML0	LPRMB0	302	67	430	240

## LIL/LIB Deflection-Tee w. inspection

LIL/LIB Umlenk-T m. Rev.-Deckel • LIL/LIB Te-Desvío con inspección • LIL/LIB Sapma-Tee w. denetimi • LIL/LIB Ταφ με θυρίδα επιθεώρησης με αλλαγή κατεύθυνσης

Ø	Code Código Kod Κωδ.		a (mm)	b (mm)	c (mm)	d (mm)
	LIL	LIB				
60/100	LPUL05	LPUB05	104	52	250	125
60/100	LPUL05-LET	-	104	52	250	125
80/125	LPUL08	LPUB08	130	52	290	140
100/150	LPUL0X	-	153	52	335	170
110/160	LPUL01	LPUB01	163	52	335	170
125/180	LPUL02	LPUB02	182	62	320	185
160/225	LPUL06	LPUB06	227	67	360	215
200/300	LPUL00	LPUB00	302	67	435	255

## LIL/LIB Deflection-Tee with test plug

LIL/LIB Umlenk-T m. MÖ • LIL/LIB Te-Desvío con tm./muestras • LIL/LIB Test tapalı Sapma T'si • LIL/LIB Ταφ με θυρίδα επιθεώρησης με αλλαγή κατεύθυνσης και σημείο μέτρησης

Ø	Code Código Kod Κωδ.		a (mm)	b (mm)	c (mm)	d (mm)
	LIL	LIB				
60/100	LPUML5	LPUMB5	104	52	238	165
80/125	LPUML8	LPUMB8	130	52	288	190
100/150	LPUMLX	-	153	52	323	210
110/160	LPUML1	LPUMB1	163	52	323	210
125/180	LPUML2	LPUMB2	182	62	320	225
160/225	LPUML6	LPUMB6	227	67	360	255
200/300	LPUML0	LPUMB0	302	67	435	305

## LIL/LIB Drain-Tee (horizontal)

LIL/LIB Ablauf-T horizontal • LIL/LIB Te-Desc./condensados horizontal • LIL/LIB Drenaj -Tee (yatay) • LIL/LIB Ταφ με θυρίδα επιθεώρησης και αποστράγγιση

Ø	Code Código Kod Κωδ.		a (mm)	b (mm)	c (mm)	d (mm)
	LIL	LIB				
60/100	LPRLA5	LPRBA5	104	52	178	185
80/125	LPRLA8	LPRBA8	130	52	218	190
100/150	LPRLAX	-	153	52	278	220
110/160	LPRLA1	LPRBA1	163	52	278	220
125/180	LPRLA2	LPRBA2	182	62	320	200
160/225	LPRLA6	LPRBA6	227	67	360	220
200/300	LPRLA0	LPRBA0	302	67	435	250

## LIL/LIB Deflection-Tee with drain

LIL/LIB Umlenk-T m. Ablauf • LIL/LIB Te-Desvío con desc./cond. • LIL/LIB Drenajlı Saptırma Keçesi • LIL/LIB Ταφ με θυρίδα επιθεώρησης με αποστράγγιση και αλλαγή κατεύθυνσης

Ø	Code Código Kod Κωδ.		a (mm)	b (mm)	c (mm)	d (mm)
	LIL	LIB				
60/100	LPULA5	LPUBA5	104	52	238	165
80/125	LPULA8	LPUBA8	130	52	288	190
100/150	LPULAX	-	153	52	323	210
110/160	LPULA1	LPUBA1	163	52	323	210
125/180	LPULA2	LPUBA2	182	62	320	235
160/225	LPULA6	LPUBA6	227	67	360	265
200/300	LPULA0	LPUBA0	302	67	435	315

# INTERNAL CONCENTRIC AIR-GAS FLUE SYSTEM

**LIL/LIB**

KONZENTRISCHES LUFT-ABGASSYSTEM

**LIL - PPH/stainless steel - white powder coated**

SISTEMA DE EVACUACIÓN CONCÉNTRICO PARA EL INTERIOR

PPH/Edelstahl weiss pulverbeschichtet

EŞ MERKEZLİ KAPALI BACA SİSTEMİ

PPH/acero inoxidable en epoxi blanco

ΟΜΟΚΕΝΤΡΙΚΟ ΣΥΣΤΗΜΑ ΚΑΠΝΟΔΟΧΟΥ ΕΣΩΤΕΡΙΚΗΣ ΧΡΗΣΗΣ

PPH/paslanmaz çelik - beyaz toz boyalı

PPH/χάλυβας - λευκή ηλεκτροστατική βαφή

**LIB - PPH/stainless steel - polished**

PPH/Edelstahl hochglanz · PPH/acero inoxidable pulido

PPH/paslanmaz çelik - cilalı · PPH/ανοξειδωτός χάλυβας

**Ø60/100 – 200/300 mm**

## LIL/LIB Connecting-Tee

LIL/LIB Verbindungs-T • LIL/LIB Te-Empalme • LIL/LIB Bağlama - Tee • LIL/LIB Ταφ σύνδεσης

Ø	Code Código Kod Κωδ.		a (mm)	b (mm)	c (mm)	d (mm)
	LIL	LIB				
60/100	LPVTL5	LPVTB5	104	52	250	125
80/125	LPVTL8	LPVTB8	130	52	290	140
100/150	LPVTLX	-	153	52	335	170
110/160	LPVTL1	LPVTB1	163	52	335	170
125/180	LPVTL2	LPVTB2	182	62	320	150
160/225	LPVTL6	LPVTB6	227	67	360	215
200/300	LPVTL0	LPVTB0	302	67	435	255

## LIL/LIB Elbow 15°

LIL/LIB Bogen 15° • LIL/LIB Codo 15° • LIL/LIB Dirsek 15° • LIL/LIB Καμπύλη 15°

Ø	Code Código Kod Κωδ.		a (mm)	b (mm)	c (mm)	d (mm)
	LIL	LIB				
60/100	LPBL15	LPBB15	104	52	87	65
80/125	LPBL18	LPBB18	130	52	82	65
100/150	LPBL1X	-	153	52	82	70
110/160	LPBL11	LPBB11	163	52	82	70
125/180	LPBL12	LPBB12	182	62	105	115
160/225	LPBL16	LPBB16	227	67	145	155
200/300	LPBL10	LPBB10	302	67	165	185

## LIL/LIB Elbow 30°

LIL/LIB Bogen 30° • LIL/LIB Codo 30° • LIL/LIB Dirsek 30° • LIL/LIB Καμπύλη 30°

Ø	Code Código Kod Κωδ.		a (mm)	b (mm)	c (mm)	d (mm)
	LIL	LIB				
60/100	LPBL35	LPBB35	104	52	92	78
80/125	LPBL38	LPBB38	130	52	97	85
100/150	LPBL3X	-	153	52	102	90
110/160	LPBL31	LPBB31	163	52	102	90
125/180	LPBL32	LPBB32	182	62	145	150
160/225	LPBL36	LPBB36	227	67	165	165
200/300	LPBL30	LPBB30	302	67	185	195

## LIL/LIB Elbow 45°

LIL/LIB Bogen 45° • LIL/LIB Codo 45° • LIL/LIB Dirsek 45° • LIL/LIB Καμπύλη 45°

Ø	Code Código Kod Κωδ.		a (mm)	b (mm)	c (mm)	d (mm)
	LIL	LIB				
60/100	LPBL45	LPBB45	104	52	97	95
80/125	LPBL48	LPBB48	130	52	97	80
100/150	LPBL4X	-	153	52	122	115
110/160	LPBL41	LPBB41	163	52	122	115
125/180	LPBL42	LPBB42	182	62	170	175
160/225	LPBL46	LPBB46	227	67	195	190
200/300	LPBL40	LPBB40	302	67	215	220

## LIL/LIB Elbow 87°

LIL/LIB Bogen 87° • LIL/LIB Codo 87° • LIL/LIB Dirsek 87° • LIL/LIB Καμπύλη 97°

Ø	Code Código Kod Κωδ.		a (mm)	b (mm)	c (mm)	d (mm)
	LIL	LIB				
60/100	LPBL95	LPBB95	104	52	135	123
80/125	LPBL98	LPBB98	130	52	157	135
100/150	LPBL9X	-	153	52	176	151
110/160	LPBL91	LPBB91	163	52	176	151
125/180	LPBL92	LPBB92	182	62	210	180
160/225	LPBL96	LPBB96	227	67	225	205
200/300	LPBL90	LPBB90	302	67	270	245

# INTERNAL CONCENTRIC AIR-GAS FLUE SYSTEM

**LIL/LIB**

KONZENTRISCHES LUFT-ABGASSYSTEM

LIL - PPH/stainless steel – white powder coated

SISTEMA DE EVACUACIÓN CONCÉNTRICO PARA EL INTERIOR

PPH/Edelstahl weiss pulverbeschichtet

EŞ MERKEZLİ KAPALI BACA SİSTEMİ

PPH/acero inoxidable en epoxi blanco

ΟΜΟΚΕΝΤΡΙΚΟ ΣΥΣΤΗΜΑ ΚΑΠΝΟΔΟΧΟΥ ΕΣΩΤΕΡΙΚΗΣ ΧΡΗΣΗΣ

PPH/paslanmaz çelik - beyaz toz boyalı

PPH/χάλυβας - λευκή ηλεκτροστατική βαφή

**LIB - PPH/stainless steel – polished**

PPH/Edelstahl hochglanz · PPH/acero inoxidable pulido

PPH/paslanmaz çelik - cilalı · PPH/ανοξειδωτος χάλυβας

**Ø60/100 – 200/300 mm**

## LIL/LIB Elbow 87° (short)

LIL/LIB Kurzbogen 87° • LIL/LIB Codo 87° (corto) • LIL/LIB Dirsek 87° (kısa) • LIL/LIB Καμπύλη 87° (κοντή)

Ø	Code Código Kod Κωδ.		a (mm)	b (mm)	c (mm)	d (mm)
	LIL	LIB				
60/100	LPBLK5	LPBBK5	104	52	125	95
80/125	LPBLK8	LPBBK8	130	52	130	110
100/150	LPBLKX	-	153	52	140	130
110/160	LPBLK1	LPBBK1	163	52	140	130
125/180	LPBLK2	LPBBK2	182	62	190	185
160/225	LPBLK6	LPBBK6	227	67	210	190
200/300	LPBLK0	LPBBK0	302	67	270	235

## LIL/LIB Inspection elbow 87°

LIL/LIB Revisionsbogen 87° • LIL/LIB Codo inspección 87° • LIL/LIB Dirsek 87° w. test tapası • LIL/LIB Καμπύλη 87° με θυρίδα επιθεώρησης

Ø	Code Código Kod Κωδ.		a (mm)	b (mm)	c (mm)	d (mm)
	LIL	LIB				
60/100	LPRBL5	LPRBB5	104	52	125	95
80/125	LPRBL8	LPRBB8	130	52	130	110
100/150	LPRBLX	-	153	52	140	130
110/160	LPRBL1	LPRBB1	163	52	140	130
125/180	LPRBL2	LPRBB2	182	62	185	180
160/225	LPRBL6	LPRBB6	227	67	210	190
200/300	LPRBL0	LPRBB0	302	67	260	235

## LIL/LIB Inspection elbow 87° w. test plug

LIL/LIB Rev.-Bogen 87° m. MÖ • LIL/LIB Codo inspec. 87° con tm./muestras • LIL/LIB Muayene dirseği 87° w. test tapası • LIL/LIB Καμπύλη 87° με θυρίδα επιθεώρησης και σημείο μέτρησης

Ø	Code Código Kod Κωδ.		a (mm)	b (mm)	c (mm)	d (mm)
	LIL	LIB				
60/100	LPRLM5	LPRBM5	104	52	125	95
80/125	LPRLM8	LPRBM8	130	52	130	110
100/150	LPRLMX	-	153	52	140	130
110/160	LPRLM1	LPRBM1	163	52	140	130
125/180	LPRLM2	LPRBM2	182	62	185	180
160/225	LPRLM6	LPRBM6	227	67	210	190
200/300	LPRLM0	LPRBM0	302	67	260	235

## LIL/LIB Elbow 87° w. test plug

LIL/LIB Bogen 87° m. MÖ • LIL/LIB Codo 87° con tm./muestras • LIL/LIB Dirsek 87° w. test tapası • LIL/LIB Καμπύλη 87° με σημείο μέτρησης

Ø	Code Código Kod Κωδ.		a (mm)	b (mm)	c (mm)	d (mm)
	LIL	LIB				
60/100	LPBLM5	LPBBM5	104	52	135	123
80/125	LPBLM8	LPBBM8	130	52	157	135
100/150	LPBLMX	-	153	52	176	151
110/160	LPBLM1	LPBBM1	163	52	176	151
125/180	LPBLM2	LPBBM2	182	62	210	180
160/225	LPBLM6	LPBBM6	227	67	225	205
200/300	LPBLM0	LPBBM0	302	67	270	245

## LIL/LIB Chimney support elbow 87°

LIL/LIB Stütz-Bogen 87° • LIL/LIB Codo apoyo chimenea 87° • LIL/LIB Baca destek dirseği 87° • LIL/LIB Καμπύλη στερέωσης 87°

Ø	Code Código Kod Κωδ.		a (mm)	b (mm)	c (mm)	d (mm)
	LIL	LIB				
60/100	LPSBL5	LPSBB5	104	190	81	95
80/125	LPSBL8	LPSBB8	126	160	81	110
100/150	LPSBLX	-	153	240	81	110
110/160	LPSBL1	LPSBB1	163	240	81	110
125/180	LPSBL2	LPSBB2	182	255	111	135
160/225	LPSBL6	LPSBB6	227	235	111	170
200/300	LPSBL0	LPSBB0	302	255	111	210

Δεν κατασκευάσαμε ένα νέο σύστημα καπνοδόχου, το βελτιώσαμε !

# INTERNAL CONCENTRIC AIR-GAS FLUE SYSTEM

**LIL/LIB**

KONZENTRISCHES LUFT-ABGASSYSTEM

LIL - PPH/stainless steel - white powder coated

SISTEMA DE EVACUACIÓN CONCÉNTRICO PARA EL INTERIOR

PPH/Edelstahl weiss pulverbeschichtet

EŞ MERKEZLİ KAPALI BACA SİSTEMİ

PPH/acero inoxidable en epoxi blanco

ΟΜΟΚΕΝΤΡΙΚΟ ΣΥΣΤΗΜΑ ΚΑΠΝΟΔΟΧΟΥ ΕΣΩΤΕΡΙΚΗΣ ΧΡΗΣΗΣ

PPH/paslanmaz çelik - beyaz toz boyalı

PPH/χάλυβας - λευκή ηλεκτροστατική βαφή

**LIB - PPH/stainless steel - polished**

PPH/Edelstahl hochglanz - PPH/acero inoxidable pulido

PPH/paslanmaz çelik - cilalı - PPH/ανοξειδωτος χάλυβας

**Ø60/100 - 200/300 mm**

## LIL/LIB Condensation trap

LIL/LIB Kondensatfalle • LIL/LIB Descarga condensados • LIL/LIB Yoğuşma kapanı • LIL/LIB Παγίδα συμκνωμάτων

Ø	Code Código Kod Κωδ.		a (mm)	b (mm)	c (mm)	d (mm)
	LIL	LIB				
60/100	LPKFL5	LPKFB5	104	80	80	100
80/125	LPKFL8	LPKFB8	130	82	80	130
100/150	LPKFLX	-	153	82	80	150
110/160	LPKFL1	LPKFB1	163	82	80	150
125/180	LPKFL2	LPKFB2	-	-	-	-
160/225	LPKFL6	LPKFB6	-	-	-	-
200/300	LPKFL0	LPKFB0	-	-	-	-

## LIL/LIB Measuring piece with 2 test plugs

LIL/LIB Messstück m. 2 Messöffnungen • LIL/LIB Tramo con 2 tm./muestras • LIL/LIB 2 test fişli ölçüm parçası • LIL/LIB Εξάρτημα με 2 σημεία μέτρησης

Ø	Code Código Kod Κωδ.		a (mm)	b (mm)	c (mm)	d (mm)
	LIL	LIB				
60/100	LPMSL5	LPMSB5	104	52	105	80
80/125	LPMSL8	LPMSB8	130	52	105	80
100/150	LPMSLX	-	153	52	105	80
110/160	LPMSL1	LPMSB1	163	52	105	80
125/180	LPMSL2	LPMSB2	182	80	185	80
160/225	LPMSL6	LPMSB6	227	80	185	80
200/300	LPMSL0	LPMSB0	302	80	185	80

## LIL/LIB Shaft connection with wall cover

LIL/LIB Schachtanschluss • LIL/LIB Pasamuros con remate • LIL/LIB Duvar kapaklı shaft bağlantısı • LIL/LIB Σωλήνας με ροζέτα

Ø	Code Código Kod Κωδ.		a (mm)	b (mm)	c (mm)	d (mm)
	LIL	LIB				
60/100	LPSAL5	LPSAB5	175	50	45	-
80/125	LPSAL8	LPSAB8	175	50	45	-
100/150	LPSALX	-	175	50	45	-
110/160	LPSAL1	LPSAB1	175	50	45	-
125/180	LPSAL2	LPSAB2	-	-	-	-
160/225	LPSAL6	LPSAB6	-	-	-	-
200/300	LPSAL0	LPSAB0	-	-	-	-

## LIL/LIB Tee for air supply

LIL/LIB Zuluft-T • LIL/LIB Te con entrada de aire • LIL/LIB Hava beslemesi için Tee • LIL/LIB Ταφ για παροχή αέρα

Ø	Code Código Kod Κωδ.		a (mm)	b (mm)	c (mm)	d (mm)
	LIL	LIB				
60/100	LPZTL5	LPZTB5	140	80	100	260
80/125	LPZTL8	LPZTB8	190	113	113	298
100/150	LPZTLX	-	190	105	130	340
110/160	LPZTL1	LPZTB1	190	105	130	340
125/180	LPZTL2	LPZTB2	210	110	142	370
160/225	LPZTL6	LPZTB6	240	130	173	405
200/300	LPZTL0	LPZTB0	300	163	216	525

## LIL/LIB Air intake protection

LIL/LIB Luftansaugschutz • LIL/LIB Protector entrada de aire • LIL/LIB Hava girişi koruması • LIL/LIB Προστατευτικό εισαγωγής αέρα καύσης

Ø	Code Código Kod Κωδ.		a (mm)	b (mm)	c (mm)	d (mm)
	LIL	LIB				
60/100	LPAKL5	LPAKB5	100	60	95	-
80/125	LPAKL8	LPAKB8	126	80	95	-
100/150	LPAKLX	-	150	100	95	-
110/160	LPAKL1	LPAKB1	160	110	95	-
125/180	LPAKL2	LPAKB2	180	125	95	-
160/225	LPAKL6	LPAKB6	225	160	95	-
200/300	LPAKL0	LPAKB0	-	-	-	-

# INTERNAL CONCENTRIC AIR-GAS FLUE SYSTEM

**LIL/LIB**

KONZENTRISCHES LUFT-ABGASSYSTEM

LIL - PPH/stainless steel – white powder coated

SISTEMA DE EVACUACIÓN CONCÉNTRICO PARA EL INTERIOR

PPH/Edelstahl weiss pulverbeschichtet

EŞ MERKEZLİ KAPALI BACA SİSTEMİ

PPH/acero inoxidable en epoxi blanco

ΟΜΟΚΕΝΤΡΙΚΟ ΣΥΣΤΗΜΑ ΚΑΠΝΟΔΟΧΟΥ ΕΣΩΤΕΡΙΚΗΣ ΧΡΗΣΗΣ

PPH/paslanmaz çelik - beyaz toz boyalı

PPH/χάλυβας - λευκή ηλεκτροστατική βαφή

**LIB - PPH/stainless steel – polished**

PPH/Edelstahl hochglanz · PPH/acero inoxidable pulido

PPH/paslanmaz çelik - cilalı · PPH/ανοξειδωτος χάλυβας

**Ø60/100 – 200/300 mm**

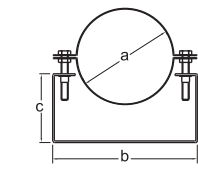
<b>LIL/LIB Wall bracket</b>		LIL/LIB Decken-Wandhalterung · LIL/LIB Anclaje mural · LIL/LIB Duvar braketı · LIL/LIB Στήριγμα τοίχου						
		Ø	Code Código Kod Κωδ.		a (mm)	b (mm)	c (mm)	d (mm)
			LIL	LIB				
		60/100	LPWHL5	LPWHB5	100	165	90	-
		80/125	LPWHL8	LPWHB8	125	190	90	-
		100/150	LPWHLX	-	150	220	115	-
		110/160	LPWHL1	LPWHB1	160	220	115	-
		125/180	LPWHL2	LPWHB2	180	245	140	-
		160/225	LPWHL6	LPWHB6	225	285	157	-
		200/300	LPWHL0	LPWHB0	300	360	200	-

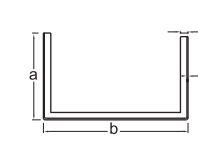

<b>LIL/LIB Wall bracket extension I</b>		LIL/LIB Wandhalter Verlängerung I · LIL/LIB Extensión anclaje mural I · LIL/LIB Duvar braketı uzatması I · LIL/LIB Προέκταση στηρίγματος τοίχου I						
		Ø	Code Código Kod Κωδ.		a (mm)	b (mm)	c (mm)	d (mm)
			LIL	LIB				
		60/100	LPV1L5	LPV1B5	100	165	10	2
		80/125	LPV1L8	LPV1B8	100	185	10	2
		100/150	LPV1LX	-	100	230	10	2
		110/160	LPV1L1	LPV1B1	100	230	10	2
		125/180	LPV1L2	LPV1B2	100	245	10	2
		160/225	LPV1L6	LPV1B6	100	285	10	2
		200/300	LPV1L0	LPV1B0	100	360	10	2

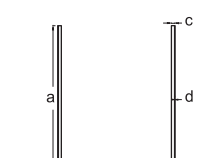

<b>LIL/LIB Wall bracket extension II</b>		LIL/LIB Wandhalter Verlängerung II · LIL/LIB Extensión anclaje mural II · LIL/LIB Duvar braketı uzatması II · LIL/LIB Προέκταση στηρίγματος τοίχου II						
		Ø	Code Código Kod Κωδ.		a (mm)	b (mm)	c (mm)	d (mm)
			LIL	LIB				
		60/100	LPV2L5	LPV2B5	250	165	10	2
		80/125	LPV2L8	LPV2B8	250	185	10	2
		100/150	LPV2LX	-	250	230	10	2
		110/160	LPV2L1	LPV2B1	250	230	10	2
		125/180	LPV2L2	LPV2B2	250	245	10	2
		160/225	LPV2L6	LPV2B6	250	285	10	2
		200/300	LPV2L0	LPV2B0	250	360	10	2

<b>LIL/LIB Wall bracket extension III</b>		LIL/LIB Wandhalter Verlängerung III · LIL/LIB Extensión anclaje mural III · LIL/LIB Duvar braketı uzatması III · LIL/LIB Προέκταση στηρίγματος τοίχου III						
		Ø	Code Código Kod Κωδ.		a (mm)	b (mm)	c (mm)	d (mm)
			LIL	LIB				
		60/100	LPV3L5	LPV3B5	335	165	10	2
		80/125	LPV3L8	LPV3B8	335	185	10	2
		100/150	LPV3LX	-	335	230	10	2
		110/160	LPV3L1	LPV3B1	335	230	10	2
		125/180	LPV3L2	LPV3B2	335	245	10	2
		160/225	LPV3L6	LPV3B6	335	285	10	2
		200/300	LPV3L0	LPV3B0	335	360	10	2

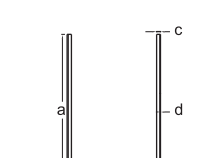
<b>ZUB Wall rose</b>		ZUB Wandrosette · ZUB Junta tapamuros · ZUB Duvar gülü · ZUB Ποζέτα						
		Ø	Code Código Kod Κωδ.		a (mm)	b (mm)	c (mm)	ⓘ
			LIL	LIB				
		100	UPRKW5		100	165	-	white weiss · blanco · beyaz · λευκό
		125	UPRKW8		125	225	-	
		100	UPRKS5		100	165	-	black schwarz · negro · siyah · Μαύρο
		125	UPRKS8		125	225	-	

LIL  
LIB

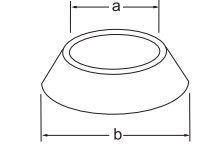
# INTERNAL CONCENTRIC AIR-GAS FLUE SYSTEM

**LIL/LIB**

KONZENTRISCHES LUFT-ABGASSYSTEM

**LIL - PPH/stainless steel – white powder coated**

SISTEMA DE EVACUACIÓN CONCÉNTRICO PARA EL INTERIOR

PPH/Edelstahl weiss pulverbeschichtet

EŞ MERKEZLİ KAPALI BACA SİSTEMİ

PPH/acero inoxidable en epoxi blanco

ΟΜΟΚΕΝΤΡΙΚΟ ΣΥΣΤΗΜΑ ΚΑΠΝΟΔΟΧΟΥ ΕΣΩΤΕΡΙΚΗΣ ΧΡΗΣΗΣ

PPH/paslanmaz çelik - beyaz toz boyalı

PPH/χάλυβας - λευκή ηλεκτροστατική βαφή



**LIB - PPH/stainless steel – polished**

**Ø60/100 – 200/300 mm**

PPH/Edelstahl hochglanz · PPH/acero inoxidable pulido  
PPH/paslanmaz çelik - cilalı · PPH/ανοξειδωτος χάλυβας



## LIL/LIB One-piece cover plate

LIL/LIB Abdeckblende · LIL/LIB Remate mural · LIL/LIB Tek parça kapak plakası · LIL/LIB Πλάκα κάλυψης ενός τμήματος

	Ø	Code Código Kod Κωδ.		a (mm)	b (mm)	c (mm)	d (mm)
		LIL	LIB				
	60/100	LPWL05	LPWB05	250	103	-	-
	80/125	LPWL08	LPWB08	250	128	-	-
	100/150	LPWL0X	-	250	155	-	-
	110/160	LPWL01	LPWB01	250	165	-	-
	125/180	LPWL02	LPWB02	400	182	-	-
	160/225	LPWL06	LPWB06	400	227	-	-
	200/300	LPWL00	LPWB00	-	-	-	-

## LIL/LIB Two-piece cover plate

LIL/LIB Abdeckblende 2-teilig · LIL/LIB Remate mural seccionado · LIL/LIB İki parçalı kapak plakası · LIL/LIB Πλάκα κάλυψης δύο τμημάτων

	Ø	Code Código Kod Κωδ.		a (mm)	b (mm)	c (mm)	d (mm)
		LIL	LIB				
	60/100	LPW2L5	LPW2B5	115	160	101	85
	80/125	LPW2L8	LPW2B8	145	180	127	120
	100/150	LPW2LX	-	155	230	155	130
	110/160	LPW2L1	LPW2B1	165	230	165	130
	125/180	LPW2L2	LPW2B2	-	-	-	-
	160/225	LPW2L6	LPW2B6	-	-	-	-
	200/300	LPW2L0	LPW2B0	-	-	-	-

## LIL/LIB Wall terminal (horizontal)

LIL/LIB Ausblasstutzen · LIL/LIB Terminal horizontal · LIL/LIB Duvar terminali (yatay) · LIL/LIB Οριζόντιο τερματικό

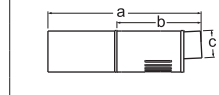
	Ø	Code Código Kod Κωδ.		a (mm)	b (mm)	c (mm)	d (mm)
		LIL	LIB				
	60/100	APASL5	APASB5	340	190	83	-
	80/125	APASL8	APASB8	340	190	83	-
	100/150	APASLX	-	400	250	115	-
	110/160	APASL1	APASB1	400	250	115	-
	125/180	APASL2	APASB2	-	-	-	-
	160/225	APASL6	APASB6	-	-	-	-
	200/300	APASL0	APASB0	-	-	-	-

## ZUB Roof terminal adjustable (complete)

ZUB Dachaufsatz var. (komplett) · ZUB Terminal vertical var. (completo) · ZUB Tavan terminali ayarlanabilir (komple) · ZUB Κάθετο τερματικό στέγης πτυσσόμενο (πλήρες)

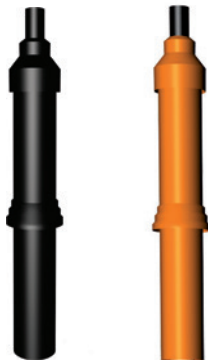
	Ø	Code Código Kod Κωδ.		a (mm)	b (mm)	i
		LIL	LIB			
	60/100	DPDS45-V		150-600	1100	<b>Plastic-black</b> Kunststoff - schwarz
	80/125	DPDS48-V		150-600	1100	Plástico negro
	110/160	DPDS41-V		150-600	1100	Plastik - siyah
	60/100	DPDT45-V		150-600	1100	Πλαστικό - μαύρο χρώμα
	80/125	DPDT48-V		150-600	1100	<b>Plastic-terracotta</b> Kunststoff - terracotta
	110/160	DPDT41-V		150-600	1100	Plástico terracotta
	60/100	DPDS15-V		150-1100	1600	Plastik - terracotta
	80/125	DPDS11-V		150-1100	1600	Plastik - siyah
	110/160	DPDS18-V		150-1100	1600	Πλαστικό - μαύρο χρώμα
	60/100	DPDT15-V		150-1100	1600	<b>Plastic-terracotta</b> Kunststoff - terracotta
	80/125	DPDT18-V		150-1100	1600	Plástico terracotta
	110/160	DPDT11-V		150-1100	1600	Plastik - terracotta

# INTERNAL CONCENTRIC AIR-GAS FLUE SYSTEM

**LIL/LIB**

KONZENTRISCHES LUFT-ABGASSYSTEM

**LIL - PPH/stainless steel – white powder coated**

SISTEMA DE EVACUACIÓN CONCÉNTRICO PARA EL INTERIOR

PPH/Edelstahl weiss pulverbeschichtet

EŞ MERKEZLİ KAPALI BACA SİSTEMİ

PPH/acero inoxidable en epoxi blanco

ΟΜΟΚΕΝΤΡΙΚΟ ΣΥΣΤΗΜΑ ΚΑΠΝΟΔΟΧΟΥ ΕΣΩΤΕΡΙΚΗΣ ΧΡΗΣΗΣ

PPH/paslanmaz çelik - beyaz toz boyalı

PPH/χάλυβας - λευκή ηλεκτροστατική βαφή

**LIB - PPH/stainless steel – polished**

PPH/Edelstahl hochglanz · PPH/acero inoxidable pulido

PPH/paslanmaz çelik - cilalı · PPH/ανοξειδωτος χάλυβας

**Ø60/100 – 200/300 mm**

**ZUB Universal roof flashing 5° - 55° UNI (complete)**  
 ZUB Universal-Dachpfanne 5° - 55° UNI (komplett) • ZUB Salida techo universal 5° - 55° (completa) • ZUB Üniversal çatı flaşörü 5° - 55° UNI (komple) • ZUB Διάβαση στέγης καπνοδόχου 5° - 55° UNI (πλήρες)

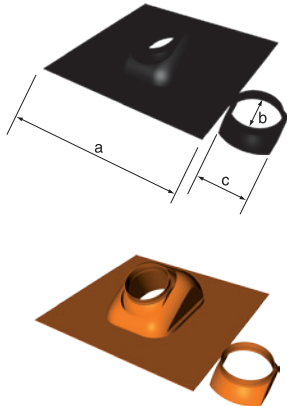
	Ø	Code Código Kod Κωδ.		a (mm)	b (mm)	c (mm)	i
		LIL	LIB				
	5° - 25°	60/100 - 80/125	ZUD02S	500	138	132	Plastic - black Kunststoff - schwarz Plástico negro Plastik - siyah Πλαστικό - μαύρο
		110/160	ZUD06S	700	165	180	Plástico negro Plastik - siyah Πλαστικό - μαύρο
		60/100 - 80/125	ZUD02T	500	138	132	Plastic - terracotta Kunststoff - terracotta Plástico terracota Plastik - terracotta Πλαστικό - τερακότα
		110/160	ZUD06T	700	165	180	Plástico terracota Plastik - terracotta Πλαστικό - τερακότα
	25° - 45°	60/100 - 80/125	ZUD22S	500	138	132	Plastic - black Kunststoff - schwarz Plástico negro Plastik - siyah Πλαστικό - μαύρο
		110/160	ZUD26S	700	165	180	Plástico negro Plastik - siyah Πλαστικό - μαύρο
		60/100 - 80/125	ZUD22T	500	138	132	Plastic - terracotta Kunststoff - terracotta Plástico terracota Plastik - terracotta Πλαστικό - τερακότα
		110/160	ZUD26T	700	165	180	Plástico terracota Plastik - terracotta Πλαστικό - τερακότα
	35° - 55°	60/100 - 80/125	ZUD32S	500	138	132	Plastic - black Kunststoff - schwarz Plástico negro Plastik - siyah Πλαστικό - μαύρο
		110/160	ZUD36S	700	165	180	Plástico negro Plastik - siyah Πλαστικό - μαύρο
		60/100 - 80/125	ZUD32T	500	138	132	Plastic - terracotta Kunststoff - terracotta Plástico terracota Plastik - terracotta Πλαστικό - τερακότα
		110/160	ZUD36T	700	165	180	Plástico terracota Plastik - terracotta Πλαστικό - τερακότα

**ZUB Roof flashing**  
 ZUB Dachpfanne • ZUB Salida techo • ZUB Çatı flashingleri • ZUB Διάβαση στέγης καπνοδόχου

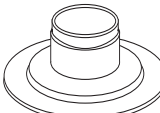
	Ø	Code Código Kod Κωδ.		a (mm)	b (mm)	i
		LIL	LIB			
	60/100 - 80/125	ALPP35		-	-	Plastic - black Kunststoff - schwarz • Plástico negro
	-	-		-	-	• Plastik - siyah • Πλαστικό - μαύρο
	-	-		-	-	χρώμα

LIL  
LIB

# INTERNAL CONCENTRIC AIR-GAS FLUE SYSTEM

**LIL/LIB**

KONZENTRISCHES LUFT-ABGASSYSTEM

**LIL - PPH/stainless steel – white powder coated**

SISTEMA DE EVACUACIÓN CONCÉNTRICO PARA EL INTERIOR

PPH/Edelstahl weiss pulverbeschichtet

EŞ MERKEZLİ KAPALI BACA SİSTEMİ

PPH/acero inoxidable en epoxi blanco

ΟΜΟΚΕΝΤΡΙΚΟ ΣΥΣΤΗΜΑ ΚΑΠΝΟΔΟΧΟΥ ΕΣΩΤΕΡΙΚΗΣ ΧΡΗΣΗΣ

PPH/paslanmaz çelik - beyaz toz boyalı

PPH/χάλυβας - λευκή ηλεκτροστατική βαφή

**Ø60/100 – 200/300 mm**

**LIB - PPH/stainless steel – polished**

PPH/Edelstahl hochglanz · PPH/acero inoxidable pulido

PPH/paslanmaz çelik - cilalı · PPH/ανοξειδωτος χάλυβας

## LIL/LIB Boiler adapter

LIL/LIB Kesseladapter • LIL/LIB Adapt. caldera • LIL/LIB Kazan adaptörü • LIL/LIB Συστολή λέβητα



LIL



LIB

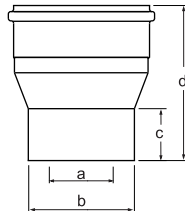

Ø	Code Código Kod Κωδ.		a (mm)	b (mm)	c (mm)	d (mm)
	LIL	LIB				
60/100	LPKL56	LPKB56	60	98	70	120
60/100	LPKL51	LPKB51	63	96	65	120
60/100	LPKL52	LPKB52	70	110	95	150
60/100	LPKL53	LPKB53	80	110	95	150
60/100	LPKL54	LPKB54	80	126	75	150
60/100	LPKL55	LPKB55	80	125	75	150
80/125	LPKL87	LPKB87	60	98	50	125
80/125	LPKL01	LPKB01	60	100	47	120
80/125	LPKL02	LPKB02	63	96	45	125
80/125	LPKL03	LPKB03	70	100	45	120
80/125	LPKL85	LPKB85	70	110	45	120
80/125	LPKL81	LPKB81	80	110	45	120
80/125	LPKL04	LPKB04	80	122	60	120
80/125	LPKL83	LPKB83	80	126	65	120
80/125	LPKL84	LPKB84	80	130	40	120
80/125	LPKL82	LPKB82	100	150	70	150
80/125	LPKL86	LPKB86	110	160	65	150
100/150	LPKL5X	-	60	100	45	145
100/150	LPKL8X	-	80	125	60	145
100/150	LPKL1X	-	110	160	85	145
110/160	LPKL11	LPKB11	80	110	60	145
110/160	LPKL06	LPKB06	80	125	60	145
110/160	LPKL10	LPKB10	80	130	60	145
110/160	LPKL07	LPKB07	100	130	60	145
110/160	LPKL08	LPKB08	100	125	65	150
110/160	LPKL09	LPKB09	100	150	60	150
110/160	LPKL26	LPKB26	125	180	60	150
125/180	LPKL21	LPKB21	80	110	-	-
125/180	LPKL22	LPKB22	80	125	-	-
125/180	LPKL23	LPKB23	100	150	85	190
125/180	LPKL24	LPKB24	110	160	85	185
160/225	LPKL61	LPKB61	100	150	-	-
160/225	LPKL62	LPKB62	110	160	-	-
160/225	LPKL63	LPKB63	125	180	-	-
200/300	LPKLY1	LPKBY1	100	150	-	-
200/300	LPKLY2	LPKBY2	110	160	-	-
200/300	LPKLY3	LPKBY3	125	180	-	-
200/300	LPKLY4	LPKBY4	160	225	-	-

# INTERNAL CONCENTRIC AIR-GAS FLUE SYSTEM

**LIL/LIB**

KONZENTRISCHES LUFT-ABGASSYSTEM

**LIL - PPH/stainless steel – white powder coated**

SISTEMA DE EVACUACIÓN CONCÉNTRICO PARA EL INTERIOR

PPH/Edelstahl weiss pulverbeschichtet

EŞ MERKEZLİ KAPALI BACA SİSTEMİ

PPH/acero inoxidable en epoxi blanco

ΟΜΟΚΕΝΤΡΙΚΟ ΣΥΣΤΗΜΑ ΚΑΠΝΟΔΟΧΟΥ ΕΣΩΤΕΡΙΚΗΣ ΧΡΗΣΗΣ

PPH/paslanmaz çelik - beyaz toz boyalı

PPH/χάλυβας - λευκή ηλεκτροστατική βαφή

**Ø60/100 – 200/300 mm**

**LIB - PPH/stainless steel – polished**

PPH/Edelstahl hochglanz · PPH/acero inoxidable pulido

PPH/paslanmaz çelik - cilalı · PPH/ανοξειδωτος χάλυβας

## LIL/LIB Boiler adapter w. 2 test plugs

LIL/LIB Messstück reduziert · LIL/LIB Adapt. cald. con 2 tm./muestras · LIL/LIB 2 test fişli kazan adaptörü · LIL/LIB Συστολή λέβητα με 2 σημεία μέτρησης

Ø	Code Código Kod Κωδ.		a (mm)	b (mm)	c (mm)	d (mm)
	LIL	LIB				
60/100	LPML56	LPMB56	60	98	80	80
60/100	LPML51	LPMB51	63	96	80	80
60/100	LPML52	LPMB52	70	110	85	75
60/100	LPML53	LPMB53	80	110	85	75
60/100	LPML55	LPMB55	80	125	100	80
60/100	LPML54	LPMB54	80	126	100	80
80/125	LPML87	LPMB87	60	98	110	75
80/125	LPML81	LPMB81	60	100	110	75
80/125	LPML81-LET	-	60	100	110	75
80/125	LPML82	LPMB82	63	96	110	75
80/125	LPML83	LPMB83	70	110	85	75
80/125	LPML84	LPMB84	80	110	85	75
80/125	LPML85	LPMB85	80	126	85	75
80/125	LPML86	LPMB86	80	130	85	75
100/150	LPML5X	-	60	100	120	75
100/150	LPML8X	-	80	125	110	75
100/150	LPML1X	-	110	160	90	75
110/160	LPML11	LPMB11	80	110	120	75
110/160	LPML12	LPMB12	80	125	110	75
110/160	LPML08	LPMB08	100	125	85	75
110/160	LPML13	LPMB13	100	150	90	75
125/180	LPML21	LPMB21	80	110	-	-
125/180	LPML22	LPMB22	80	125	-	-
125/180	LPML23	LPMB23	100	150	-	-
125/180	LPML24	LPMB24	110	160	-	-
160/225	LPML61	LPMB61	100	150	-	-
160/225	LPML62	LPMB62	110	160	-	-
160/225	LPML63	LPMB63	125	180	-	-
200/300	LPML01	LPMB01	100	150	-	-
200/300	LPML02	LPMB02	110	160	-	-
200/300	LPML03	LPMB03	125	180	-	-
200/300	LPML04	LPMB04	160	225	-	-

LIL

LIB

# INTERNAL CONCENTRIC AIR-GAS FLUE SYSTEM

**LIL/LIB**

KONZENTRISCHES LUFT-ABGASSYSTEM

SISTEMA DE EVACUACIÓN CONCÉNTRICO PARA EL INTERIOR

EŞ MERKEZLİ KAPALI BACA SİSTEMİ

ΟΜΟΚΕΝΤΡΙΚΟ ΣΥΣΤΗΜΑ ΚΑΠΝΟΔΟΧΟΥ ΕΣΩΤΕΡΙΚΗΣ ΧΡΗΣΗΣ

**Ø60/100 – 200/300 mm**

**LIL - PPH/stainless steel – white powder coated**

PPH/Edelstahl weiss pulverbeschichtet

PPH/acero inoxidable en epoxi blanco

PPH/paslanmaz çelik - beyaz toz boyalı

PPH/χάλυβας - λευκή ηλεκτροστατική βαφή

**LIB - PPH/stainless steel – polished**

PPH/Edelstahl hochglanz · PPH/acero inoxidable pulido

PPH/paslanmaz çelik - cilalı · PPH/ανοξειδωτος χάλυβας

## LIL/LIB Boiler adapter eccentric

LIL/LIB Kesselanschluss exzentrisch · LIL/LIB Adapt. caldera excéntrico · LIL/LIB Kazan adaptörü eksantrik · LIL/LIB Συστολή λέβητα - έκκεντρη

	Ø	Code Código Kod Κωδ.		a (mm)	b (mm)	c (mm)	d (mm)		
		LIL	LIB						
 <p>LIL</p>	* Socket 80/125	60/100	LPKXL58	LPKXB58	100	126	-	-	
		-	-	-	-	-	-	-	-
		-	-	-	-	-	-	-	-
		-	-	-	-	-	-	-	-
	* Socket 110/160	60/100	LPKXL51	LPKXB51	160	100	-	-	
		80/125	LPKXL81	LPKXB81	160	125	-	-	
		-	-	-	-	-	-	-	
		-	-	-	-	-	-	-	
	* Socket 125/180	60/100	LPKXL52	LPKXB52	180	100	-	-	
		80/125	LPKXL82	LPKXB82	180	125	-	-	
		110/160	LPKXL12	LPKXB12	-	-	-	-	
		-	-	-	-	-	-	-	
* Socket 160/225	60/100	LPKXL56	LPKXB56	225	100	-	-		
	80/125	LPKXL86	LPKXB86	225	125	-	-		
	110/160	LPKXL16	LPKXB16	225	160	-	-		
	125/180	LPKXL26	LPKXB26	225	180	-	-		
* Socket 200/300	60/100	LPKXL50	LPKXB50	300	100	-	-		
	80/125	LPKXL80	LPKXB80	300	125	-	-		
	110/160	LPKXL10	LPKXB10	300	160	-	-		
	125/180	LPKXL20	LPKXB20	300	180	-	-		
	160/225	LPKXL60	LPKXB60	300	225	-	-		

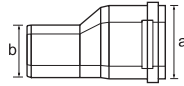

LIL

LIB

\* Socket · Muffe · Manguito · Soket · υποδοχή

# INTERNAL CONCENTRIC AIR-GAS FLUE SYSTEM

**LIL/LIB**

KONZENTRISCHES LUFT-ABGASSYSTEM

**LIL - PPH/stainless steel – white powder coated**

SISTEMA DE EVACUACIÓN CONCÉNTRICO PARA EL INTERIOR

PPH/Edelstahl weiss pulverbeschichtet

EŞ MERKEZLİ KAPALI BACA SİSTEMİ

PPH/acero inoxidable en epoxi blanco

ΟΜΟΚΕΝΤΡΙΚΟ ΣΥΣΤΗΜΑ ΚΑΠΝΟΔΟΧΟΥ ΕΣΩΤΕΡΙΚΗΣ ΧΡΗΣΗΣ

PPH/paslanmaz çelik - beyaz toz boyalı

PPH/χάλυβας - λευκή ηλεκτροστατική βαφή

**LIB - PPH/stainless steel – polished**

**Ø60/100 – 200/300 mm**

PPH/Edelstahl hochglanz · PPH/acero inoxidable pulido  
PPH/paslanmaz çelik - cilalı · PPH/ανοξειδωτος χάλυβας

## LIL/LIB Boiler Adapter-Tee with test plug (reduced)

LIL/LIB Umlenk-T m. MÖ (reduziert) • LIL/LIB Te-Adapt. cald. con tm./muestras (reducida) • LIL/LIB Kazan Adaptörü-Tee test tapalı (azaltılmış)  
• LIL/LIB Ταφ με θυρίδα επιθεώρησης και σημείο μέτρησης (συστολικό)

	Ø	Code Código Kod Kωδ.		a (mm)	b (mm)	c (mm)	d (mm)
		LIL	LIB				
	60/100	LPTL56	LPTB56	60	98	165	290
	60/100	LPTL51	LPTB51	63	96	165	290
	60/100	LPTL52	LPTB52	70	110	165	290
	60/100	LPTL53	LPTB53	80	110	165	290
	60/100	LPTL55	LPTB55	80	125	165	290
	60/100	LPTL54	LPTB54	80	126	165	290
	80/125	LPTL87	LPTB87	60	98	190	340
	80/125	LPTL81	LPTB81	60	100	190	340
	80/125	LPTL81-LET	-	60	100	190	340
	80/125	LPTL82	LPTB82	63	96	190	340
	80/125	LPTL83	LPTB83	70	110	190	340
	80/125	LPTL84	LPTB84	80	110	190	340
	80/125	LPTL85	LPTB85	80	126	190	340
	80/125	LPTL86	LPTB86	80	130	190	340
	100/150	LPTL5X	-	60	100	210	375
	100/150	LPTL8X	-	80	125	210	375
100/150	LPTL1X	-	110	160	210	375	
110/160	LPTL11	LPTB11	80	110	210	375	
110/160	LPTL12	LPTB12	80	125	210	375	
110/160	LPTL13	LPTB13	100	150	210	375	
125/180	LPTL21	LPTB21	80	110	225	382	
125/180	LPTL22	LPTB22	80	125	225	382	
125/180	LPTL23	LPTB23	100	150	225	382	
125/180	LPTL24	LPTB24	110	160	225	382	
160/225	LPTL61	LPTB61	100	150	255	427	
160/225	LPTL62	LPTB62	110	160	255	427	
160/225	LPTL63	LPTB63	125	180	255	427	
200/300	LPTL01	LPTB01	100	150	305	502	
200/300	LPTL02	LPTB02	110	160	305	502	
200/300	LPTL03	LPTB03	125	180	305	502	
200/300	LPTL04	LPTB04	160	225	305	502	

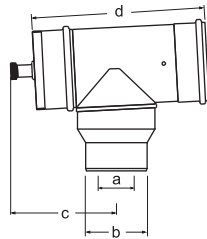

LIL

LIB

# EXTERNAL CONCENTRIC AIR-GAS FLUE SYSTEM

KONZENTRISCHES AUSSENWANDSYSTEM

SISTEMA DE EVACUACIÓN CONCÉNTRICO PARA EL EXTERIOR

EŞ MERKEZLİ KAPALI BACA SİSTEMİ

ΟΜΟΚΕΝΤΡΙΚΟ ΣΥΣΤΗΜΑ ΚΑΠΝΟΔΟΧΟΥ ΕΣΩΤΕΡΙΚΗΣ ΧΡΗΣΗΣ

**Ø60/100 – 200/300 mm**

**LAB**

PPH/stainless steel – polished

PPH/Edelstahl hochglanz

PPH/acero inoxidable pulido

PPH/paslanmaz çelik - cilalı

PPH/ανοξειδωτος χάλυβας

1	APMSB5
2	APRB15
3	APWHB5
4	APVUBU
5	APRZB5
6	APSBB5
7	APWKB5
8	APW1B5
9	LPW2B5

LAB			
Ø (mm)	Inner dimension of socket Innenmass des Rohres Dimensión interior del tubo Soketin iç boyutu Εσωτερική διατομή υποδοχής (mm)	Wall thickness Wandstärke Espesor de pared Duvar kalınlığı Πάχος τοιχώματος (mm)	Outer dimension of socket Aussenmass der Muffe Dimensión exterior del manguito Soketin dış boyutu Εξωτερική διατομή υποδοχής (mm)
60/100	105	0,6	106,2
80/125	128	0,6	129,2
110/160	163	0,6	164,2
125/150	182,6	0,6	183,2
160/225	228	0,6	229,2
200/300	301,6	0,6	302,8

LAB

**When assembling horizontal piping, it is necessary to create a slope towards the boiler at minimum of 3°.**

Gefälle schaffen waagerechte Verbindungsleitung muss zum Kessel immer ein Gefälle von mindestens 3° haben.

Al montar las tuberías horizontales, es necesario crear una pendiente hacia la caldera de un mínimo de 3°.

Yatay boru tesisatını monte ederken, kazana doğru en az 3°'lik bir eğim oluşturmak gerekir.

Κατά την εγκατάσταση οριζόντιων σωληνώσεων, πρέπει να υπάρχει κλίση προς τον λέβητα τουλάχιστον 3°.

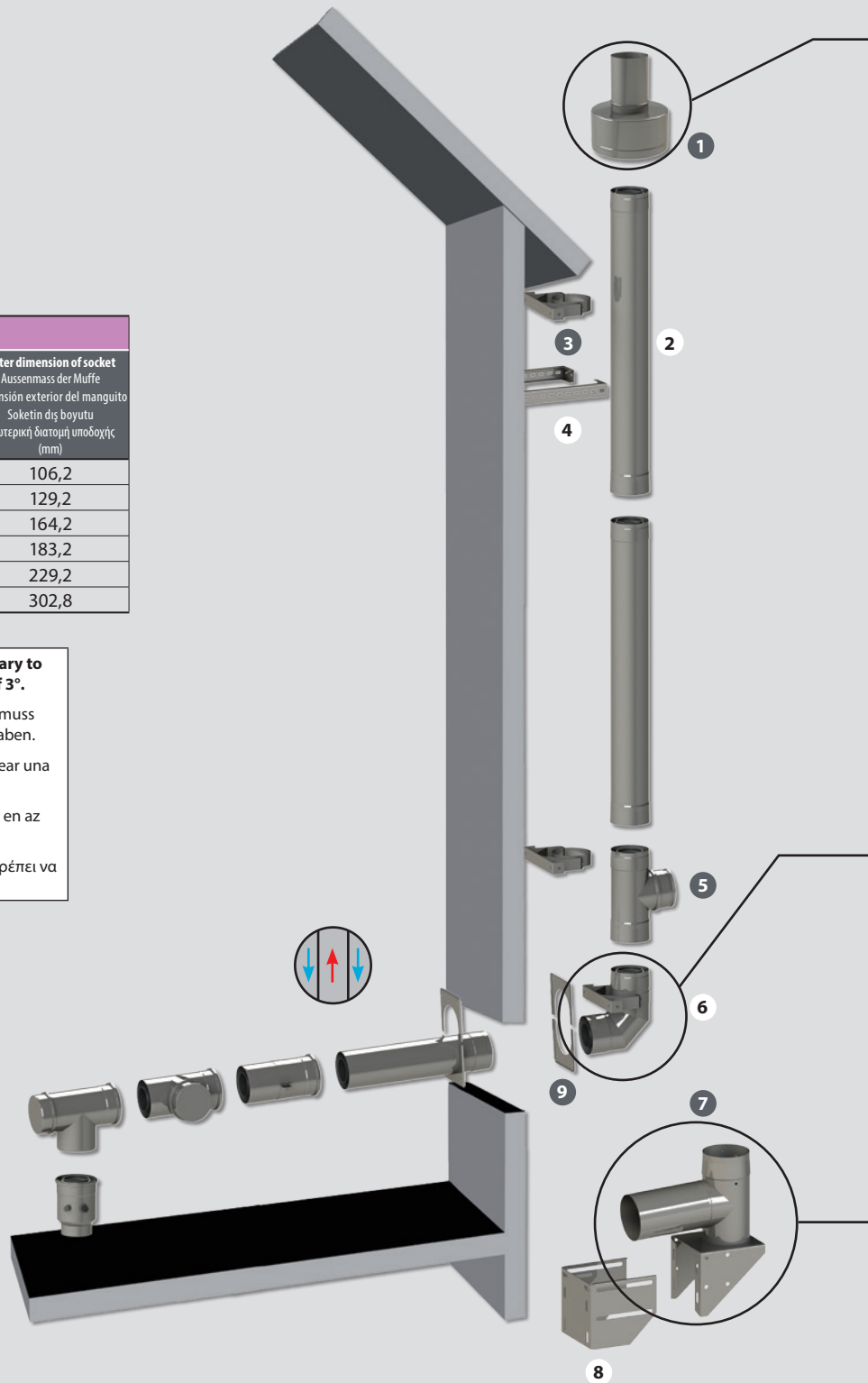

# EXTERNAL CONCENTRIC AIR-GAS FLUE SYSTEM

KONZENTRISCHES AUSSENWANDSYSTEM

SISTEMA DE EVACUACIÓN CONCÉNTRICO PARA EL EXTERIOR

EŞ MERKEZLİ KAPALI BACA SİSTEMİ

ΟΜΟΚΕΝΤΡΙΚΟ ΣΥΣΤΗΜΑ ΚΑΠΝΟΔΟΧΟΥ ΕΣΩΤΕΡΙΚΗΣ ΧΡΗΣΗΣ

**Ø60/100 – 200/300 mm**

**LAB**

PPH/stainless steel – polished

PPH/Edelstahl hochglanz

PPH/acero inoxidable pulido

PPH/paslanmaz çelik - cilalı

PPH/ανοξειδωτος χάλυβας



**Insert LAB opening with suction into the last pipe with socket.**

LAB Mündungsrohr in letzte PPH-Muffe einstecken

Insertar el tubo del LAB terminal con entrada de aire en el manguito del último tubo PPH.

Εισάγετε το άνοιγμα LAB με αναρρόφηση στον τελευταίο σωλήνα με υποδοχή.

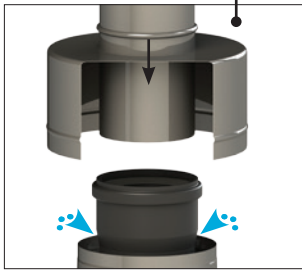

**LAB tee with inspection door with air supply enables suction of combustion air.**

Verbrennungsluft wird durch LAB Revisions-T mit Zuluft angesaugt.

La LAB Te-inspección con entrada de aire permite la aspiración del aire de combustión.

Hava beslemeli kontrol kapılı LAB tee, yanma havasının emilmesini sağlar.

Ταφ με θυρίδα επιθεώρησης LAB και παροχή αέρα που επιτρέπει την αναρρόφηση του αέρα καύσης.

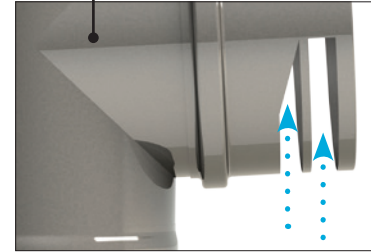

**Combination of LAB elbow 87° with wall bracket (reinforced) and LAB pipe.**

Kombination aus LAB Stützbogen mit Wandkonsole (verstärkt) und LAB Rohr.

Combinación de LAB codo de apoyo 87° con soporte pared (reforzado) y LAB Tubo.

LAB dirsek kombinasyonu 87° duvar braketi ile (güçlendirilmiş) ve LAB borusu.

Συνδυασμός καμπύλης 87° με στήριγμα τοίχου LAB (ενισχυμένο).

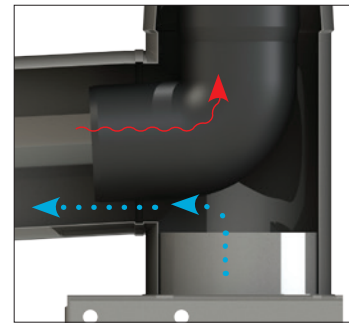
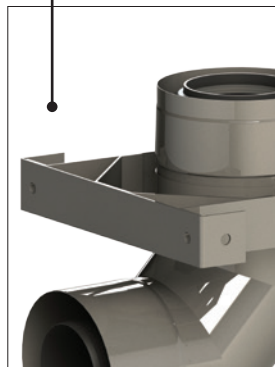

- **Combustion gas** Atık gaz  
Abgasstrom Καυσαέρια  
Gases de combustión
- **Combustion air** Yanma havası  
Verbrennungsluft Αέρας καύσης  
Aire de combustion

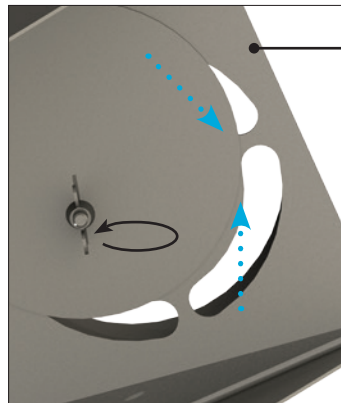
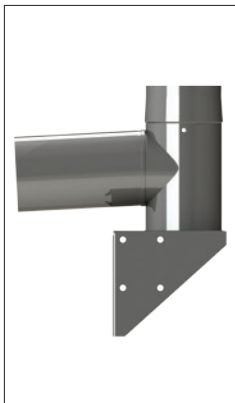

**Eccentrically placed wheel on LAB heel elbow 87° with support bracket allows gas regulation of weight flow of combustion air.**

Exzentrisch gelagerte Zuluftscheibe, ermöglicht stufenlose Begrenzung des Zuluftstromes.

El disco posicionado excéntrico en la parte inferior entre los soportes de la LAB Base mural, permite una fácil regulación del aire de combustión.

Destek braketli 87° LAB topuk dirseği üzerine eksantrik olarak yerleştirilmiş tekerlek, yanma havasının ağırlık.

Έκκεντρο καπάκι εισόδου αέρα καύσης σε καμπύλη στήριξης LAB 87° με βραχίονα στήριξης που επιτρέπει την επιπλέον ρύθμιση των καυσαερίων.

**Δεν κατασκευάσαμε ένα νέο σύστημα καπνοδόχου, το βελτιώσαμε !**

# EXTERNAL CONCENTRIC AIR-GAS FLUE SYSTEM

KONZENTRISCHES AUSSENWANDSYSTEM

SISTEMA DE EVACUACIÓN CONCÉNTRICO PARA EL EXTERIOR

EŞ MERKEZLİ KAPALI BACA SİSTEMİ

ΟΜΟΚΕΝΤΡΙΚΟ ΣΥΣΤΗΜΑ ΚΑΠΝΟΔΟΧΟΥ ΕΣΩΤΕΡΙΚΗΣ ΧΡΗΣΗΣ

**Ø60/100 – 200/300 mm**

**LAL**

PPH/stainless steel-white powder coated

PPH/Edelstahl weiss pulverbeschichtet

PPH/acero inoxidable en epoxy blanco

PPH/paslanmaz çelik - beyaz toz boyalı

PPH/ανοξειδωτος χάλυβας - ηλεκτροστατική βαφή

1	APMSL5
2	APRL15
3	APWHL5
4	APVULU
5	APRZL5
6	APSBL5
7	APWKL5
8	APW1L5
9	LPW2L5

LAL			
Ø (mm)	Inner dimension of socket Innenmass des Rohres Dimensión interior del tubo Soketin iç boyutu Εσωτερική διατομή υποδοχής (mm)	Wall thickness Wandstärke Espesor de pared Duvar kalınlığı Πάχος τοιχώματος (mm)	Outer dimension of socket Ausßenmass der Muffe Dimensión exterior del manguito Soketin dış boyutu Εξωτερική διατομή υποδοχής (mm)
60/100	105	0,6	106,2
80/125	128	0,6	129,2
110/160	163	0,6	164,2
125/150	182,6	0,6	183,2
160/225	228	0,6	229,2
200/300	301,6	0,6	302,8

LAL



**When assembling horizontal piping, it is necessary to create a slope towards the boiler at minimum of 3°.**

Gefälle schaffen waagerechte Verbindungsleitung muss zum Kessel immer ein Gefälle von mindestens 3° haben.

Al montar las tuberías horizontales, es necesario crear una pendiente hacia la caldera de un mínimo de 3°.

Yatay boru tesisatını monte ederken, kazana doğru en az 3°'lik bir eğim oluşturmak gerekir.

Κατά την εγκατάσταση οριζόντιων σωληνώσεων, πρέπει να υπάρχει κλίση προς τον λέβητα τουλάχιστον 3°.

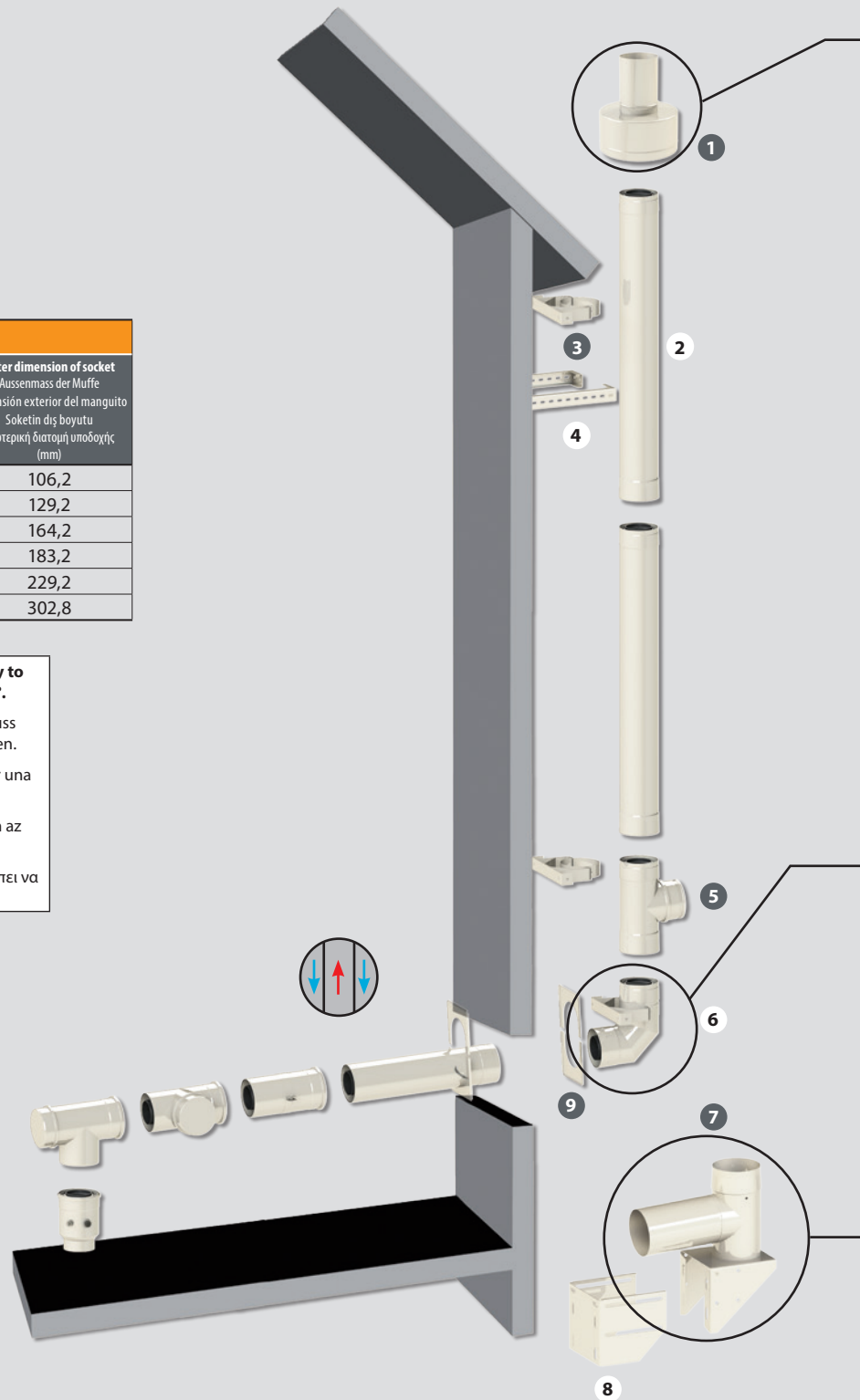

# EXTERNAL CONCENTRIC AIR-GAS FLUE SYSTEM

KONZENTRISCHES AUSSENWANDSYSTEM

SISTEMA DE EVACUACIÓN CONCÉNTRICO PARA EL EXTERIOR

EŞ MERKEZLİ KAPALI BACA SİSTEMİ

ΟΜΟΚΕΝΤΡΙΚΟ ΣΥΣΤΗΜΑ ΚΑΠΝΟΔΟΧΟΥ ΕΣΩΤΕΡΙΚΗΣ ΧΡΗΣΗΣ

**Ø60/100 – 200/300 mm**

**LAL**

PPH/stainless steel-white powder coated

PPH/Edelstahl weiss pulverbeschichtet

PPH/acero inoxidable en epoxi blanco

PPH/paslanmaz çelik - beyaz toz boyalı

PPH/ανοξειδωτος χάλυβας - ηλεκτροστατική βαφή



**Insert LAL opening with suction into the last pipe with socket.**

LAL Mündungsrohr in letzte PPH-Muffe einstecken

Insertar el tubo del LAL terminal con entrada de aire en el manguito del último tubo PPH.

Emişli LAB açıklığını soketli son boruya yerleştirin.

Εισάγετε το άνοιγμα LAL με αναρρόφηση στον τελευταίο σωλήνα με υποδοχή.

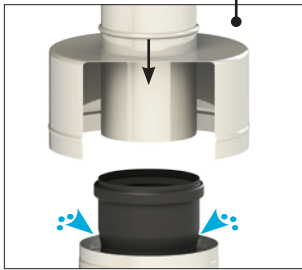

**LAL tee with inspection door with air supply enables suction of combustion air.**

Verbrennungsluft wird durch LAL Revisions-T mit Zuluft angesaugt.

La LAL Te-inspección con entrada de aire permite la aspiración del aire de combustión.

Hava beslemeli kontrol kapılı LAB tee, yanma havasının emilmesini sağlar.

Ταφ με θυρίδα επιθεώρησης LAL και παροχή αέρα που επιτρέπει την αναρρόφηση του αέρα καύσης.

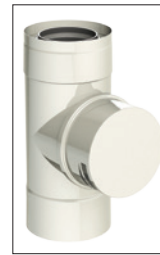

**Combination of LAL elbow 87° with wall bracket (reinforced) and LAL pipe.**

Kombination aus LAL Stützbogen mit Wandkonsole (verstärkt) und LAL Rohr.

Combinación de LAL codo de apoyo 87° con soporte pared (reforzado) y LAL Tubo.

LAB dirsek kombinasyonu 87° duvar braketi ile (güçlendirilmiş) ve LAB borusu.

Συνδυασμός καμπύλης 87° με στήριγμα τοίχου LAL (ενισχυμένο).

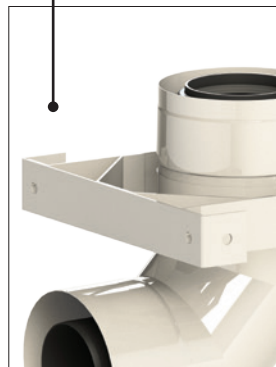

**Eccentrically placed wheel on LAL heel elbow 87° with support bracket allows gas regulation of weight flow of combustion air.**

Exzentrisch gelagerte Zuluftscheibe, ermöglicht stufenlose Begrenzung des Zuluftstromes.

El disco posicionado excéntrico en la parte inferior entre los soportes de la LAL Base mural, permite una fácil regulación del aire de combustión.

Destek braketli 87° LAB topuk dirseği üzerine eksantrik olarak yerleştirilmiş tekerlek, yanma havasının ağırlık.

Έκκεντρο καπάκι εισόδου αέρα καύσης σε καμπύλη στήριξης LAL 87° με βραχίονα στήριξης που επιτρέπει την επιπλέον ρύθμιση των καυσαερίων.

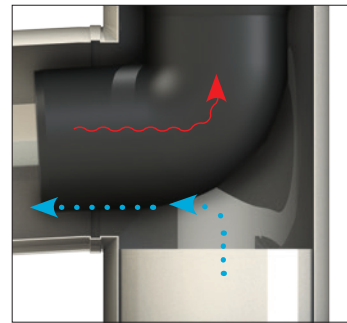

- **Combustion gas** Atık gaz  
Abgasstrom Καυσαέρια  
Gases de combustión
- **Combustion air** Yanma havası  
Verbrennungsluft Αέρας καύσης  
Aire de combustión

LAL

# EXTERNAL CONCENTRIC AIR-GAS FLUE SYSTEM

**LAB/LAL**

KONZENTRISCHES AUSSENWANDSYSTEM

LAB - PPH/stainless steel - polished

SISTEMA DE EVACUACIÓN CONCÉNTRICO PARA EL EXTERIOR

PPH/Edelstahl hochglanz · PPH/acero inoxidable pulido

EŞ MERKEZLİ KAPALI BACA SİSTEMİ

PPH/paslanmaz çelik - cilalı · PPH/ανοξειδωτος χάλυβας

ΟΜΟΚΕΝΤΡΙΚΟ ΣΥΣΤΗΜΑ ΚΑΠΝΟΔΟΧΟΥ ΕΣΩΤΕΡΙΚΗΣ ΧΡΗΣΗΣ

LAL - PPH/stainless steel-white powder coated

PPH/Edelstahl weiss pulverbeschichtet

PPH/acero inoxidable en epoxi blanco



PPH/paslanmaz çelik - beyaz toz boyalı

PPH/ανοξειδωτος χάλυβας - ηλεκτροστατική βαφή

**Ø60/100 – 200/300 mm**



## LAB/LAL Pipe with socket

LAB/LAL Rohr m. Muffe • LAB/LAL Tubo M/H • LAB/LAL Soketli boru • LAB/LAL Σωλήνα με υποδοχή (κεφάλι)

	Ø	Code Código Kod Κωδ.		a (mm)	b (mm)	c (mm)	d (mm)
		LAB	LAL				
	60/100	APRB05	APRL05	100	62	188	-
	80/125	APRB08	APRL08	125	62	188	-
	100/150	-	APRL0X	150	62	188	-
	110/160	APRB01	APRL01	160	62	188	-
	125/180	APRB02	APRL02	180	62	188	-
	160/225	APRB06	APRL06	225	62	188	-
	200/300	APRB00	APRL00	300	62	188	-
	60/100	APRB55	APRL55	100	62	438	-
	80/125	APRB58	APRL58	125	62	438	-
	100/150	-	APRL5X	150	62	438	-
	110/160	APRB51	APRL51	160	62	438	-
	125/180	APRB52	APRL52	180	62	438	-
	160/225	APRB56	APRL56	225	62	438	-
	200/300	APRB50	APRL50	300	62	438	-
	60/100	APRB15	APRL15	100	62	938	-
	80/125	APRB18	APRL18	125	62	938	-
	100/150	-	APRL1X	150	62	938	-
	110/160	APRB11	APRL11	160	62	938	-
	125/180	APRB12	APRL12	180	62	938	-
	160/225	APRB16	APRL16	225	62	938	-
	200/300	APRB10	APRL10	300	62	938	-

## LAB/LAL Adjustable pipe with clamp

LAB/LAL Schieberohr • LAB/LAL Tubo extensible • LAB/LAL Keleççeli ayarlanabilir boru • LAB/LAL Πτυσσόμενος σωλήνας με σφιγκτήρα

	Ø	Code Código Kod Κωδ.		a (mm)	b (mm)	c (mm)	d (mm)
		LAB	LAL				
	60/100	APSB25	APSL25	100	62	188	-
	80/125	APSB28	APSL28	125	62	188	-
	100/150	-	APSL2X	150	62	188	-
	110/160	APSB21	APSL21	160	62	188	-
	125/180	APSB22	APSL22	180	62	188	-
	160/225	APSB26	APSL26	225	62	188	-
	200/300	APSB20	APSL20	300	62	188	-
	60/100	APSB55	APSL55	100	62	438	-
	80/125	APSB58	APSL58	125	62	438	-
	100/150	-	APSL5X	150	62	438	-
	110/160	APSB51	APSL51	160	62	438	-
	125/180	APSB52	APSL52	180	62	438	-
	160/225	APSB56	APSL56	225	62	438	-
	200/300	APSB50	APSL50	300	62	438	-

## LAB/LAL Transition pipe

LAB/LAL Rohr zu StützBogen • LAB/LAL Tubo pr. codo apoyo • LAB/LAL Geçiş borusu • LAB/LAL Σωλήνας μετάβασης

	Ø	Code Código Kod Κωδ.		a (mm)	b (mm)	c (mm)	d (mm)
		LAB	LAL				
	60/100	APRSB5	APRSL5	100	62	448	-
	80/125	APRSB8	APRSL8	125	62	448	-
	100/150	-	APRSLX	150	62	448	-
	110/160	APRSB1	APRSL1	160	62	448	-
	125/180	APRSB2	APRSL2	180	62	448	-
	160/225	APRSB6	APRSL6	225	62	448	-
	200/300	APRSB0	APRSL0	300	62	448	-

# EXTERNAL CONCENTRIC AIR-GAS FLUE SYSTEM

**LAB/LAL**

KONZENTRISCHES AUSSENWANDSYSTEM

LAB - PPH/stainless steel - polished

SISTEMA DE EVACUACIÓN CONCÉNTRICO PARA EL EXTERIOR

PPH/Edelstahl hochglanz · PPH/acero inoxidable pulido

EŞ MERKEZLİ KAPALI BACA SİSTEMİ

PPH/paslanmaz çelik - cilalı · PPH/ανοξειδωτος χάλυβας

ΟΜΟΚΕΝΤΡΙΚΟ ΣΥΣΤΗΜΑ ΚΑΠΝΟΔΟΧΟΥ ΕΣΩΤΕΡΙΚΗΣ ΧΡΗΣΗΣ

LAL - PPH/stainless steel-white powder coated

PPH/Edelstahl weiss pulverbeschichtet

PPH/acero inoxidable en epoxi blanco

PPH/paslanmaz çelik - beyaz toz boyalı

PPH/ανοξειδωτος χάλυβας - ηλεκτροστατική βαφή

**Ø60/100 – 200/300 mm**

## LAB/LAL Inspection-Tee

LAB/LAL Revisions-T • LAB/LAL Te-Inspección • LAB/LAL Muayene-Keçe LAB/LAL Muayene-Keçe • LAB/LAL Ταφ με θυρίδα επιθεώρησης

Ø	Code Código Kod Κωδ.		a (mm)	b (mm)	c (mm)	d (mm)
	LAB	LAL				
60/100	APRTB5	APRTL5	100	62	90	150
80/125	APRTB8	APRTL8	125	62	90	150
100/150	-	APRTLX	150	62	100	170
110/160	APRTB1	APRTL1	160	62	100	170
125/180	APRTB2	APRTL2	180	62	120	190
160/225	APRTB6	APRTL6	225	62	150	220
200/300	APRTB0	APRTL0	300	62	150	220

## LAB/LAL Inspection-Tee with air intake

LAB/LAL Revisions-T m. Zuluft • LAB/LAL Te-Inspecc. con entrada de aire • LAB/LAL Hava girişli Muayene Keçesi  
• LAB/LAL Ταφ με θυρίδα επιθεώρησης και παροχή αέρα καύσης

Ø	Code Código Kod Κωδ.		a (mm)	b (mm)	c (mm)	d (mm)
	LAB	LAL				
60/100	APRZB5	APRZL5	100	62	90	150
80/125	APRZB8	APRZL8	125	62	90	150
100/150	-	APRZLX	150	62	100	170
110/160	APRZB1	APRZL1	160	62	100	170
125/180	APRZB2	APRZL2	180	62	120	190
160/225	APRZB6	APRZL6	225	62	150	220
200/300	APRZB0	APRZL0	300	62	150	220

## LAB/LAL Tee-Piece with air intake w/o inspection

LAB/LAL T-Stk. mit Zuluft ohne Revision • LAB/LAL Te con entrada de aire (sin inspec.) • LAB/LAL Kontrolsüz hava girişli Tee-Parça • LAB/LAL Ταφ χωρίς θυρίδα επιθεώρησης με παροχή αέρα καύσης

Ø	Code Código Kod Κωδ.		a (mm)	b (mm)	c (mm)	d (mm)
	LAB	LAL				
60/100	APTZB5	APTZL5	100	62	90	150
80/125	APTZB8	APTZL8	125	62	90	150
100/150	-	APTZLX	150	62	100	170
110/160	APTZB1	APTZL1	160	62	100	170
125/180	APTZB2	APTZL2	180	62	120	190
160/225	APTZB6	APTZL6	225	62	150	220
200/300	APTZB0	APTZL0	300	62	150	220

## LAB/LAL Elbow 15°

LAB/LAL Bogen 15° • LAB/LAL Codo 15° • LAB/LAL DİRsek 15° • LAB/LAL Καμπύλη 15°

Ø	Code Código Kod Κωδ.		a (mm)	b (mm)	c (mm)	d (mm)
	LAB	LAL				
60/100	APBB15	APBL15	100	62	100	100
80/125	APBB18	APBL18	125	62	105	100
100/150	-	APBL1X	150	62	110	107
110/160	APBB11	APBL11	160	62	110	107
125/180	APBB12	APBL12	180	62	130	130
160/225	APBB16	APBL16	225	62	130	130
200/300	APBB10	APBL10	300	62	130	130

LAB

LAL

# EXTERNAL CONCENTRIC AIR-GAS FLUE SYSTEM

**LAB/LAL**

KONZENTRISCHES AUSSENWANDSYSTEM

LAB - PPH/stainless steel - polished

SISTEMA DE EVACUACIÓN CONCÉNTRICO PARA EL EXTERIOR

PPH/Edelstahl hochglanz · PPH/acero inoxidable pulido

EŞ MERKEZLİ KAPALI BACA SİSTEMİ

PPH/paslanmaz çelik - cilalı · PPH/ανοξειδωτος χάλυβας

ΟΜΟΚΕΝΤΡΙΚΟ ΣΥΣΤΗΜΑ ΚΑΠΝΟΔΟΧΟΥ ΕΣΩΤΕΡΙΚΗΣ ΧΡΗΣΗΣ

LAL - PPH/stainless steel-white powder coated

PPH/Edelstahl weiss pulverbeschichtet

PPH/acero inoxidable en epoxi blanco

PPH/paslanmaz çelik - beyaz toz boyalı

PPH/ανοξειδωτος χάλυβας - ηλεκτροστατική βαφή

**Ø60/100 – 200/300 mm**

## LAB/LAL Elbow 30°

LAB/LAL Bogen 30° · LAB/LAL Codo 30° · LAB/LAL Dirsek 30° · LAB/LAL Καμπύλη 30°

Ø	Code Código Kod Κωδ.		a (mm)	b (mm)	c (mm)	d (mm)
	LAB	LAL				
60/100	APBB35	APBL35	100	62	105	105
80/125	APBB38	APBL38	125	62	120	120
100/150	-	APBL3X	150	62	130	130
110/160	APBB31	APBL31	160	62	130	130
125/180	APBB32	APBL32	180	62	160	155
160/225	APBB36	APBL36	225	62	160	155
200/300	APBB30	APBL30	300	62	160	155

## LAB/LAL Elbow 45°

LAB/LAL Bogen 45° · LAB/LAL Codo 45° · LAB/LAL Dirsek 45° · LAB/LAL Καμπύλη 45°

Ø	Code Código Kod Κωδ.		a (mm)	b (mm)	c (mm)	d (mm)
	LAB	LAL				
60/100	APBB45	APBL45	100	62	135	140
80/125	APBB48	APBL48	125	62	135	140
100/150	-	APBL4X	150	62	150	155
110/160	APBB41	APBL41	160	62	150	155
125/180	APBB42	APBL42	180	62	170	160
160/225	APBB46	APBL46	225	62	195	190
200/300	APBB40	APBL40	300	62	195	190

## LAB/LAL Elbow 87°

LAB/LAL Bogen 87° · LAB/LAL Codo 87° · LAB/LAL Dirsek 87° · LAB/LAL Καμπύλη 87°

Ø	Code Código Kod Κωδ.		a (mm)	b (mm)	c (mm)	d (mm)
	LAB	LAL				
60/100	APBB95	APBL95	100	62	200	130
80/125	APBB98	APBL98	125	62	235	150
100/150	-	APBL9X	150	62	250	155
110/160	APBB91	APBL91	160	62	250	155
125/180	APBB92	APBL92	180	62	260	175
160/225	APBB96	APBL96	225	62	270	220
200/300	APBB90	APBL90	300	62	270	220

## LAB/LAL Base support bracket complete

LAB/LAL Wandkonsole komplett · LAB/LAL Base mural completa · LAB/LAL Taban destek braketi tamamlandı · LAB/LAL Καμπύλη στερέωσης 87° με βραχίονα στήριξης

Ø	Code Código Kod Κωδ.		a (mm)	b (mm)	c (mm)	d (mm)
	LAB	LAL				
60/100	APWKB5	APWKL5	100	125	260	155
80/125	APWKB8	APWKL8	125	175	290	220
100/150	-	APWKLX	150	150	360	220
110/160	APWKB1	APWKL1	160	150	360	220
125/180	APWKB2	APWKL2	180	160	390	225
160/225	APWKB6	APWKL6	-	-	-	-
200/300	APWKB0	APWKL0	-	-	-	-

LAB

LAL

# EXTERNAL CONCENTRIC AIR-GAS FLUE SYSTEM

**LAB/LAL**

KONZENTRISCHES AUSSENWANDSYSTEM

LAB - PPH/stainless steel - polished

SISTEMA DE EVACUACIÓN CONCÉNTRICO PARA EL EXTERIOR

PPH/Edelstahl hochglanz · PPH/acero inoxidable pulido

ΕΞ ΜΕΡΚΕΖΛΪ ΚΑΡΑΛΙ ΒΑΚΑ ΣΪΣΤΕΜΪ

PPH/paslanmaz çelik - cilalı · PPH/ανοξειδωτός χάλυβας

ΟΜΟΚΕΝΤΡΙΚΟ ΣΥΣΤΗΜΑ ΚΑΠΝΟΔΟΧΟΥ ΕΣΩΤΕΡΙΚΗΣ ΧΡΗΣΗΣ

LAL - PPH/stainless steel-white powder coated

PPH/Edelstahl weiss pulverbeschichtet

PPH/acero inoxidable en epoxi blanco

PPH/paslanmaz çelik - beyaz toz boyalı

PPH/ανοξειδωτός χάλυβας - ηλεκτροστατική βαφή

**Ø60/100 – 200/300 mm**

**LAB/LAL Support Elbow 87° with pipe**  
 LAB/LAL Stützbogen 87° m. Rohr • LAB/LAL Codo apoyo 87° con tubo • LAB/LAL Destek Dirseği 87° boru ile  
 • LAB/LAL Καμπύλη 87° με προέκταση

Ø	Code Código Kod Κωδ.		a (mm)	b (mm)	c (mm)	d (mm)
	LAB	LAL				
60/100	APSBB5	APSBL5	100	62	200	448
80/125	APSBB8	APSBL8	125	62	235	448
100/150	-	APSBLX	150	62	250	448
110/160	APSBB1	APSBL1	160	62	250	448
125/180	APSBB2	APSBL2	180	62	260	448
160/225	APSBB6	APSBL6	225	62	270	448
200/300	APSBB0	APSBL0	300	62	270	448

**LAB/LAL Roof terminal**  
 LAB/LAL Dachaufsatz • LAB/LAL Terminal vertical • LAB/LAL Çatı terminali • LAB/LAL Προέκταση οροφής με προστατευτικό βροχής

Ø	Code Código Kod Κωδ.		a (mm)	b (mm)	c (mm)	d (mm)
	LAB	LAL				
60/100	APDA45	APDL45	310	690	930	115
80/125	APDA48	APDL48	310	690	930	135
100/150	-	APDL4X	310	690	930	180
110/160	APDA41	APDL41	310	690	930	180
125/180	APDA42	APDL42	310	690	930	200
160/225	APDA46	APDL46	310	690	930	245
200/300	APDA40	APDL40	310	690	930	320

**LAB/LAL Socket (F) for cutted pipes**  
 LAB/LAL Muffe female z. Rohrkürzung • LAB/LAL Manguito (H) pr. tubos cortados • LAB/LAL Kesilmiş borular için soket (F)  
 • LAB/LAL Υποδοχή για κοπή σωλήνα

Ø	Code Código Kod Κωδ.		a (mm)	b (mm)	c (mm)	d (mm)
	LAB	LAL				
60/100	APMKB5	APMKL5	40	80	-	-
80/125	APMKB8	APMKL8	72	118	-	-
100/150	-	APMKLX	70	120	-	-
110/160	APMKB1	APMKL1	70	120	-	-
125/180	APMKB2	APMKL2	70	120	-	-
160/225	APMKB6	APMKL6	70	120	-	-
200/300	APMKB0	APMKL0	70	120	-	-

**LAB/LAL Top terminal with air intake**  
 LAB/LAL Mündungsabschluss m. Zuluft • LAB/LAL Terminal con entrada de aire • LAB/LAL Hava girişli üst terminal • LAB/LAL Άνοιγμα με αναρρόφηση

Ø	Code Código Kod Κωδ.		a (mm)	b (mm)	c (mm)	d (mm)
	LAB	LAL				
60/100	APMSB5	APMSL5	160	175	155	340
80/125	APMSB8	APMSL8	160	120	180	280
100/150	-	APMSLX	160	120	180	280
110/160	APMSB1	APMSL1	160	120	180	280
125/180	APMSB2	APMSL2	170	115	235	280
160/225	APMSB6	APMSL6	145	125	290	295
200/300	APMSB0	APMSL0	145	120	390	265

LAB  
LAL

# EXTERNAL CONCENTRIC AIR-GAS FLUE SYSTEM

KONZENTRISCHES AUSSENWANDSYSTEM

SISTEMA DE EVACUACIÓN CONCÉNTRICO PARA EL EXTERIOR

EŞ MERKEZLİ KAPALI BACA SİSTEMİ

ΟΜΟΚΕΝΤΡΙΚΟ ΣΥΣΤΗΜΑ ΚΑΠΝΟΔΟΧΟΥ ΕΣΩΤΕΡΙΚΗΣ ΧΡΗΣΗΣ

**Ø60/100 – 200/300 mm**

**LAB/LAL**

LAB - PPH/stainless steel – polished

PPH/Edelstahl hochglanz · PPH/acero inoxidable pulido

PPH/paslanmaz çelik - cilalı · PPH/ανοξειδωτος χάλυβας

LAL - PPH/stainless steel-white powder coated

PPH/Edelstahl weiss pulverbeschichtet

PPH/acero inoxidable en epoxi blanco

PPH/paslanmaz çelik - beyaz toz boyalı

PPH/ανοξειδωτος χάλυβας - ηλεκτροστατική βαφή

## LAB/LAL Clamp for connection reinforcement

LAB/LAL Sturmschelle · LAB/LAL Abrazadera refuerzo conexiones · LAB/LAL Bağlantı takviyesi için kelepçe · LAB/LAL Σφιγκτήρας για ενίσχυση σύνδεσης

	Ø	Code Código Kod Κωδ.		a (mm)	b (mm)	c (mm)	d (mm)
		LAB	LAL				
	60/100	APKLB5	APKLL5	105	105	-	-
	80/125	APKLB8	APKLL8	105	130	-	-
	100/150	-	APKLLX	105	155	-	-
	110/160	APKLB1	APKLL1	105	165	-	-
	125/180	APKLB2	APKLL2	105	185	-	-
	160/225	APKLB6	APKLL6	105	230	-	-
	200/300	APKLB0	APKLL0	105	305	-	-

## ZUB Universal roof flashing 5° - 55° UNI (complete)

ZUB Universal-Dachpfanne 5° - 55° UNI (komplett) · ZUB Salida techo universal 5° - 55° completa · ZUB Üiversal çatı flaşörü 5° - 55° UNI (komple) · ZUB Διάβαση στέγης καπνοδόχου 5° - 55° UNI (πλήρες)

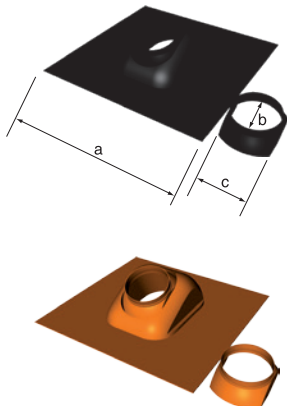
	Ø	Code Código Kod Κωδ.		a (mm)	b (mm)	c (mm)	i
		LAB	LAL				
	5° - 25°	60/100 - 80/125	ZUD02S	500	138	132	Plastic - black Kunststoff - schwarz Plástico negro Plastik - siyah Πλαστικό - μαύρο
		110/160	ZUD06S	700	165	180	
	5° - 45°	60/100 - 80/125	ZUD02T	500	138	132	Plastic - terracotta Kunststoff - terracotta Plástico terracota Plastik - terracota Πλαστικό - τερακότα
		110/160	ZUD06T	700	165	180	
	25° - 45°	60/100 - 80/125	ZUD22S	500	138	132	Plastic - black Kunststoff - schwarz Plástico negro Plastik - siyah Πλαστικό - μαύρο
		110/160	ZUD26S	700	165	180	
25° - 55°	60/100 - 80/125	ZUD22T	500	138	132	Plastic - terracotta Kunststoff - terracotta Plástico terracota Plastik - terracota Πλαστικό - τερακότα	
	110/160	ZUD26T	700	165	180		
35° - 55°	60/100 - 80/125	ZUD32S	500	138	132	Plastic - black Kunststoff - schwarz Plástico negro Plastik - siyah Πλαστικό - μαύρο	
	110/160	ZUD36S	700	165	180		
	60/100 - 80/125	ZUD32T	500	138	132	Plastic - terracotta Kunststoff - terracotta Plástico terracota Plastik - terracota Πλαστικό - τερακότα	
	110/160	ZUD36T	700	165	180		

## ZUB Roof flashing

ZUB Dachpfanne · ZUB Salida techo · ZUB Çatı flashingleri · ZUB Διάβαση στέγης καπνοδόχου

	Ø	Code Código Kod Κωδ.		a (mm)	b (mm)	i
		LAB	LAL			
	60/100 - 80/125	ALPP35	-	-	-	Plastic - black Kunststoff - schwarz · Plástico negro · Plastik - siyah · Πλαστικό - μαύρο χρώμα
	-	-	-	-	-	
	-	-	-	-	-	

# EXTERNAL CONCENTRIC AIR-GAS FLUE SYSTEM

KONZENTRISCHES AUSSENWANDSYSTEM

SISTEMA DE EVACUACIÓN CONCÉNTRICO PARA EL EXTERIOR

EŞ MERKEZLİ KAPALI BACA SİSTEMİ

ΟΜΟΚΕΝΤΡΙΚΟ ΣΥΣΤΗΜΑ ΚΑΠΝΟΔΟΧΟΥ ΕΣΩΤΕΡΙΚΗΣ ΧΡΗΣΗΣ

**Ø60/100 – 200/300 mm**

**LAB/LAL**

LAB - PPH/stainless steel – polished

PPH/Edelstahl hochglanz · PPH/acero inoxidable pulido

PPH/paslanmaz çelik - cilalı · PPH/ανοξειδωτος χάλυβας

LAL - PPH/stainless steel-white powder coated

PPH/Edelstahl weiss pulverbeschichtet

PPH/acero inoxidable en epoxi blanco

PPH/paslanmaz çelik - beyaz toz boyalı

PPH/ανοξειδωτος χάλυβας - ηλεκτροστατική βαφή

## LAB/LAL Wall bracket extension I

LAB/LAL Wandkonsolenverlängerung I • LAB/LAL Extensión base mural I • LAB/LAL Duvar braketi uzatması I • LAB/LAL Προέκταση βραχίονα στήριξης I

Ø	Code Código Kod Κωδ.		a (mm)	b (mm)	c (mm)	d (mm)
	LAB	LAL				
60/100	APW1B5	APW1L5	190	165	0-160	50-210
80/125	APW1B8	APW1L8	190	180	0-100	50-150
100/150	-	APW1LX	190	210	0-155	50-205
110/160	APW1B1	APW1L1	190	210	0-155	50-205
125/180	APW1B2	APW1L2	250	235	0-220	50-270
160/225	APW1B6	APW1L6	-	-	-	-
200/300	APW1B0	APW1L0	-	-	-	-

## LAB/LAL Wall bracket extension II

LAB/LAL Wandkonsolenverlängerung II • LAB/LAL Extensión base mural II • LAB/LAL Duvar braketi uzatması II • LAB/LAL Προέκταση βραχίονα στήριξης II

Ø	Code Código Kod Κωδ.		a (mm)	b (mm)	c (mm)	d (mm)
	LAB	LAL				
60/100	APW2B5	APW2L5	90	165	100-245	150-295
80/125	APW2B8	APW2L8	90	180	100-185	150-235
100/150	-	APW2LX	120	210	120-185	170-235
110/160	APW2B1	APW2L1	120	210	120-185	170-235
125/180	APW2B2	APW2L2	-	-	-	-
160/225	APW2B6	APW2L6	-	-	-	-
200/300	APW2B0	APW2L0	-	-	-	-

## LAB/LAL Wall bracket extension III

LAB/LAL Wandkonsolenverlängerung III • LAB/LAL Extensión base mural III • LAB/LAL Duvar braketi uzatması III • LAB/LAL Προέκταση βραχίονα στήριξης III

Ø	Code Código Kod Κωδ.		a (mm)	b (mm)	c (mm)	d (mm)
	LAB	LAL				
60/100	APW3B5	APW3L5	165	165	180-280	230-330
80/125	APW3B8	APW3L8	170	170	180-280	230-330
100/150	-	APW3LX	180	165	180-280	230-330
110/160	APW3B1	APW3L1	180	165	180-280	230-330
125/180	APW3B2	APW3L2	225	210	175-340	225-390
160/225	APW3B6	APW3L6	-	-	-	-
200/300	APW3B0	APW3L0	-	-	-	-

## LAB/LAL Wall bracket (reinforced)

LAB/LAL Wandhalterung (verstärkt) • LAB/LAL Soporte mural reforzado • LAB/LAL Duvar braketi (güçlendirilmiş) • LAB/LAL Στήριγμα τοίχου (ενισχυμένο)

Ø	Code Código Kod Κωδ.		a (mm)	b (mm)	c (mm)	d (mm)
	LAB	LAL				
60/100	APWHB5	APWHL5	100	150	230	45
80/125	APWHB8	APWHL8	125	175	225	45
100/150	-	APWHLX	150	215	295	50
110/160	APWHB1	APWHL1	160	215	295	50
125/180	APWHB2	APWHL2	180	230	245	50
160/225	APWHB6	APWHL6	225	270	285	50
200/300	APWHB0	APWHL0	300	350	360	50

LAB

LAL

# EXTERNAL CONCENTRIC AIR-GAS FLUE SYSTEM

**LAB/LAL**

KONZENTRISCHES AUSSENWANDSYSTEM

LAB - PPH/stainless steel - polished

SISTEMA DE EVACUACIÓN CONCÉNTRICO PARA EL EXTERIOR

PPH/Edelstahl hochglanz · PPH/acero inoxidable pulido

EŞ MERKEZLİ KAPALI BACA SİSTEMİ

PPH/paslanmaz çelik - cilalı · PPH/ανοξειδωτος χάλυβας

ΟΜΟΚΕΝΤΡΙΚΟ ΣΥΣΤΗΜΑ ΚΑΠΝΟΔΟΧΟΥ ΕΣΩΤΕΡΙΚΗΣ ΧΡΗΣΗΣ

LAL - PPH/stainless steel-white powder coated

**Ø60/100 – 200/300 mm**

PPH/Edelstahl weiss pulverbeschichtet

PPH/acero inoxidable en epoxi blanco

PPH/paslanmaz çelik - beyaz toz boyalı

PPH/ανοξειδωτος χάλυβας - ηλεκτροστατική βαφή

## LAB/LAL Wall bracket extension (reinforced)

LAB/LAL Verlängerung der Wandhalterung (verstärkt) · LAB/LAL Extensión soporte mural · LAB/LAL Duvar braketi uzatması (güçlendirilmiş) · LAB/LAL Προέκταση στηρίγματος τοίχου (ενισχυμένο)

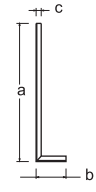
		Ø	Code Código Kod Κωδ.		a (mm)	b (mm)	c (mm)	d (mm)
			LAB	LAL				
		60/100	APVUBU	APVULU	395	85	15	-
		80/125						
		100/150						
		110/160						
		125/180						
		160/225						
		200/300						

## LAB/LAL One-piece cover plate

LAB/LAL Abdeckblende · LAB/LAL Remate mural · LAB/LAL Tek parça kapak plakası · LAB/LAL Πλάκα κάλυψης ενός τμήματος

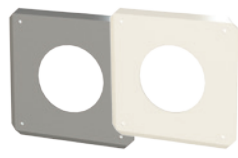
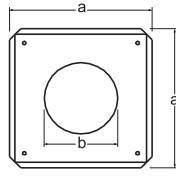
		Ø	Code Código Kod Κωδ.		a (mm)	b (mm)	c (mm)	d (mm)
			LAB	LAL				
		60/100	LPWB05	LPWL05	250	103	-	-
		80/125	LPWB08	LPWL08	250	128	-	-
		100/150	-	LPWL0X	250	155	-	-
		110/160	LPWB01	LPWL01	250	165	-	-
		125/180	LPWB02	LPWL02	400	182	-	-
		160/225	LPWB06	LPWL06	400	227	-	-
		200/300	LPWB00	LPWL00	-	-	-	-

## LAB/LAL Two-piece cover plate

LAB/LAL Abdeckblende 2-teilig · LAB/LAL Remate mural seccionado · LAB/LAL İki parçalı kapak plakası · LAB/LAL Πλάκα κάλυψης δύο τμημάτων

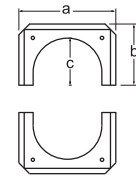
		Ø	Code Código Kod Κωδ.		a (mm)	b (mm)	c (mm)	d (mm)
			LAB	LAL				
		60/100	LPW2B5	LPW2L5	160	115	85	-
		80/125	LPW2B8	LPW2L8	180	145	120	-
		100/150	-	LPW2LX	230	155	130	-
		110/160	LPW2B1	LPW2L1	230	165	130	-
		125/180	LPW2B2	LPW2L2	-	-	-	-
		160/225	LPW2B6	LPW2L6	-	-	-	-
		200/300	LPW2B0	LPW2L0	-	-	-	-

## Adapter LIB/LIL on LAB/LAL

LAB/LAL Muffenwechsel m. kon. Sicke m/m · Adaptador LIB/LIL a LAB/LAL · LAB/LAL üzerinde LIB/LIL Adaptörü · Προσ/γέας LIB/LIL σε LAB/LAL

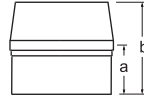
		Ø	Code Código Kod Κωδ.		a (mm)	b (mm)	c (mm)	d (mm)
			LAB	LAL				
		60/100	APSKB5	APSKL5	60	100	-	-
		80/125	APSKB8	APSKL8	80	126	-	-
		100/150	-	APSKLX	80	126	-	-
		110/160	APSKB1	APSKL1	80	126	-	-
		125/180	APSKB2	APSKL2	80	126	-	-
		160/225	APSKB6	APSKL6	80	126	-	-
		200/300	APSKB0	APSKL0	80	126	-	-

## Adapter LAB/LAL on LIB/LIL

LAB/LAL Muffenwechsel Dachaufsatz · Adaptador LAB/LAL a LIB/LIL · LIB/LIL üzerinde LAB/LAL Adaptörü · Προσ/γέας LAB/LAL σε LIB/LIL

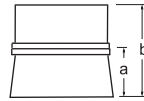
		Ø	Code Código Kod Κωδ.		a (mm)	b (mm)	c (mm)	d (mm)
			LAB	LAL				
		60/100	APDMB5	APDML5	60	100	-	-
		80/125	APDMB8	APDML8	80	126	-	-
		100/150	-	APDMLX	80	126	-	-
		110/160	APDMB1	APDML1	80	126	-	-
		-	-	-	-	-	-	-
		-	-	-	-	-	-	-
		-	-	-	-	-	-	-

# EXTERNAL CONCENTRIC AIR-GAS FLUE SYSTEM

KONZENTRISCHES AUSSENWANDSYSTEM

SISTEMA DE EVACUACIÓN CONCÉNTRICO PARA EL EXTERIOR

EŞ MERKEZLİ KAPALI BACA SİSTEMİ

ΟΜΟΚΕΝΤΡΙΚΟ ΣΥΣΤΗΜΑ ΚΑΠΝΟΔΟΧΟΥ ΕΣΩΤΕΡΙΚΗΣ ΧΡΗΣΗΣ

**Ø60/100 – 200/300 mm**

**LAB/LAL**

LAB - PPH/stainless steel – polished

PPH/Edelstahl hochglanz · PPH/acero inoxidable pulido

PPH/paslanmaz çelik - cilalı · PPH/ανοξειδωτος χάλυβας

LAL - PPH/stainless steel-white powder coated

PPH/Edelstahl weiss pulverbeschichtet

PPH/acero inoxidable en epoxi blanco

PPH/paslanmaz çelik - beyaz toz boyalı

PPH/ανοξειδωτος χάλυβας - ηλεκτροστατική βαφή

Instructions for anchoring chimney	Höhenmasse Aussenwandsystem	Medidas de altura del sistema para el exterior	Talimatlar için baca ankraji	Οδηγίες στερέωσης καμινάδας
<p><b>Above the last LAB wall bracket (reinforced) must be each connection clamped by a LAB clamp for connection reinforcement.</b></p> <p>Nach dem letzten Wandhalter jede Verbindung mit Rohrschelle sichern.</p> <p>Después del último soporte de pared, asegurar cada conexión con una abrazadera refuerzo conexiones.</p> <p>Son LAB duvar braketinin üstünde (güçlendirilmiş) her bir bağlantı, bağlantı için bir LAB kelepçesi ile kelepçelenmiştir takviye.</p> <p>Πάνω από το τελευταίο στήριγμα τοίχου LAB (ενισχυμένο) πρέπει σε κάθε σύνδεση να τοποθετείται ένας σφιγκτήρας LAB για ενίσχυση σύνδεσης.</p>				<p><b>Free length of the chimney above the last LAB wall bracket (reinforced) may be a maximum of 3 m.</b></p> <p>Freie Länge nach dem letzten Wandhalter bis zum Mündungsabschluss maximal 3m.</p> <p>Longitud libre después del último soporte de pared hasta la salida del terminal máximo 3m.</p> <p>Son LAB duvar braketinin üstünde (güçlendirilmiş) her bir bağlantı, bağlantı için bir LAB kelepçesi ile kelepçelenmiştir takviye.</p> <p>Το ελεύθερο μήκος της καπνοδόχου πάνω από το τελευταίο στήριγμα τοίχου LAB (ενισχυμένο) μπορεί να είναι ένα μέγιστο 3 m.</p>
				<p><b>Connection before the last LAB wall bracket (reinforced) must be clamped by a LAB clamp for connection reinforcement.</b></p> <p>Vor dem letzten Wandhalter ist eine Rohrschelle anzubringen.</p> <p>Se debe colocar una abrazadera refuerzo conexiones delante del último soporte de pared.</p> <p>Son LAC duvar braketinden önceki bağlantı (güçlendirilmiş) bağlantı için bir LAB kelepçesi ile kelepçelenmelidir takviye.</p> <p>Πριν από το τελευταίο στήριγμα τοίχου LAB (ενισχυμένο) πρέπει να τοποθετηθεί ένας σφιγκτήρας LAB για ενίσχυση σύνδεσης.</p>
				<p><b>Distance between two LAB wall brackets (reinforced) may be a maximum of 4 m.</b></p> <p>Maximale Aufbauhöhe zwischen 2 Wandhaltern darf nicht mehr als 4m betragen.</p> <p>La altura máxima de instalación entre 2 soportes de pared no debe superar los 4m.</p> <p>İki LAB duvar braketi (güçlendirilmiş) arasındaki mesafe maksimum 4 m.</p> <p>Η απόσταση μεταξύ δύο στηριγμάτων τοίχου LAB (ενισχυμένο) μπορεί να είναι το μέγιστο 4 m.</p>
				<p><b>First LAB wall bracket (reinforced) must be installed on LAB elbow 87°.</b></p> <p>Der 1. Wandhalter ist am Stützbogen zu montieren.</p> <p>El primer soporte de pared debe montarse en el codo de apoyo.</p> <p>İlk LAB duvar braketi (güçlendirilmiş) 87° LAB dirseğine takılmalıdır.</p> <p>Το πρώτο στήριγμα τοίχου LAB (ενισχυμένο) πρέπει να εγκατασταθεί στην καμπύλη LAB 87°.</p>
				<p><b>Structural height of the chimney where connections do not have to be clamped with LAB clamps for connection reinforcement.</b></p> <p>Aufbau bis letzten Wandhalter ohne Rohrschelle möglich.</p> <p>Altura estructural de la chimenea donde las conexiones no tienen que ser aseguradas con abrazaderas refuerzo conexiones.</p> <p>Bağlantıların olduğu yerde bacanın yapısal yüksekliği LAB kelepçeleri ile kelepçelenmesi gerekmez bağlantı takviyesi için.</p> <p>Δομικό ύψος της καμινάδας όπου οι συνδέσεις δεν χρειάζεται να στερεώνονται με σφιγκτήρες LAB για ενίσχυση σύνδεσης.</p>
				<p><b>Above the last LAB wall bracket (reinforced) must be each connection clamped by a LAB clamp for connection reinforcement.</b></p>

1	APMSB5
2	APWHB5
3	APRZB5
4	APSBB5
5	APKLB5
6	APRB15
7	LPWB05

LAB  
LAL

# EXTERNAL CONCENTRIC AIR-GAS FLUE SYSTEM

KONZENTRISCHES AUSSENWANDSYSTEM

SISTEMA DE EVACUACIÓN CONCÉNTRICO PARA EL EXTERIOR

EŞ MERKEZLİ KAPALI BACA SİSTEMİ

ΟΜΟΚΕΝΤΡΙΚΟ ΣΥΣΤΗΜΑ ΚΑΠΝΟΔΟΧΟΥ ΕΣΩΤΕΡΙΚΗΣ ΧΡΗΣΗΣ

**Ø60/100 – 200/300 mm**

**LAB/LAL**

LAB - PPH/stainless steel – polished

PPH/Edelstahl hochglanz · PPH/acero inoxidable pulido

PPH/paslanmaz çelik - cilalı · PPH/ανοξειδωτος χάλυβας

LAL - PPH/stainless steel-white powder coated

PPH/Edelstahl weiss pulverbeschichtet

PPH/acero inoxidable en epoxi blanco

PPH/paslanmaz çelik - beyaz toz boya

PPH/ανοξειδωτος χάλυβας - ηλεκτροστατική βαφή

## Exchangeability of LAB tee with inspection door lids.

Aus LAB Revisions-T wird LAB Revisions-T mit Zuluft.

LAB Te-inspección se convierte en LAB Te-inspección con entrada de aire

Değiştirilebilirlik ile LAB tizörtünün muayene kapısı kapakları.

Εναλλαξιμότητα καπακιών σε ταφ με θυρίδα επιθεώρησης LAB.

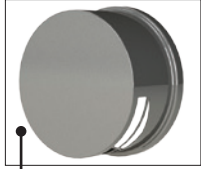

### LAB lid with air supply grille.

LAB Deckel mit Zuluftgitter.

LAB Tapa con rejilla entrada de aire.

LAB hava besleme ızgaralı kapak.

LAB καπάκι με γρίλια για παροχή αέρα.



or  
oder  
o  
veya  
ή

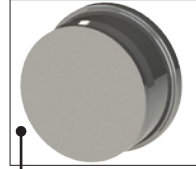

### LAB lid solid

LAB Deckel geschlossen.

LAB Tapa cerrada.

LAB kapak katı.

LAB καπάκι χωρίς γρίλια για παροχή αέρα.



## Assembly of LAB/LAL extended wall bracket.

Montage LAB/LAL Wandkonsolenverlängerung.

Montaje de LAB/LAL extensión base mural.

LAB/LAL Montajı uzatılmış duvar braketi.

Τοποθέτηση Προέκταση βραχίονα στήριξης LAB/LAL.



### LAB/LAL wall bracket extension I, 50-150 mm (one part).

LAB/LAL Wandkonsolenverlängerung I, 50-150 mm (1 Bauteil).

LAB/LAL Extensión base mural I, 50-150 mm (1 componente).

LAB/LAL Duvar braketi uzatma I, 50-150 mm (1 bileşen).

LAB/LAL Προέκταση βραχίονα στήριξης I, 50-150 mm (ένα τεμάχιο).

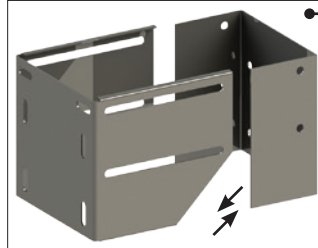

### LAB/LAL wall bracket extension II, 130-250 mm (two parts).

LAB/LAL Wandkonsolenverlängerung II, 130-250 mm (2 Bauteile).

LAB/LAL Extensión base mural II, 130-250 mm (2 componentes).

LAB/LAL Destek kolu uzatması II, 130-250 mm (iki parça).

LAB/LAL Προέκταση βραχίονα στήριξης II, 130-250 mm (δύο τεμάχια).

Connect and screw together at the desired distance.

Auf benötigte Distanz ineinander schieben und verschrauben.

Conectar y atornillar a la distancia deseada.

Bağlayın ve vidalayın birlikte istenen mesafe.

Συνδέστε και βιδώστε μαζί στην επιθυμητή απόσταση.

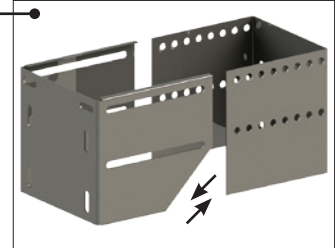

### LAB/LAL wall bracket extension III, 220-330 mm (two parts).

LAB/LAL Wandkonsolenverlängerung III, 220-330 mm (2 Bauteile).

LAB/LAL Extensión base mural III, 220-330 mm (2 componentes).

LAB/LAL Duvar braketi uzatması III, 220-330 mm (2 bileşen)..

LAB/LAL Προέκταση βραχίονα στήριξης III, 220-330 mm (δύο τεμάχια).

## Assembly of LAB/LAL wall bracket with wall bracket extension.

Montage des LAB/LAL Wandhalters mit der Wandhalterverlängerung.

Montaje del LAB/LAL soporte mural con la extensión del soporte.

LAB/LAL Montajı duvar ile duvar braketi dirsek uzantısı.

Τοποθέτηση προέκτασης στηρίγματος τοίχου στήριξης LAB/LAL.

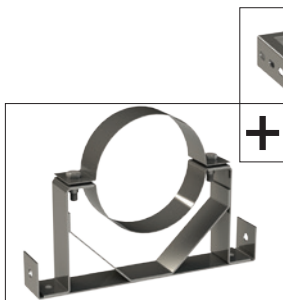

Connect and screw together at the desired distance.

Auf benötigte Distanz ineinander schieben und verschrauben.

Conectar y atornillar a la distancia deseada.

Bağlayın ve birbirine vidalayın istenen mesafede.

Συνδέστε και βιδώστε μαζί στην επιθυμητή απόσταση.

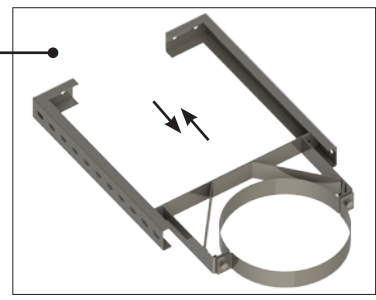

# EXTERNAL CONCENTRIC AIR-GAS FLUE SYSTEM

**LAB/LAL**

KONZENTRISCHES AUSSENWANDSYSTEM

SISTEMA DE EVACUACIÓN CONCÉNTRICO PARA EL EXTERIOR

EŞ MERKEZLİ KAPALI BACA SİSTEMİ

ΟΜΟΚΕΝΤΡΙΚΟ ΣΥΣΤΗΜΑ ΚΑΠΝΟΔΟΧΟΥ ΕΣΩΤΕΡΙΚΗΣ ΧΡΗΣΗΣ

**Ø60/100 – 200/300 mm**

LAB - PPH/stainless steel – polished

PPH/Edelstahl hochglanz · PPH/acero inoxidable pulido

PPH/paslanmaz çelik - cilalı · PPH/ανοξειδωτος χάλυβας

LAL - PPH/stainless steel-white powder coated

PPH/Edelstahl weiss pulverbeschichtet

PPH/acero inoxidable en epoxi blanco

PPH/paslanmaz çelik - beyaz toz boyalı

PPH/ανοξειδωτος χάλυβας - ηλεκτροστατική βαφή

## Assembly instruction of adaptor LIB/LIL to LAB/LAL.

Montageanleitung des Adapters LIB/LIL auf LAB/LAL

Instrucciones de montaje del adaptador LIB/LIL a LAB/LAL.

LIB/LIL adaptörünü LAB /LAL'e kurma yöntemi.

Μέθοδος εγκατάστασης του προσαρμογέα LIB/LIL σε LAB /LAL.



### LAB/LAL socket

LAB/LAL Muffe  
LAB/LAL Manguito  
LAL LAB/LAL soketi  
LAB/LAL υποδοχή



### Adapter LIB/LIL on LAB/LAL

Adapter LIB/LIL auf LAB/LAL  
Adaptador LIB/LIL a LAB/LAL  
LAB/LAL üzerinde LIB/LIL Adaptörü  
Προσ/γέας LIB/LIL σε LAB/LAL



### LIB/LIL socket

LIB/LIL Muffe  
LIB/LIL Manguito  
LIB/LIL soketi  
LIB/LIL υποδοχή

## Assembly instruction of adaptor LAB/LAL to LIB/LIL.

Montageanleitung des Adapters LAB/LAL auf LIB/LIL

Instrucciones de montaje del adaptador LAB/LAL a LIB/LIL.

LAB/LAL'i LIB/LIL'e uyarlamak için talimatlar.

Μέθοδος εγκατάστασης του προσαρμογέα LAB/LAL σε LIB/LIL

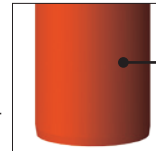

### LIB/LIL pipe

LIB/LIL Rohr  
LIB/LIL Tubo  
LIB/LIL boru  
LIB/LIL σωλήνα



### Adapter LAB/LAL on LIB/LIL

Adapter LAB/LAL auf LIB/LIL  
Adaptador LAB/LAL a LIB/LIL  
LIB/LIL üzerinde LAB/LAL Adaptörü  
Προσ/γέας LAB/LAL σε LIB/LIL



### LAB/LAL Sickle

LAB/LAL Sicke  
LAB/LAL-Ondulación  
LAB/LAL Sicke  
LAB/LAL αρσενική υποδοχή

## Recommended length of deflections

Empfohlene Länge der Abwinklungen  
• Longitud recomendada de las desviaciones  
• Önerilen sarpma uzunluğu • Συνιστώμενο μήκος εκτροπών

**Elbow 15°**  
Bogen 15° • Codo 15°  
Dirsek 15° • Καμπύλη 15°

**Elbow 30°**  
Bogen 30° • Codo 30°  
Dirsek 30° • Καμπύλη 30°

**Elbow 45°**  
Bogen 45° • Codo 45°  
Dirsek 45° • Καμπύλη 45°

Ø		60/100	80/125	110/160	60/100	80/125	110/160	60/100	80/125	110/160
<b>Length of the element</b> Länge des Elements Longitud del elemento Elemenar uzunluğu Μήκος ενδιάμεσου σωλήνα	<b>Without straight part</b> Ohne gerades Stück Sin tramo recto Düz parça olmadan Χωρίς ευθύγραμμο τμήμα	35	35	40	75	90	100	150	150	170
	250 mm	85	85	90	170	185	195	285	285	305
	500 mm	150	150	155	295	310	320	460	460	480
	1000 mm	280	280	285	545	560	570	815	815	835

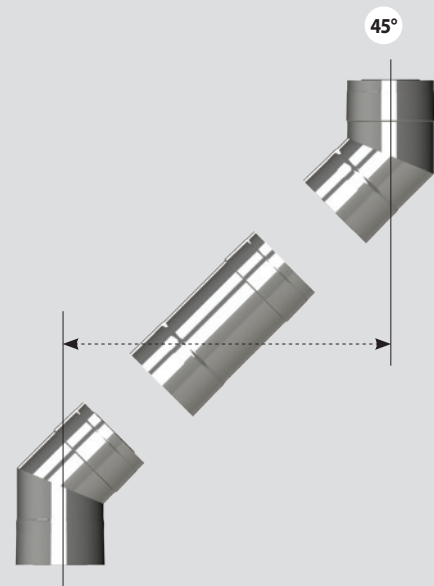
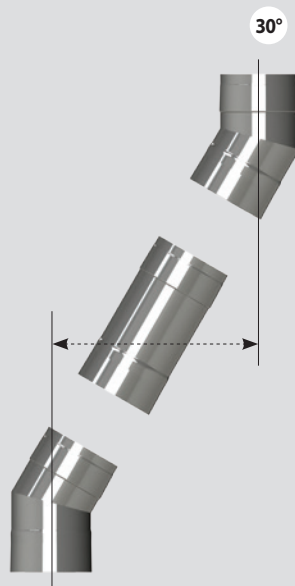
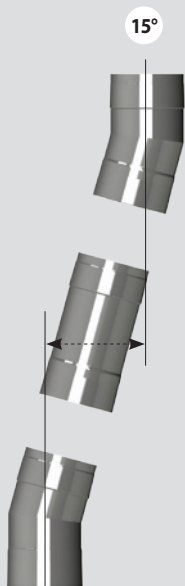

LAB

LAL

# EXTERNAL CONCENTRIC AIR-GAS FLUE SYSTEM

KONZENTRISCHES AUSSENWANDSYSTEM

SISTEMA DE EVACUACIÓN CONCÉNTRICO PARA EL EXTERIOR

HARÍCI KONSANTRIK HAVA-GAZ BACA SİSTEMİ

ΟΜΟΚΕΝΤΡΙΚΟ ΣΥΣΤΗΜΑ ΚΑΠΝΟΔΟΧΟΥ ΕΣΩΤΕΡΙΚΗΣ ΧΡΗΣΗΣ

**Ø60/100 – 200/300 mm**

**LAM**

PPH/stainless steel – matt

PPH/Edelstahl matt

PPH/acero inoxidable mate

PPH/paslanmaz çelik - mat

PPH/ανοξειδωτος χάλυβας – ματ

1	APMSM5
2	APRM15
3	APWHM5
4	APVUMU
5	APRZM5
6	APBM95
7	LPWM05

LAM			
Ø (mm)	Inner dimension of socket Innenmass des Rohres Dimensión interior del tubo Soketin iç boyutu Εσωτερική διατομή υποδοχής (mm)	Wall thickness Wandstärke Espesor de pared Duvar kalınlığı Πάχος τοιχώματος (mm)	Outer dimension of socket Ausßenmass der Muffe Dimensión exterior del manguito Soketin dış boyutu Εξωτερική διατομή υποδοχής (mm)
60/100	105	0,6	106,2
80/125	128	0,6	129,2
110/160	163	0,6	164,2
125/150	182,6	0,6	183,2
160/225	228	0,6	229,2
200/300	301,6	0,6	302,8

**When assembling horizontal piping, it is necessary to create a slope towards the boiler at minimum of 3°.**

Gefälle schaffen waagerechte Verbindungsleitung muss zum Kessel immer ein Gefälle von mindestens 3° haben.

Al montar las tuberías horizontales, es necesario crear una pendiente hacia la caldera de un mínimo de 3°.

Yatay boru tesisatını monte ederken, kazana doğru en az 3°'lik bir eğim oluşturmak gerekir.

Κατά την εγκατάσταση οριζόντιων σωληνώσεων, πρέπει να υπάρχει κλίση προς τον λέβητα τουλάχιστον 3°.

LAM

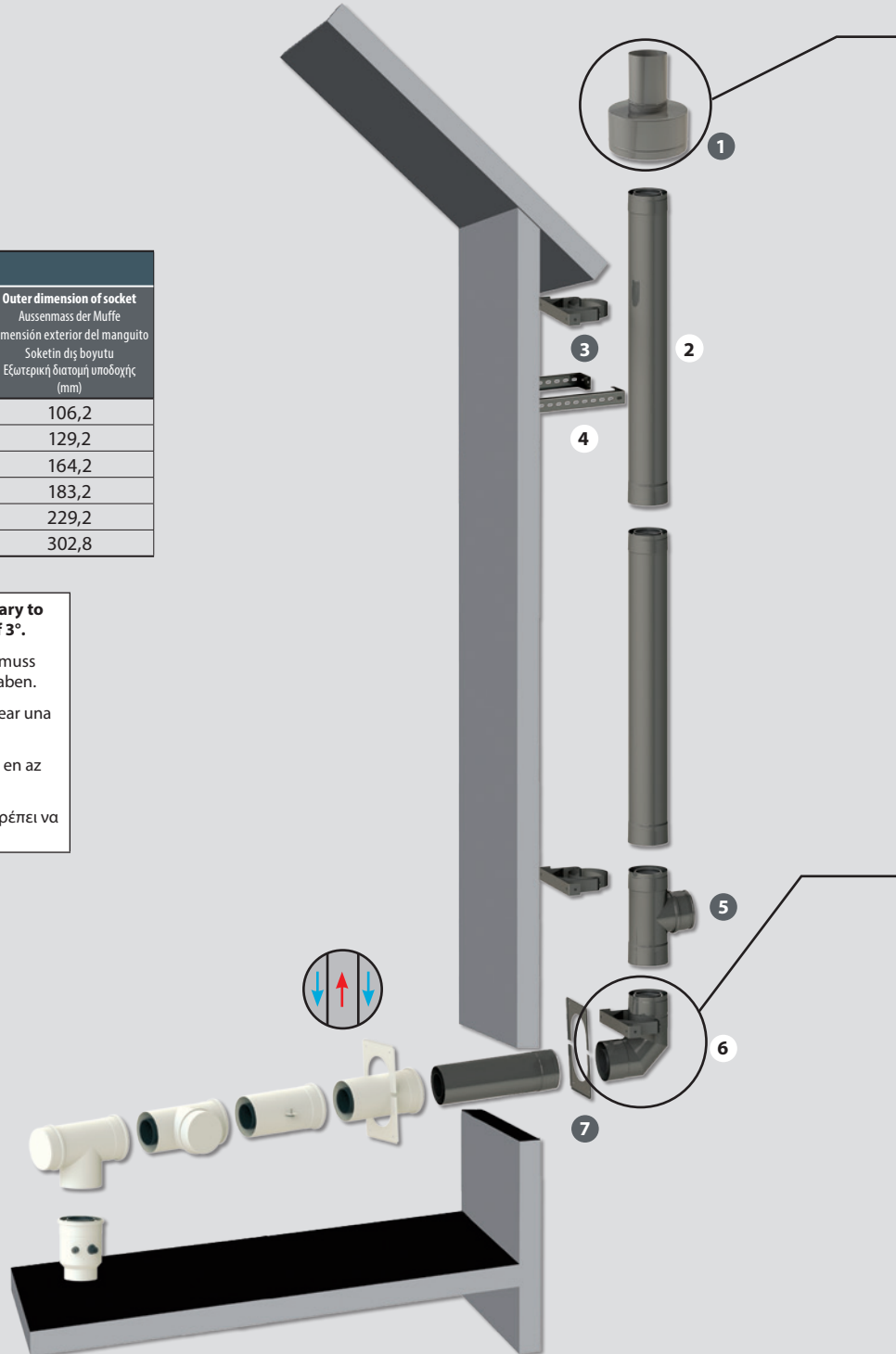

# EXTERNAL CONCENTRIC AIR-GAS FLUE SYSTEM

KONZENTRISCHES AUSSENWANDSYSTEM

SISTEMA DE EVACUACIÓN CONCÉNTRICO PARA EL EXTERIOR

HARİCİ KONSANTRİK HAVA-GAZ BACA SİSTEMİ

ΟΜΟΚΕΝΤΡΙΚΟ ΣΥΣΤΗΜΑ ΚΑΠΝΟΔΟΧΟΥ ΕΣΩΤΕΡΙΚΗΣ ΧΡΗΣΗΣ

**Ø60/100 – 200/300 mm**

**LAM**

PPH/stainless steel – matt

PPH/Edelstahl matt

PPH/acero inoxidable mate

PPH/paslanmaz çelik - mat

PPH/ανοξειδωτος χάλυβας – ματ



**Insert LAM opening with suction into the last pipe with socket.**

LAM Mündungsrohr in letzte PPH-Muffe einstecken

Insertar el tubo del LAM terminal con entrada de aire en el manguito del último tubo PPH.

LAM açıklığını yerleştirin içine emme ile soketli son boru.

Εισάγετε το άνοιγμα LAM με αναρρόφηση στον τελευταίο σωλήνα με υποδοχή.

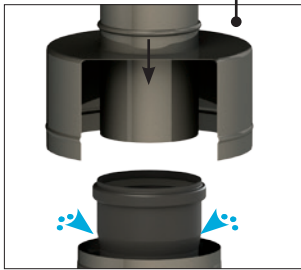

**LAM tee with inspection door with air supply enables suction of combustion air.**

Verbrennungsluft wird durch LAM Revisions-T mit Zuluft angesaugt.

La LAM Te-inspección con entrada de aire permite la aspiración del aire de combustión.

Denetimli LAM tışört hava beslemeli kapı etkinleştirir yanma havasının emilmesi.

Ταφ με θυρίδα επιθεώρησης LAM και παροχή αέρα που επιτρέπει την αναρρόφηση του αέρα καύσης.

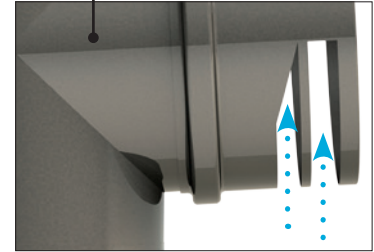
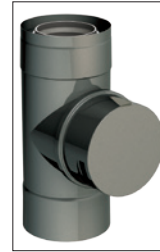

**Combination of LAM elbow 87° with wall bracket (reinforced) and LAM pipe.**

Kombination aus LAM Stützbogen mit Wandkonsole (verstärkt) und LAM Rohr.

Combinación de LAM codo de apoyo 87° con soporte pared (reforzado) y LAM Tubo.

LAM dirsek 87° ile duvar braketi (güçlendirilmiş) ve LAM boru ile kombinasyonu.

Συνδυασμός καμπύλης 87° με στήριγμα τοίχου LAM (ενισχυμένο).

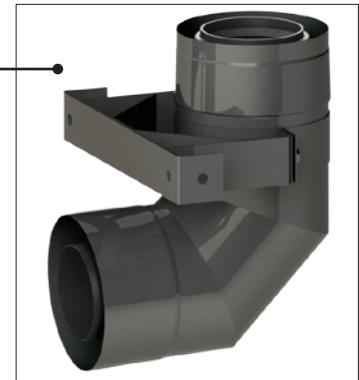
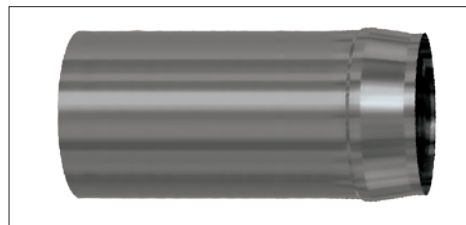

LAM

**Assembly instruction of adaptor LIB/LIL to LAM.**

Montageanleitung des Adapters LIB/LIL auf LAM.

Instrucciones de montaje del adaptador LIB/LIL a LAM.

LIB/LIL - LAM adaptörünün montaj talimatı.

Μέθοδος εγκατάστασης του προσ/γέα LIB/LIL σε LAM.

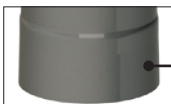

**LAM Socket**  
LAM Muffe  
LAM Manguito  
LAM Soket  
LAM υποδοχή



**Adapter LIB/LIL on LAM**  
Adapter LIB/LIL auf LAM  
Adaptador LIB/LIL a LAM  
LAM üzerinde LIB/LIL Adaptörü  
Προσ/γέας LIB/LIL σε LAM



**LIB/LIL Socket**  
LIB/LIL Muffe  
LIB/LIL Manguito  
LIB/LIL Soket  
LIB/LIL υποδοχή

**Assembly instruction of adaptor LAM to LIB/LIL.**

Montageanleitung des Adapters LAM auf LIB/LIL.

Instrucciones de montaje del adaptador LAM a LIB/LIL.

LAM adaptörünün LIB/LIL'e montaj talimatı.

Μέθοδος εγκατάστασης του προσ/γέα LAM σε LIB/LIL.



**LIB/LIL Pipe**  
LIB/LIL Rohr  
LIB/LIL Tubo  
LIB/LIL Boru  
LIB/LIL σωλήνα



**Adapter LAM on LIB/LIL**  
Adapter LAM auf LIB/LIL  
Adaptador LAM a LIB/LIL  
LIB/LIL üzerinde LAM Adaptörü  
Προσ/γέας LAM σε LIB/LIL



**LAM-Sicke**  
LAM Sicke  
LAM-Ondulación  
LAM-Sicke  
LAM αρσενική υποδοχή

# EXTERNAL CONCENTRIC AIR-GAS FLUE SYSTEM

KONZENTRISCHES AUSSENWANDSYSTEM

SISTEMA DE EVACUACIÓN CONCÉNTRICO PARA EL EXTERIOR

HARİCİ KONSANTRİK HAVA-GAZ BACA SİSTEMİ

ΟΜΟΚΕΝΤΡΙΚΟ ΣΥΣΤΗΜΑ ΚΑΠΝΟΔΟΧΟΥ ΕΣΩΤΕΡΙΚΗΣ ΧΡΗΣΗΣ

**Ø60/100 – 110/160 mm**

**LAC**

PPH/stainless steel – copper coated

PPH/Edelstahl kupferbeschichtet

PPH/acero inoxidable cobreado

PPH/paslanmaz çelik - bakır kaplı

PPH/ανοξειδωτος χάλυβας – χαλκός

1	APMSC5
2	APRC15
3	APWHC5
4	APVUCU
5	APRZC5
6	APSBC5
7	LPWC05

LAC			
Ø (mm)	Inner dimension of socket Innenmass des Rohres Dimensión interior del tubo Soketin iç boyutu Εσωτερική διάσταση υποδοχής (mm)	Wall thickness Wandstärke Espesor de pared Duvar kalınlığı Πάχος τοιχώματος (mm)	Outer dimension of socket Ausßenmass der Muffe Dimensión exterior del manguito Soketin dış boyutu Εξωτερική διάσταση υποδοχής (mm)
60/100	105	0,6	106,2
80/125	128	0,6	129,2
110/160	163	0,6	164,2
125/150	182,6	0,6	183,2
160/225	228	0,6	229,2
200/300	301,6	0,6	302,8

**When assembling horizontal piping, it is necessary to create a slope towards the boiler at minimum of 3°.**

Gefälle schaffen waagerechte Verbindungsleitung muss zum Kessel immer ein Gefälle von mindestens 3° haben.

Al montar las tuberías horizontales, es necesario crear una pendiente hacia la caldera de un mínimo de 3°.

Yatay boru tesisatını monte ederken, kazana doğru en az 3°'lik bir eğim oluşturmak gerekir.

Κατά την εγκατάσταση οριζόντιων σωληνώσεων, πρέπει να υπάρχει κλίση προς τον λέβητα τουλάχιστον 3°.

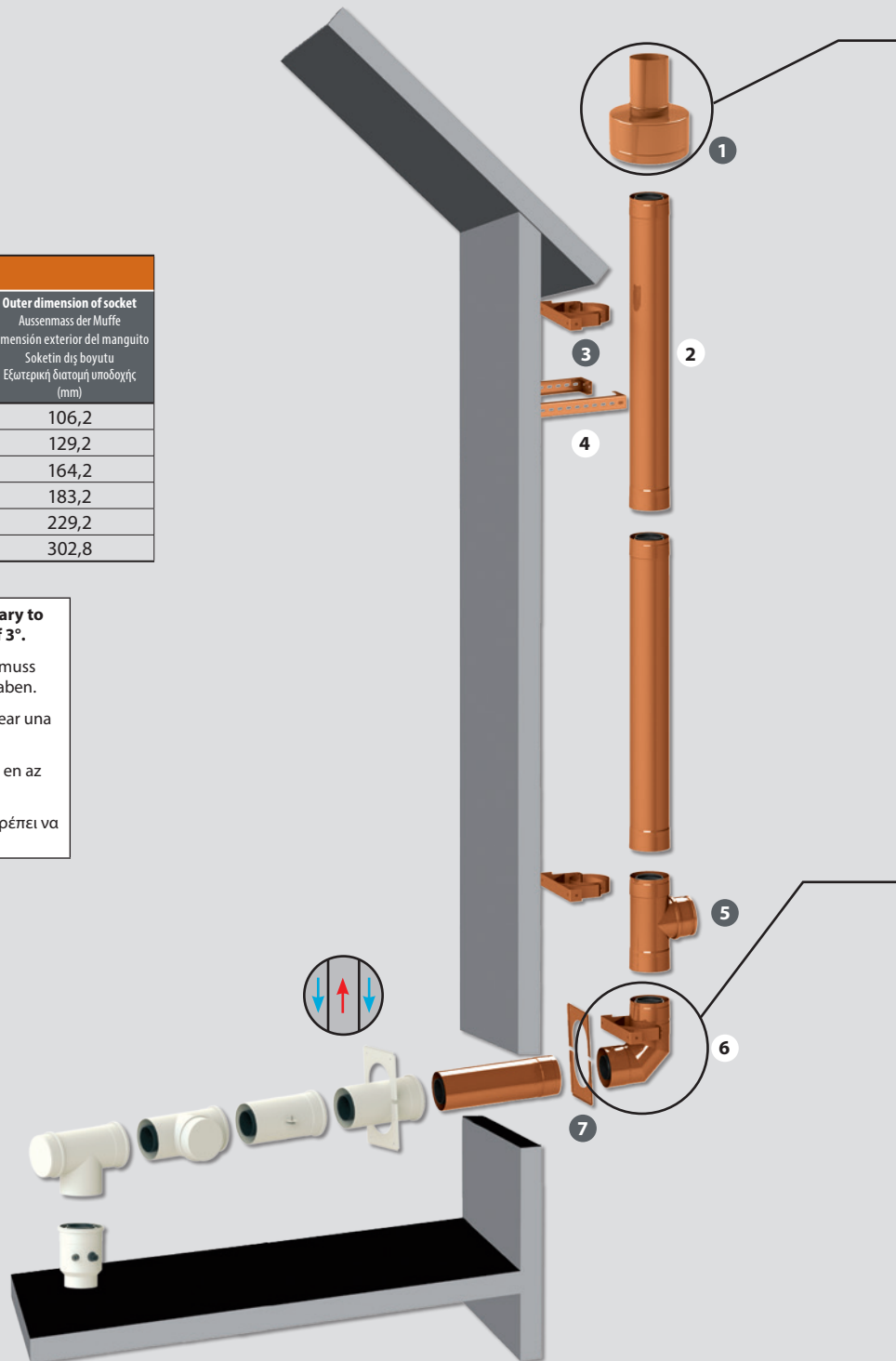

LAC

# EXTERNAL CONCENTRIC AIR-GAS FLUE SYSTEM

KONZENTRISCHES AUSSENWANDSYSTEM

SISTEMA DE EVACUACIÓN CONCÉNTRICO PARA EL EXTERIOR

HARİCİ KONSANTRİK HAVA-GAZ BACA SİSTEMİ

ΟΜΟΚΕΝΤΡΙΚΟ ΣΥΣΤΗΜΑ ΚΑΠΝΟΔΟΧΟΥ ΕΣΩΤΕΡΙΚΗΣ ΧΡΗΣΗΣ

**Ø60/100 – 110/160 mm**

**LAC**

PPH/stainless steel – copper coated

PPH/Edelstahl kupferbeschichtet

PPH/acero inoxidable cobreado

PPH/paslanmaz çelik - bakır kaplı

PPH/ανοξειδωτος χάλυβας – χαλκός

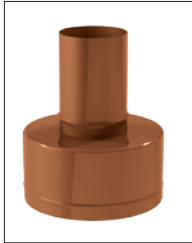

**Insert LAC opening with suction into the last pipe with socket.**

LAC Mündungsrohr in letzte PPH-Muffe einstecken.

Insertar el tubo del LAC Terminal con entrada de aire en el manguito del último tubo PPH.

LAC açığıni yerleştirin içine emme ile soketli son boru.

Εισάγετε το άνοιγμα LAC με αναρρόφηση στον τελευταίο σωλήνα με υποδοχή.

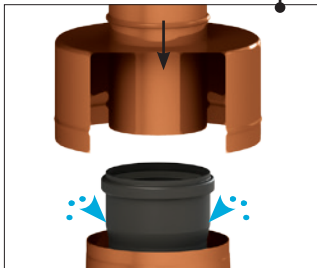

**LAC tee with inspection door with air supply enables suction of combustion air.**

Verbrennungsluft wird durch LAC Revisions-T mit Zuluft angesaugt.

La LAC Te-inspección con entrada de aire permite la aspiración del aire de combustión.

Denetimli LAC tee hava beslemeli kapı etkinleştirir yanma havasının emilmesi.

Ταφ με θυρίδα επιθεώρησης LAC και παροχή αέρα που επιτρέπει την αναρρόφηση του αέρα καύσης.

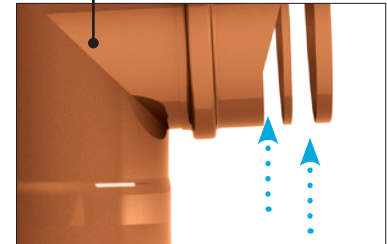
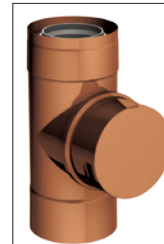

**Combination of LAC elbow 87° with wall bracket (reinforced) and LAC pipe.**

Kombination aus LAC Stützbogen mit Wandkonsole (verstärkt) und LAC Rohr.

Combinación de LAC codo de apoyo 87° con soporte pared (reforzado) y LAC Tubo.

LAC dirseğinin 87° ile kombinasyonu duvar braketi (güçlendirilmiş) ve LAC boru.

Συνδυασμός καμπύλης 87° με στήριγμα τοίχου LAC (ενισχυμένο).

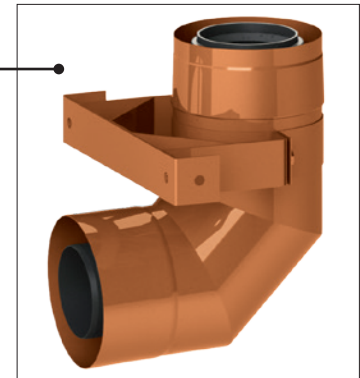
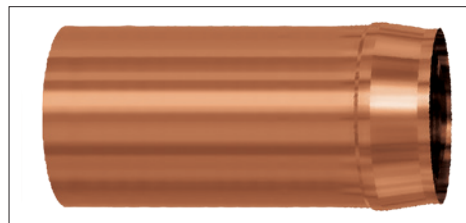

LAC

**Assembly instruction of adaptor LIB/LIL to LAC.**

Montageanleitung des Adapters LIB/LIL auf LAC.

Instrucciones de montaje del adaptador LIB/LIL a LAC.

LIB/LIL - LAC adaptörünün montaj talimatı.

Μέθοδος εγκατάστασης του προσ/γέα LIB/LIL σε LAC.



**LAC Socket**  
LAC Muffe  
LAC Manguito  
LAC Soket  
LAC υποδοχή

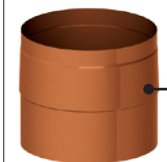

**Adapter LIB/LIL on LAC**  
Adapter LIB/LIL auf LAC  
Adaptador LIB/LIL a LAC.  
LAC üzerinde LIB/LIL Adaptörü.  
Προσ/γέας LIB/LIL σε LAC



**LIB/LIL Socket**  
LIB/LIL Muffe  
LIB/LIL Manguito  
LIB/LIL Soket  
LIB/LIL υποδοχή

**Assembly instruction of adaptor LAC to LIB/LIL.**

Montageanleitung des Adapters LAC auf LIB/LIL.

Instrucciones de montaje del adaptador LAC a LIB/LIL.

LAC adaptörünün LIB/LIL'e montaj talimatı.

Μέθοδος εγκατάστασης του προσ/γέα LAC σε LIB/LIL.



**LIB/LIL Pipe**  
LIB/LIL Rohr  
LIB/LIL Tubo  
LIB/LIL Boru  
LIB/LIL σωλήνα

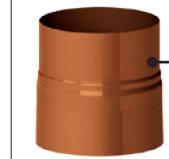

**Adapter LAC on LIB/LIL**  
Adapter LAC auf LIB/LIL  
Adaptador LAC a LIB/LIL  
LIB/LIL üzerinde LAC Adaptörü.  
Προσ/γέας LAC σε LIB/LIL



**LAC-Sicke**  
LAC-Sicke  
LAC-Ondulación  
LAC-Sicke  
LAC αρσενική υποδοχή

# EXTERNAL CONCENTRIC AIR-GAS FLUE SYSTEM

# LAM/LAC

KONZENTRISCHES AUSSENWANDSYSTEM

LAM – PPH/stainless steel – matt

SISTEMA DE EVACUACIÓN CONCÉNTRICO PARA EL EXTERIOR

PPH/Edelstahl matt · PPH/acero inoxidable mate

HARÍCI KONSANTRIK HAVA-GAZ BACA SİSTEMİ

PPH/paslanmaz çelik - mat · PPH/ανοξειδωτος χάλυβας - ματ

ΟΜΟΚΕΝΤΡΙΚΟ ΣΥΣΤΗΜΑ ΚΑΠΝΟΔΟΧΟΥ ΕΣΩΤΕΡΙΚΗΣ ΧΡΗΣΗΣ

LAC – PPH/stainless steel – copper coated

PPH/Edelstahl kupferbeschichtet · PPH/acero inoxidable cobreado  
PPH/paslanmaz çelik - bakır kaplı · PPH/ανοξειδωτος χάλυβας - χαλκός

## LAM Ø60/100 – 200/300 mm, LAC Ø60/100 – 110/160 mm

**LAM/LAC Pipe with socket**  
LAM/LAC Rohr m. Muffe · LAM/LAC Tubo M/H · LAM/LAC Soketli boru · LAM/LAC Σωλήνα με υποδοχή (κεφάλι)

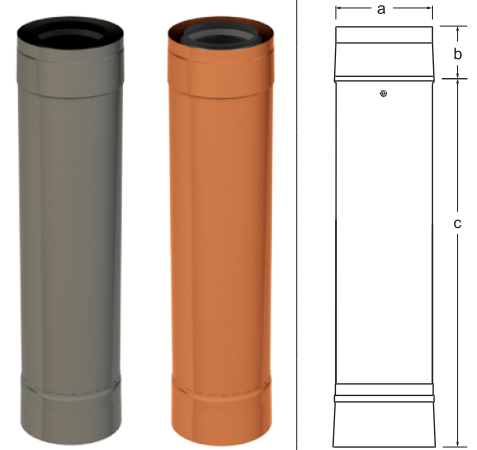

Ø	Code Código Kod Κωδ.		a (mm)	b (mm)	c (mm)	d (mm)
	LAM	LAC				
250 mm	60/100	APRM05 APRC05	100	62	188	-
	80/125	APRM08 APRC08	125	62	188	-
	100/150	APRM0X APRC0X	150	62	188	-
	110/160	APRM01 APRC01	160	62	188	-
	125/180	APRM02 APRC02	180	62	188	-
	160/225	APRM06 APRC06	225	62	188	-
	200/300	APRM00 APRC00	300	62	188	-
500 mm	60/100	APRM55 APRC55	100	62	438	-
	80/125	APRM58 APRC58	125	62	438	-
	100/150	APRM5X APRC5X	150	62	438	-
	110/160	APRM51 APRC51	160	62	438	-
	125/180	APRM52 APRC52	180	62	438	-
	160/225	APRM56 APRC56	225	62	438	-
	200/300	APRM50 APRC50	300	62	438	-
1000 mm	60/100	APRM15 APRC15	100	62	938	-
	80/125	APRM18 APRC18	125	62	938	-
	100/150	APRM1X APRC1X	150	62	938	-
	110/160	APRM11 APRC11	160	62	938	-
	125/180	APRM12 APRC12	180	62	938	-
	160/225	APRM16 APRC16	225	62	938	-
	200/300	APRM00 APRC10	300	62	938	-

**LAM/LAC Adjustable pipe with clamp**  
LAM/LAC Schieberohr · LAM/LAC Tubo extensible · LAM/LAC Keleççeli ayarlanabilir boru · LAM/LAC Πτυσσόμενος σωλήνας με σφιγκτήρα

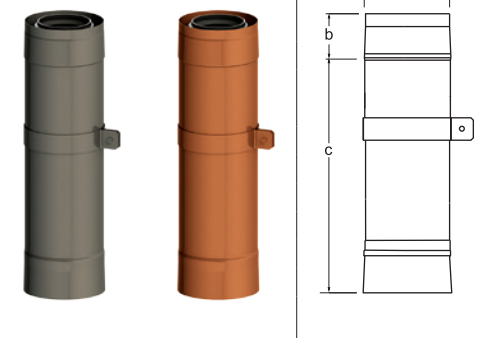

Ø	Code Código Kod Κωδ.		a (mm)	b (mm)	c (mm)	d (mm)
	LAM	LAC				
200 - 320 mm	60/100	APSM25 APSC25	100	62	188	-
	80/125	APSM28 APSC28	125	62	188	-
	100/150	APSM2X APSC2X	150	62	188	-
	110/160	APSM21 APSC21	160	62	188	-
	125/180	APSM22 APSC22	180	62	188	-
	160/225	APSM26 APSC26	225	62	188	-
	200/300	APSM20 APSC20	300	62	188	-
290 - 500 mm	60/100	APSM55 APSC55	100	62	438	-
	80/125	APSM58 APSC58	125	62	438	-
	100/150	APSM5X APSC5X	150	62	438	-
	110/160	APSM51 APSC51	160	62	438	-
	125/180	APSM52 APSC52	180	62	438	-
	160/225	APSM56 APSC56	225	62	438	-
	200/300	APSM50 APSC50	300	62	438	-

**LAM/LAC transition pipe**  
LAM/LAC Rohr zu Stützbogen · LAM/LAC Tubo pr. codo apoyo · LAM/LAC geçiş borusu · LAM/LAC Σωλήνας μετάβασης

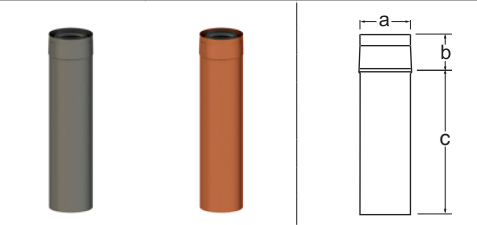

Ø	Code Código Kod Κωδ.		a (mm)	b (mm)	c (mm)	d (mm)
	LAM	LAC				
500 mm	60/100	APRSM5 APRSC5	100	62	448	-
	80/125	APRSM8 APRSC8	125	62	448	-
	100/150	APRSMX APRSCX	150	62	448	-
	110/160	APRSM1 APRSC1	160	62	448	-
	125/180	APRSM2 APRSC2	180	62	448	-
	160/225	APRSM6 APRSC6	225	62	448	-
	200/300	APRSM0 APRSC0	300	62	448	-

# EXTERNAL CONCENTRIC AIR-GAS FLUE SYSTEM

**LAM/LAC**

KONZENTRISCHES AUSSENWANDSYSTEM

LAM – PPH/stainless steel – matt

SISTEMA DE EVACUACIÓN CONCÉNTRICO PARA EL EXTERIOR

PPH/Edelstahl matt · PPH/acero inoxidable mate

HARÍCI KONSANTRIK HAVA-GAZ BACA SİSTEMİ

PPH/paslanmaz çelik - mat · PPH/ανοξειδωτος χάλυβας – ματ

ΟΜΟΚΕΝΤΡΙΚΟ ΣΥΣΤΗΜΑ ΚΑΠΝΟΔΟΧΟΥ ΕΣΩΤΕΡΙΚΗΣ ΧΡΗΣΗΣ

LAC – PPH/stainless steel – copper coated

PPH/Edelstahl kupferbeschichtet · PPH/acero inoxidable cobreado

PPH/paslanmaz çelik - bakır kaplı · PPH/ανοξειδωτος χάλυβας – χαλκός

**LAM Ø60/100 – 200/300 mm, LAC Ø60/100 – 110/160 mm**

**LAM/LAC Inspection-Tee**  
LAM/LAC Revisions-T · LAM/LAC Te-Inspección · LAM/LAC Muayene T'si · LAM/LAC Ταφ με θυρίδα επιθεώρησης

Ø	Code Código Kod Κωδ.		a (mm)	b (mm)	c (mm)	d (mm)
	LAM	LAC				
60/100	APRTM5	APRTC5	100	62	90	150
80/125	APRTM8	APRTC8	125	62	90	150
100/150	APRTMX	APRTCX	150	62	100	170
110/160	APRTM1	APRTC1	160	62	100	170
125/180	APRTM2	APRTC2	180	62	120	190
160/225	APRTM6	APRTC6	225	62	150	220
200/300	APRTM0	APRTC0	300	62	150	220

**LAM/LAC Inspection-Tee with air intake**  
LAM/LAC Revisions-T m. Zuluft · LAM/LAC Te-Inspecc. con entrada de aire · Hava girişli LAM/LAC Muayene T'si · LAM/LAC Ταφ με θυρίδα επιθεώρησης και παροχή αέρα καύσης

Ø	Code Código Kod Κωδ.		a (mm)	b (mm)	c (mm)	d (mm)
	LAM	LAC				
60/100	APRZM5	APRZC5	100	62	90	150
80/125	APRZM8	APRZC8	125	62	90	150
100/150	APRZMX	APRZCX	150	62	100	170
110/160	APRZM1	APRZC1	160	62	100	170
125/180	APRZM2	APRZC2	180	62	120	190
160/225	APRZM6	APRZC6	225	62	150	220
200/300	APRZM0	APRZC0	300	62	150	220

**LAM/LAC Tee-Piece with air intake w/o inspection**  
LAM/LAC T-Stk. mit Zuluft ohne Revision · LAM/LAC Te con entrada de aire (sin inspec.) · Denetimsiz hava girişli LAM/LAC Tee-Parçası · LAM/LAC Ταφ χωρίς θυρίδα επιθεώρησης με παροχή αέρα καύσης

Ø	Code Código Kod Κωδ.		a (mm)	b (mm)	c (mm)	d (mm)
	LAM	LAC				
60/100	APTZM5	APTZC5	100	62	90	150
80/125	APTZM8	APTZC8	125	62	90	150
100/150	APTZMX	APTZCX	150	62	100	170
110/160	APTZM1	APTZC1	160	62	100	170
125/180	APTZM2	APTZC2	180	62	120	190
160/225	APTZM6	APTZC6	225	62	150	220
200/300	APTZM0	APTZC0	300	62	150	220

**LAM/LAC Elbow 15°**  
LAM/LAC Bogen 15° · LAM/LAC Codo 15° · LAM/LAC Dirsek 15° · LAM/LAC Καμπύλη 15°

Ø	Code Código Kod Κωδ.		a (mm)	b (mm)	c (mm)	d (mm)
	LAM	LAC				
60/100	APBM15	APBC15	100	62	100	100
80/125	APBM18	APBC18	125	62	105	100
100/150	APBM1X	APBC1X	150	62	110	107
110/160	APBM11	APBC11	160	62	110	107
125/180	APBM12	APBC12	180	62	130	130
160/225	APBM16	APBC16	225	62	130	130
200/300	APBM10	APBC10	300	62	130	130

LAM

LAC

# EXTERNAL CONCENTRIC AIR-GAS FLUE SYSTEM

# LAM/LAC

KONZENTRISCHES AUSSENWANDSYSTEM

LAM – PPH/stainless steel – matt

SISTEMA DE EVACUACIÓN CONCÉNTRICO PARA EL EXTERIOR

PPH/Edelstahl matt · PPH/acero inoxidable mate

HARÍCI KONSANTRIK HAVA-GAZ BACA SİSTEMİ

PPH/paslanmaz çelik - mat · PPH/ανοξειδωτος χάλυβας – ματ

ΟΜΟΚΕΝΤΡΙΚΟ ΣΥΣΤΗΜΑ ΚΑΠΝΟΔΟΧΟΥ ΕΣΩΤΕΡΙΚΗΣ ΧΡΗΣΗΣ

LAC – PPH/stainless steel – copper coated



PPH/Edelstahl kupferbeschichtet · PPH/acero inoxidable cobreado

PPH/paslanmaz çelik - bakır kaplı · PPH/ανοξειδωτος χάλυβας – χαλκός

## LAM Ø60/100 – 200/300 mm, LAC Ø60/100 – 110/160 mm



### LAM/LAC Elbow 30°

LAM/LAC Bogen 30° · LAM/LAC Codo 30° · LAM/LAC Dirsek 30° · LAM/LAC Καμπύλη 30°

	Ø	Code Código Kod Κωδ.		a (mm)	b (mm)	c (mm)	d (mm)
		LAM	LAC				
	60/100	APBM35	APBC35	100	62	105	105
	80/125	APBM38	APBC38	125	62	120	120
	100/150	APBM3X	APBC3X	150	62	130	130
	110/160	APBM31	APBC31	160	62	130	130
	125/180	APBM32	APBC32	180	62	160	155
	160/225	APBM36	APBC36	225	62	160	155
	200/300	APBM30	APBC30	300	62	160	155



### LAM/LAC Elbow 45°

LAM/LAC Bogen 45° · LAM/LAC Codo 45° · LAM/LAC Dirsek 45° · LAM/LAC Καμπύλη 45°

	Ø	Code Código Kod Κωδ.		a (mm)	b (mm)	c (mm)	d (mm)
		LAM	LAC				
	60/100	APBM45	APBC45	100	62	135	140
	80/125	APBM48	APBC48	125	62	135	140
	100/150	APBM4X	APBC4X	150	62	150	155
	110/160	APBM41	APBC41	160	62	150	155
	125/180	APBM42	APBC42	180	62	170	160
	160/225	APBM46	APBC46	225	62	195	190
	200/300	APBM40	APBC40	300	62	195	192

### LAM/LAC Elbow 87°

LAM/LAC Bogen 87° · LAM/LAC Codo 87° · LAM/LAC Dirsek 87° · LAM/LAC Καμπύλη 87°

	Ø	Code Código Kod Κωδ.		a (mm)	b (mm)	c (mm)	d (mm)
		LAM	LAC				
	60/100	APBM95	APBC95	100	62	200	130
	80/125	APBM98	APBC98	125	62	235	150
	100/150	APBM9X	APBC9X	150	62	250	155
	110/160	APBM91	APBC91	160	62	250	155
	125/180	APBM92	APBC92	180	62	260	175
	160/225	APBM96	APBC96	225	62	270	220
	200/300	APBM90	APBC90	300	62	270	220

### LAM/LAC Base support bracket complete

LAM/LAC Wandkonsole komplett · LAM/LAC Base mural completa · LAM/LAC Taban destek braketi tamamlandı · LAM/LAC Καμπύλη στερέωσης 87° με βραχίονα στήριξης

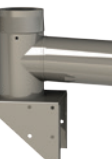
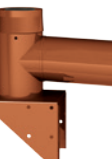
	Ø	Code Código Kod Κωδ.		a (mm)	b (mm)	c (mm)	d (mm)
		LAM	LAC				
	60/100	APWKM5	APWKC5	100	125	260	155
	80/125	APWKM8	APWKC8	125	175	290	220
	100/150	APWKMx	APWKCx	150	150	360	220
	110/160	APWKM1	APWKC1	160	150	360	220
	125/180	APWKM2	APWKC2	180	160	390	225
	160/225	APWKM6	APWKC6	-	-	-	-
	200/300	APWKM0	APWKC0	-	-	-	-

LAM

LAC

# EXTERNAL CONCENTRIC AIR-GAS FLUE SYSTEM

# LAM/LAC

KONZENTRISCHES AUSSENWANDSYSTEM

LAM – PPH/stainless steel – matt

SISTEMA DE EVACUACIÓN CONCÉNTRICO PARA EL EXTERIOR

PPH/Edelstahl matt · PPH/acero inoxidable mate

HARÍCI KONSANTRIK HAVA-GAZ BACA SİSTEMİ

PPH/paslanmaz çelik - mat · PPH/ανοξειδωτος χάλυβας – ματ

ΟΜΟΚΕΝΤΡΙΚΟ ΣΥΣΤΗΜΑ ΚΑΠΝΟΔΟΧΟΥ ΕΣΩΤΕΡΙΚΗΣ ΧΡΗΣΗΣ

LAC – PPH/stainless steel – copper coated

PPH/Edelstahl kupferbeschichtet · PPH/acero inoxidable cobreado

PPH/paslanmaz çelik - bakır kaplı · PPH/ανοξειδωτος χάλυβας – χαλκός

## LAM Ø60/100 – 200/300 mm, LAC Ø60/100 – 110/160 mm

**LAM/LAC Support Elbow 87° with pipe**  
LAM/LAC Stützbogen 87° m. Rohr · LAM/LAC Codo apoyo 87° con tubo · LAM/LAC Destek Dirseği 87° borulu · LAM/LAC Καμπύλη 87° με προέκταση

Ø	Code Código Kod Κωδ.		a (mm)	b (mm)	c (mm)	d (mm)
	LAM	LAC				
60/100	APSBM5	APSBC5	100	62	200	448
80/125	APSBM8	APSBC8	125	62	235	448
100/150	APSBMX	APSBCX	150	62	250	448
110/160	APSBM1	APSBC1	160	62	250	448
125/180	APSBM2	APSBC2	180	62	260	448
160/225	APSBM6	APSBC6	225	62	270	448
200/300	APSBM0	APSBC0	300	62	270	448

**LAM/LAC Roof terminal**  
LAM/LAC Dachaufsatz · LAM/LAC Terminal vertical · LAM/LAC Çatı terminali · LAM/LAC Προέκταση οροφής με προστατευτικό βροχής

Ø	Code Código Kod Κωδ.		a (mm)	b (mm)	c (mm)	d (mm)
	LAM	LAC				
60/100	APDM45	APDC45	310	690	930	115
80/125	APDM48	APDC48	310	690	930	135
100/150	APDM4X	APDC4X	310	690	930	180
110/160	APDM41	APDC41	310	690	930	180
125/180	APDM42	APDC42	310	690	930	200
160/225	APDM46	APDC46	310	690	930	245
200/300	APDM40	APDC40	310	690	930	320

**LAM/LAC Socket (F) for cutted pipes**  
LAM/LAC Muffe female z. Rohrkürzung · LAM/LAC Manguito (H) pr. tubos cortados · Kesilmiş borular için LAM/LAC Soket (F) · LAM/LAC Υποδοχή για κοπή σωλήνα

Ø	Code Código Kod Κωδ.		a (mm)	b (mm)	c (mm)	d (mm)
	LAM	LAC				
60/100	APMKM5	APMKC5	40	80	-	-
80/125	APMKM8	APMKC8	72	118	-	-
100/150	APMKMX	APMKCX	70	120	-	-
110/160	APMKM1	APMKC1	70	120	-	-
125/180	APMKM2	APMKC2	70	120	-	-
160/225	APMKM6	APMKC6	70	120	-	-
200/300	APMKM0	APMKC0	70	120	-	-

**LAM/LAC Top terminal with air intake**  
LAM/LAC Mündungsabschluss m. Zuluft · LAM/LAC Terminal con entrada de aire · LAM/LAC Hava girišli üst terminal · LAM/LAC Άνοιγμα με αναρρόφηση

Ø	Code Código Kod Κωδ.		a (mm)	b (mm)	c (mm)	d (mm)
	LAM	LAC				
60/100	-	APMSC5	160	175	155	340
80/125	APMSM8	APMSC8	160	120	180	280
100/150	APMSMX	APMSCX	160	120	180	280
110/160	APMSM1	APMSC1	160	120	180	280
125/180	APMSM2	APMSC2	170	115	235	280
160/225	APMSM6	APMSC6	145	125	290	295
200/300	APMSM0	APMSC0	145	120	390	265

LAM

LAC

# EXTERNAL CONCENTRIC AIR-GAS FLUE SYSTEM

**LAM/LAC**

KONZENTRISCHES AUSSENWANDSYSTEM

LAM – PPH/stainless steel – matt

SISTEMA DE EVACUACIÓN CONCÉNTRICO PARA EL EXTERIOR

PPH/Edelstahl matt · PPH/acero inoxidable mate

HARÍCI KONSANTRIK HAVA-GAZ BACA SİSTEMİ

PPH/paslanmaz çelik - mat · PPH/ανοξειδωτος χάλυβας – ματ

ΟΜΟΚΕΝΤΡΙΚΟ ΣΥΣΤΗΜΑ ΚΑΠΝΟΔΟΧΟΥ ΕΣΩΤΕΡΙΚΗΣ ΧΡΗΣΗΣ

LAC – PPH/stainless steel – copper coated

PPH/Edelstahl kupferbeschichtet · PPH/acero inoxidable cobreado

PPH/paslanmaz çelik - bakır kaplı · PPH/ανοξειδωτος χάλυβας – χαλκός

**LAM Ø60/100 – 200/300 mm, LAC Ø60/100 – 110/160 mm**



## LAM/LAC Clamp for connection reinforcement

LAM/LAC Sturmschelle · LAM/LAC Abrazadera refuerzo conexiones · Bağlantı takviyesi için LAM/LAC Keleçe · LAM/LAC Σφικτήρας για ενίσχυση σύνδεσης

	Ø	Code Código Kod Κωδ.		a (mm)	b (mm)	c (mm)	d (mm)
		LAM	LAC				
	60/100	APKLM5	APKLC5	105	105	-	-
	80/125	APKLM8	APKLC8	105	130	-	-
	100/150	APKLMX	APKLCX	105	155	-	-
	110/160	APKLM1	APKLC1	105	165	-	-
	125/180	APKLM2	APKLC2	105	185	-	-
	160/225	APKLM6	APKLC6	105	230	-	-
	200/300	APKLM0	APKLC0	105	305	-	-

## ZUB Universal roof flashing 5° - 55° UNI (complete)

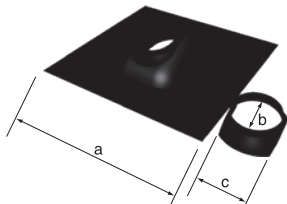
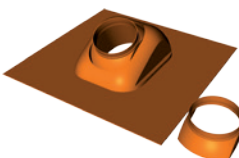
ZUB Universal-Dachpfanne 5° - 55° UNI (komplett) · ZUB Salida techo universal 5° - 55° completa · ZUB Üiversal çatı flaşörü 5° - 55° UNI (komple) · ZUB Διάβαση στέγης καπνοδόχου 5° - 55° UNI (πλήρες)

	Ø	Code Código Kod Κωδ.		a (mm)	b (mm)	c (mm)	i
		LAM	LAC				
	5° - 25°	60/100 - 80/125	ZUD02S	500	138	132	Plastic - black Kunststoff - schwarz Plástico negro Plastik - siyah Πλαστικό - μαύρο
		110/160	ZUD06S	700	165	180	
		60/100 - 80/125	ZUD02T	500	138	132	Plastic - terracotta Kunststoff - terracotta Plástico terracotta Plastik - terracotta Πλαστικό - τερακότα
		110/160	ZUD06T	700	165	180	
	25° - 45°	60/100 - 80/125	ZUD22S	500	138	132	Plastic - black Kunststoff - schwarz Plástico negro Plastik - siyah Πλαστικό - μαύρο
		110/160	ZUD26S	700	165	180	
		60/100 - 80/125	ZUD22T	500	138	132	Plastic - terracotta Kunststoff - terracotta Plástico terracotta Plastik - terracotta Πλαστικό - τερακότα
		110/160	ZUD26T	700	165	180	
	35° - 55°	60/100 - 80/125	ZUD32S	500	138	132	Plastic - black Kunststoff - schwarz Plástico negro Plastik - siyah Πλαστικό - μαύρο
		110/160	ZUD36S	700	165	180	
		60/100 - 80/125	ZUD32T	500	138	132	Plastic - terracotta Kunststoff - terracotta Plástico terracotta Plastik - terracotta Πλαστικό - τερακότα
		110/160	ZUD36T	700	165	180	

## ZUB Roof flashing

ZUB Dachpfanne · ZUB Salida techo · ZUB Çatı flashingleri · ZUB Διάβαση στέγης καπνοδόχου

	Ø	Code Código Kod Κωδ.		a (mm)	b (mm)	i
		LAM	LAC			
	60/100 - 80/125	ALPP35		-	-	Plastic - black Kunststoff - schwarz · Plástico negro · Plastik - siyah · Πλαστικό - μαύρο χρώμα
	-	-	-	-	-	
	-	-	-	-	-	

# EXTERNAL CONCENTRIC AIR-GAS FLUE SYSTEM

# LAM/LAC

KONZENTRISCHES AUSSENWANDSYSTEM

LAM – PPH/stainless steel – matt

SISTEMA DE EVACUACIÓN CONCÉNTRICO PARA EL EXTERIOR

PPH/Edelstahl matt · PPH/acero inoxidable mate

HARÍCI KONSANTRIK HAVA-GAZ BACA SİSTEMİ

PPH/paslanmaz çelik - mat · PPH/ανοξειδωτος χάλυβας – ματ

ΟΜΟΚΕΝΤΡΙΚΟ ΣΥΣΤΗΜΑ ΚΑΠΝΟΔΟΧΟΥ ΕΣΩΤΕΡΙΚΗΣ ΧΡΗΣΗΣ

LAC – PPH/stainless steel – copper coated

PPH/Edelstahl kupferbeschichtet · PPH/acero inoxidable cobreado

PPH/paslanmaz çelik - bakır kaplı · PPH/ανοξειδωτος χάλυβας – χαλκός

## LAM Ø60/100 – 200/300 mm, LAC Ø60/100 – 110/160 mm

**LAM/LAC Wall bracket extension I**  
LAM/LAC Wandkonsolenverlängerung I • LAM/LAC Extensión base mural I • LAM/LAC Duvar braketi uzatması I • LAM/LAC Προέκταση βραχίονα στήριξης I

Ø	Code Código Kod Κωδ.		a (mm)	b (mm)	c (mm)	d (mm)
	LAM	LAC				
60/100	APW1M5	APW1C5	190	165	0-160	50-210
80/125	APW1M8	APW1C8	190	180	0-100	50-150
100/150	APW1MX	APW1CX	190	210	0-155	50-205
110/160	APW1M1	APW1C1	190	210	0-155	50-205
125/180	APW1M2	APW1C2	250	235	0-220	50-270
160/225	APW1M6	APW1C6	-	-	-	-
200/300	APW1M0	APW1C0	-	-	-	-

**LAM/LAC Wall bracket extension II**  
LAM/LAC Wandkonsolenverlängerung II • LAM/LAC Extensión base mural II • LAM/LAC Duvar braketi uzatması II • LAM/LAC Προέκταση βραχίονα στήριξης II

Ø	Code Código Kod Κωδ.		a (mm)	b (mm)	c (mm)	d (mm)
	LAM	LAC				
60/100	APW2M5	APW2C5	90	165	100-245	150-295
80/125	APW2M8	APW2C8	90	180	100-185	150-235
100/150	APW2MX	APW2CX	120	210	120-185	170-235
110/160	APW2M1	APW2C1	120	210	120-185	170-235
125/180	APW2M2	APW2C2	-	-	-	-
160/225	APW2M6	APW2C6	-	-	-	-
200/300	APW2M0	APW2C0	-	-	-	-

**LAM/LAC Wall bracket extension III**  
LAM/LAC Wandkonsolenverlängerung III • LAM/LAC Extensión base mural III • LAM/LAC Duvar braketi uzatması III • LAM/LAC Προέκταση βραχίονα στήριξης III

Ø	Code Código Kod Κωδ.		a (mm)	b (mm)	c (mm)	d (mm)
	LAM	LAC				
60/100	APW2M5	APW3C5	165	165	180-280	230-330
80/125	APW2M8	APW3C8	170	170	180-280	230-330
100/150	APW2MX	APW3CX	180	165	180-280	230-330
110/160	APW2M1	APW3C1	180	165	180-280	230-330
125/180	APW2M2	APW3C2	225	210	175-340	225-390
160/225	APW2M6	APW3C6	-	-	-	-
200/300	APW2M0	APW3C0	-	-	-	-

**LAM/LAC Wall bracket (reinforced)**  
LAM/LAC Wandhalterung (verstärkt) • LAM/LAC Soporte mural reforzado • LAM/LAC Duvar braketi (güçlendirilmiş) • LAM/LAC Στήριγμα τοίχου (ενισχυμένο)

Ø	Code Código Kod Κωδ.		a (mm)	b (mm)	c (mm)	d (mm)
	LAM	LAC				
60/100	APWHM5	APWHC5	100	150	230	45
80/125	APWHM8	APWHC8	125	175	225	45
100/150	APWHMX	APWHCX	150	205	285	50
110/160	APWHM1	APWHC1	160	215	295	50
125/180	APWHM2	APWHC2	180	230	245	50
160/225	APWHM6	APWHC6	225	270	285	50
200/300	APWHM0	APWHC0	300	350	360	50

LAM

LAC

# EXTERNAL CONCENTRIC AIR-GAS FLUE SYSTEM

# LAM/LAC

KONZENTRISCHES AUSSENWANDSYSTEM

SISTEMA DE EVACUACIÓN CONCÉNTRICO PARA EL EXTERIOR

HARÍCI KONSANTRIK HAVA-GAZ BACA SİSTEMİ

ΟΜΟΚΕΝΤΡΙΚΟ ΣΥΣΤΗΜΑ ΚΑΠΝΟΔΟΧΟΥ ΕΣΩΤΕΡΙΚΗΣ ΧΡΗΣΗΣ

LAM – PPH/stainless steel – matt

PPH/Edelstahl matt · PPH/acero inoxidable mate

PPH/paslanmaz çelik - mat · PPH/ανοξειδωτος χάλυβας – ματ

LAC – PPH/stainless steel – copper coated

PPH/Edelstahl kupferbeschichtet · PPH/acero inoxidable cobreado

PPH/paslanmaz çelik - bakır kaplı · PPH/ανοξειδωτος χάλυβας – χαλκός

## LAM Ø60/100 – 200/300 mm, LAC Ø60/100 – 110/160 mm

**LAM/LAC Wall bracket extension (reinforced)**  
LAM/LAC Verlängerung der Wandhalterung · LAM/LAC Extensión soporte mural · LAM/LAC Duvar braketi uzatması (güçlendirilmiş)  
• LAM/LAC Προέκταση στηρίγματος τοίχου (ενισχυμένο)

Ø	Code Código Kod Κωδ.		a (mm)	b (mm)	c (mm)	d (mm)
	LAM	LAC				
60/100	APVUMU	APVUCU	395	85	15	-
80/125						
100/150						
110/160						
125/180						
160/225						
200/300						

**LAM/LAC One-piece cover plate**  
LAM/LAC Abdeckblende · LAM/LAC Remate mural · LAM/LAC Tek parça kapak plakası · LAM/LAC Πλάκα κάλυψης ενός τμήματος

Ø	Code Código Kod Κωδ.		a (mm)	b (mm)	c (mm)	d (mm)
	LAM	LAC				
60/100	LPWM05	LPWC05	250	103	-	-
80/125	LPWM08	LPWC08	250	128	-	-
100/150	LPWM0X	LPWC0X	250	155	-	-
110/160	LPWM01	LPWC01	250	165	-	-
125/180	LPWM02	LPWC02	400	182	-	-
160/225	LPWM06	LPWC06	400	227	-	-
200/300	LPWM00	LPWC00	-	-	-	-

**LAM/LAC Two-piece cover plate**  
LAM/LAC Abdeckblende 2-teilig · LAM/LAC Remate mural seccionado · LAM/LAC İki parçalı kapak plakası · LAM/LAC Πλάκα κάλυψης δύο τμημάτων

Ø	Code Código Kod Κωδ.		a (mm)	b (mm)	c (mm)	d (mm)
	LAM	LAC				
60/100	LPW2M5	LPW2C5	160	115	85	-
80/125	LPW2M8	LPW2C8	180	145	120	-
100/150	LPW2MX	LPW2CX	230	155	130	-
110/160	LPW2M1	LPW2C1	230	165	130	-
125/180	LPW2M2	LPW2C2	-	-	-	-
160/225	LPW2M6	LPW2C6	-	-	-	-
200/300	LPW2M0	LPW2C0	-	-	-	-

**Adapter LIB/LIL on LAM/LAC**  
LAM/LAC Muffenwechsel m. kon. Muffe m/m · LAM/LAC Adaptador LIB/LIL a LAM/LAC · LAM/LAC üzerinde LIB/LIL Adaptörü  
• Προσ/γέας LIB/LIL σε LAM/LAC

Ø	Code Código Kod Κωδ.		a (mm)	b (mm)	c (mm)	d (mm)
	LAM	LAC				
60/100	APSKM5	APSKC5	60	100	-	-
80/125	APSKM8	APSKC8	80	126	-	-
100/150	APSKMX	APSKCX	80	126	-	-
110/160	APSKM1	APSKC1	80	126	-	-
125/180	APSKM2	APSKC2	80	126	-	-
160/225	APSKM6	APSKC6	80	126	-	-
200/300	APSKM0	APSKC0	80	126	-	-

**Adapter LAM/LAC on LIB/LIL**  
LAM/LAC Muffenwechsel Dachaufsatz · LAM/LAC Adaptador LAM/LAC a LIB/LIL · LAM/LAC üzerinde LIB/LIL Adaptörü  
• Προσ/γέας LAM/LAC σε LIB/LIL

Ø	Code Código Kod Κωδ.		a (mm)	b (mm)	c (mm)	d (mm)
	LAM	LAC				
60/100	APDMM5	APDMC5	60	100	-	-
80/125	APDMM8	APDMC8	80	126	-	-
100/150	APDMMX	APDMCX	80	126	-	-
110/160	APDMM1	APDMC1	80	126	-	-
125/180	APDMM2	APDMC2	80	126	-	-
160/225	APDMM6	APDMC6	80	126	-	-
200/300	APDMM0	APDMC0	80	126	-	-

# EXTERNAL CONCENTRIC AIR-GAS FLUE SYSTEM

**LAM/LAC**

KONZENTRISCHES AUSSENWANDSYSTEM

SISTEMA DE EVACUACIÓN CONCÉNTRICO PARA EL EXTERIOR

HARÍCI KONSANTRIK HAVA-GAZ BACA SİSTEMİ

ΟΜΟΚΕΝΤΡΙΚΟ ΣΥΣΤΗΜΑ ΚΑΠΝΟΔΟΧΟΥ ΕΣΩΤΕΡΙΚΗΣ ΧΡΗΣΗΣ

LAM – PPH/stainless steel – matt

PPH/Edelstahl matt · PPH/acero inoxidable mate

PPH/paslanmaz çelik - mat · PPH/ανοξειδωτος χάλυβας – ματ

LAC – PPH/stainless steel – copper coated

PPH/Edelstahl kupferbeschichtet · PPH/acero inoxidable cobreado

PPH/paslanmaz çelik - bakır kaplı · PPH/ανοξειδωτος χάλυβας – χαλκός

**LAM Ø60/100 – 200/300 mm, LAC Ø60/100 – 110/160 mm**

Instructions for anchoring chimney	Höhenmasse Aussenwandsystem	Medidas de altura del sistema para el exterior	Talimatlar için baca ankrajı	Οδηγίες στερέωσης καμινάδας
------------------------------------	-----------------------------	--	------------------------------	-----------------------------

**Above the last LAC wall bracket (reinforced) must be each connection clamped by a LAC clamp for connection reinforcement.**

Nach dem letzten Wandhalter jede Verbindung mit Rohrschelle sichern.

Después del último soporte de pared, asegurar cada conexión con una abrazadera refuerzo conexiones.

Son LAC duvar braketinin üstünde (güçlendirilmiş) her bir bağlantı, bağlantı için bir LAC kelepçesi ile kelepçelenmiştir takviye.

Πάνω από το τελευταίο στήριγμα τοίχου LAC (ενισχυμένο) πρέπει σε κάθε σύνδεση να τοποθετείται ένας σφιγκτήρας LAC για ενίσχυση σύνδεσης.

**Free length of the chimney above the last LAC wall bracket (reinforced) may be a maximum of 3 m.**

Freie Länge nach dem letzten Wandhalter bis zum Mündungsabschluss maximal 3m.

Longitud libre después del último soporte de pared hasta la salida del terminal máximo 3m.

Son LAC duvar braketinin üzerindeki bacanın serbest uzunluğu (güçlendirilmiş) en fazla 3 m olabilir.

Το ελεύθερο μήκος της καπνοδόχου πάνω από το τελευταίο στήριγμα τοίχου LAC (ενισχυμένο) μπορεί να είναι ένα μέγιστο 3 m.

**Structural height of the chimney where connections do not have to be clamped with LAC clamps for connection reinforcement.**

Aufbau bis letzten Wandhalter ohne Rohrschelle möglich

Altura estructural de la chimenea donde las conexiones no tienen que ser aseguradas con abrazaderas refuerzo conexiones.

Bağlantıların olduğu yerde bacanın yapısal yüksekliği LAC kelepçeleri ile kelepçelenmesi gerekmez bağlantı takviyesi için.

Δομικό ύψος της καμινάδας όπου οι συνδέσεις δεν χρειάζεται να στερεώνονται με σφιγκτήρες LAC για ενίσχυση σύνδεσης.

**Connection before the last LAC wall bracket (reinforced) must be clamped by a LAC clamp for connection reinforcement.**

Vor dem letzten Wandhalter ist eine Rohrschelle anzubringen.

Se debe colocar una abrazadera refuerzo conexiones delante del último soporte de pared.

Son LAC duvar braketinden önceki bağlantı (güçlendirilmiş) bağlantı için bir LAC kelepçesi ile kelepçelenmelidir takviye.

Πριν από το τελευταίο στήριγμα τοίχου LAC (ενισχυμένο) πρέπει να τοποθετηθεί ένας σφιγκτήρας LAC για ενίσχυση σύνδεσης.

**Distance between two LAC wall brackets (reinforced) may be a maximum of 4 m.**

Maximale Aufbauhöhe zwischen 2 Wandhaltern darf nicht mehr als 4m betragen.

La altura máxima de instalación entre 2 soportes de pared no debe superar los 4m.

İki LAC duvar braketi (güçlendirilmiş) arasındaki mesafe maksimum 4 m.

Η απόσταση μεταξύ δύο στηριγμάτων τοίχου LAC (ενισχυμένο) μπορεί να είναι το μέγιστο 4 m.

**First LAC wall bracket (reinforced) must be installed on LAC elbow 87°.**

Der 1. Wandhalter ist am Stützbogen zu montieren.

El primer soporte de pared debe montarse en el codo de apoyo.

İlk LAC duvar braketi (güçlendirilmiş) 87° LAC dirseğine takılmalıdır.

Το πρώτο στήριγμα τοίχου LAC (ενισχυμένο) πρέπει να εγκατασταθεί στην καμπύλη LAC 87°.

1	APMSC5
2	APWHC5
3	APRZC5
4	APSBC5
5	APKLC5
6	APRC15
7	LPWC05

**First LAC wall bracket (reinforced) must be installed on LAC elbow 87°.**

Der 1. Wandhalter ist am Stützbogen zu montieren.

El primer soporte de pared debe montarse en el codo de apoyo.

İlk LAC duvar braketi (güçlendirilmiş) 87° LAC dirseğine takılmalıdır.

Το πρώτο στήριγμα τοίχου LAC (ενισχυμένο) πρέπει να εγκατασταθεί στην καμπύλη LAC 87°.

LAM

LAC

# EXTERNAL CONCENTRIC AIR-GAS FLUE SYSTEM

**LAM/LAC**

KONZENTRISCHES AUSSENWANDSYSTEM

SISTEMA DE EVACUACIÓN CONCÉNTRICO PARA EL EXTERIOR

HARÍCI KONSANTRIK HAVA-GAZ BACA SİSTEMİ

ΟΜΟΚΕΝΤΡΙΚΟ ΣΥΣΤΗΜΑ ΚΑΠΝΟΔΟΧΟΥ ΕΣΩΤΕΡΙΚΗΣ ΧΡΗΣΗΣ

LAM – PPH/stainless steel – matt

PPH/Edelstahl matt · PPH/acero inoxidable mate

PPH/paslanmaz çelik - mat · PPH/ανοξειδωτος χάλυβας – ματ

LAC – PPH/stainless steel – copper coated

PPH/Edelstahl kupferbeschichtet · PPH/acero inoxidable cobreado

PPH/paslanmaz çelik - bakır kaplı · PPH/ανοξειδωτος χάλυβας – χαλκός

**LAM Ø60/100 – 200/300 mm, LAC Ø60/100 – 110/160 mm**

## Exchangeability of LAB tee with inspection door lids.

Aus LAB Revisions-T wird LAB Revisions-T mit Zuluft.

LAB Te-inspección se convierte en LAB Te-inspección con entrada de aire.

Değiştirilebilirlik ile LAC tişörtünün muayene kapısı kapakları.

Εναλλαξιμότητα καπακιών σε ταφ με θυρίδα επιθεώρησης LAB.

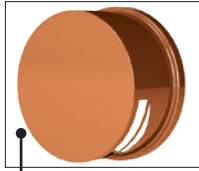

### LAC lid with air supply grille.

LAC Deckel mit Zuluftgitter.

LAC Tapa con rejilla entrada de aire.

LAC hava besleme izgaralı kapak.

LAC καπάκι με γρίλια για παροχή αέρα.



Air supply  
Zuluft  
Entrada de aire  
Hava beslemesi  
Αέρας καύσης

or  
oder  
o  
veya  
ή

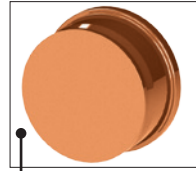

### LAC lid solid

LAC Deckel geschlossen

LAC Tapa cerrada

LAC kapak katı

LAC καπάκι χωρίς γρίλια για παροχή αέρα

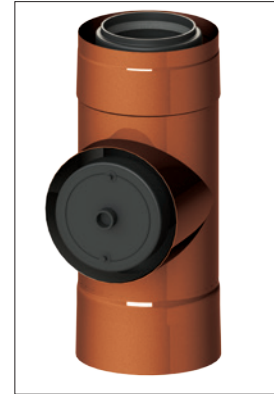

## Assembly of LAM/LAC extended wall bracket.

Montage LAM/LAC Wandkonsolenverlängerung.

Montaje de LAM/LAC extensión base mural.

LAM/LAC Montajı uzatılmış duvar braketi.

Τοποθέτηση Προέκταση βραχίονα στήριξης LAM/LAC.



### LAM/LAC wall bracket extension I, 50-150 mm (one part).

LAM/LAC Wandkonsolenverlängerung I, 50-150 mm (1 Bauteil).

LAM/LAC Extensión base mural I, 50-150 mm (1 componente).

LAM/LAC duvar braketi uzatma I, 50-150 mm (tek parça).

LAM/LAC Προέκταση βραχίονα στήριξης I, 50-150 mm (ένα τεμάχιο).

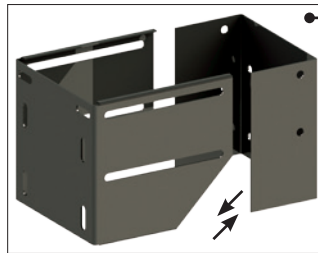

### LAM/LAC wall bracket extension II, 130-250 mm (two parts).

LAM/LAC Wandkonsolenverlängerung II, 130-250 mm (2 Bauteile).

LAM/LAC Extensión base mural II, 130-250 mm (2 componentes).

LAM/LAC duvar braketi uzatması II, 130-250 mm (iki parça).

LAM/LAC Προέκταση βραχίονα στήριξης II, 130-250 mm (δύο τεμάχια).

Connect and screw together at the desired distance.

Auf benötigte Distanz ineinander schieben und verschrauben.

Conectar y atornillar a la distancia deseada.

Bağlayın ve vidalayın birlikte istenen mesafe.

Συνδέστε και βιδώστε μαζί στην επιθυμητή απόσταση.

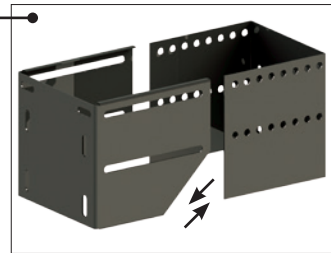

### LAM/LAC wall bracket extension III, 220-330 mm (two parts).

LAM/LAC Wandkonsolenverlängerung III, 220-330 mm (2 Bauteile).

LAM/LAC Extensión base mural III, 220-330 mm (2 componentes).

LAM/LAC duvar braketi uzatması III, 220-330 mm (iki parça).

LAM/LAC Προέκταση βραχίονα στήριξης III, 220-330 mm (δύο τεμάχια).

## Assembly of LAM/LAC wall bracket with wall bracket extension.

Montage des LAM/LAC Wandhalters mit der Wandhalterverlängerung.

Montaje del LAM/LAC soporte mural con la extensión del soporte.

LAM/LAC Montajı duvar ile duvar braketi dirsek uzantısı.

Τοποθέτηση προέκτασης στήριγματος τοίχου στήριξης LAM/LAC.

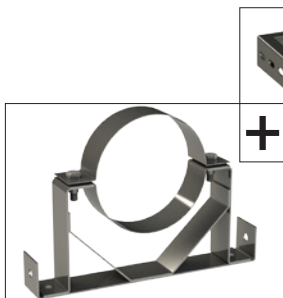

Connect and screw together at the desired distance.

Auf benötigte Distanz ineinander schieben und verschrauben.

Conectar y atornillar a la distancia deseada.

Bağlayın ve birbirine vidalayın istenen mesafede.

Συνδέστε και βιδώστε μαζί στην επιθυμητή απόσταση.

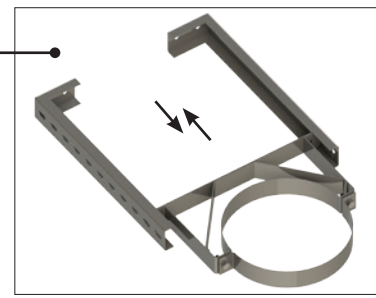

# EXTERNAL CONCENTRIC AIR-GAS FLUE SYSTEM

**LAM/LAC**

KONZENTRISCHES AUSSENWANDSYSTEM

**LAM – PPH/stainless steel – matt**

SISTEMA DE EVACUACIÓN CONCÉNTRICO PARA EL EXTERIOR

**PPH/Edelstahl matt · PPH/acero inoxidable mate**

HARİCİ KONSANTRİK HAVA-GAZ BACA SİSTEMİ

**PPH/paslanmaz çelik - mat · PPH/ανοξειδωτος χάλυβας – ματ**

ΟΜΟΚΕΝΤΡΙΚΟ ΣΥΣΤΗΜΑ ΚΑΠΝΟΔΟΧΟΥ ΕΞΩΤΕΡΙΚΗΣ ΧΡΗΣΗΣ

**LAC – PPH/stainless steel – copper coated**

**PPH/Edelstahl kupferbeschichtet · PPH/acero inoxidable cobreado**

**PPH/paslanmaz çelik - bakır kaplı · PPH/ανοξειδωτος χάλυβας – χαλκός**

**LAM Ø60/100 – 200/300 mm, LAC Ø60/100 – 110/160 mm**

Recommended length of deflections Empfohlene Länge der Abwinklungen • Longitud recomendada de las desviaciones • Önerilen sarma uzunluğu • Συνιστώμενο μήκος εκτροπών		Elbow 15° Bogen 15° · Codo 15° Dirsek 15° · Καμπύλη 15°			Elbow 30° Bogen 30° · Codo 30° Dirsek 30° · Καμπύλη 30°			Elbow 45° Bogen 45° · Codo 45° Dirsek 45° · Καμπύλη 45°		
Ø		60/100	80/125	110/160	60/100	80/125	110/160	60/100	80/125	110/160
<b>Length of the element</b> Länge des Elements Longitud del elemento Elemenin uzunluğu Μήκος ενδιάμεσου σωλήνα	<b>Without straight part</b> Ohne gerades Stück Sin tramo recto Düz parça olmadan Χωρίς ευθύγραμμο τμήμα	35	35	40	75	90	100	150	150	170
	250 mm	85	85	90	170	185	195	285	285	305
	500 mm	150	150	155	295	310	320	460	460	480
	1000 mm	280	280	285	545	560	570	815	815	835

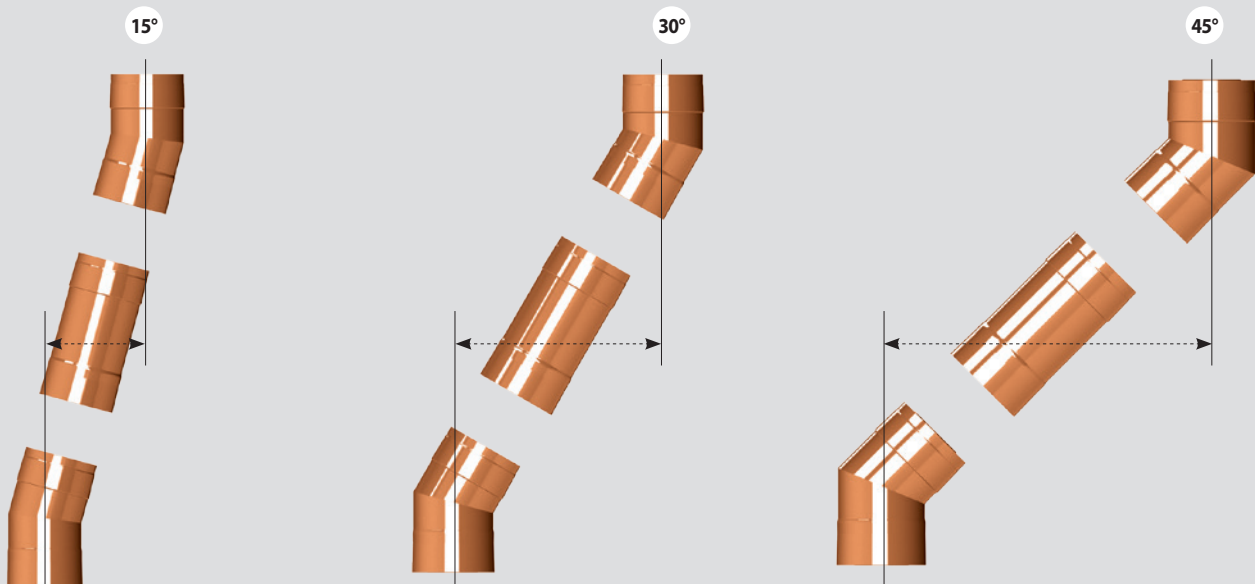

LAM

LAC

# GAS FLUE SYSTEM FOR APPLIANCES NOT DEPENDENT ON AIR COMBUSTION IN A ROOM

LUFT-ABGASSYSTEM FÜR MEHRFACHBELEGUNG

SISTEMA DE EVACUACIÓN COLECTIVO

TOPLUMSAL UYGULAMALAR İÇİN GAZ BACA SİSTEMİ

ΣΥΣΤΗΜΑ ΚΑΠΝΟΔΟΧΟΥ ΠΟΛΛΑΠΛΗΣ ΣΥΝΔΕΣΗΣ ΣΥΣΚΕΥΩΝ ΠΟΥ ΔΕΝ ΕΞΑΡΤΩΝΤΑΙ ΑΠΟ ΤΟΝ ΑΕΡΑ ΚΑΥΣΗΣ ΤΟΥ ΧΩΡΟΥ, ΤΥΠΟΥ "C" (EN 13384-2)

**LAS**

PPH – black

PPH – schwarz · PPH – negro

PPH – siyah · PPH – μαύρο

## Var.1 - Ø60 – 315 mm

with branch • mit Abzweiger • con rama • dal ile • με διακλάδωση 87° Ø60 – 250 mm

1	PPSAS2
2	PPFR60
3	PBRM12
4	LPU(L,B,K)05
5	LPS(L,B,K)25
6	LPW(L,B)5/UPRKW5
7	LPMS(L,B,K)5
8	LPR(L,B,K)05
9	PBTE52
10	PBTK82
11	ZUWK01
12	PBKFS2
13	PBMA02
14	ADKBUK
15	ZUOS32
16	PBAS52
17	ESTBS5

If necessary, place the backflow valve directly into the flue pipe, or instead of collector pipe with 87° branch, you may use the collector pipe with 87° branch and BV.

Falls nötig, die Abgasklappe ins Rauchrohr stellen, oder statt des Kaskadenrohrs 87° das Kaskadenrohr 87° mit Abgasklappe verwenden.

Si es necesario, colocar la válvula antiretorno en el conducto de humos o utilice directamente el tubo en cascada 87° con válvula antiretorno en lugar del tubo en cascada de 87° sin VA.

Gerekirse, çek valfi baca borusuna takın veya baca veya çek valfli 87° kademeli boru kullanın. 87° kaskad yerine çek valfli 87° kaskad baca borusu VA olmadan 87° kademeli baca borusu yerine.

Εάν είναι απαραίτητο, η αντεπίστροφη βαλβίδα μπορεί να τοποθετηθεί στον σωλήνα του καπναγωγού αντί του σωλήνα με διακλάδωση 87°, προσθετα υλικά σύνδεσης θα βρείτε στο σύστημα CAS.

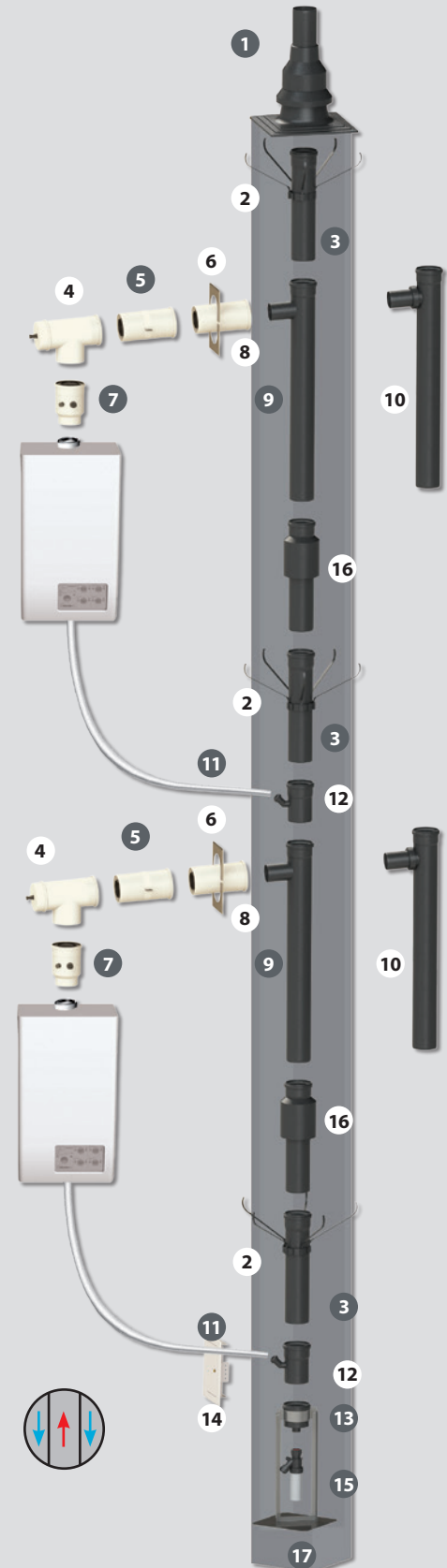

**When assembling horizontal piping, it is necessary to create a slope towards the boiler at minimum of 3°.**

Gefälle schaffen waagerechte Verbindungsleitung muss zum Kessel immer ein Gefälle von mindestens 3° haben.

Al montar las tuberías horizontales, es necesario crear una pendiente hacia la caldera de un mínimo de 3°.

Yatay boru tesisatını monte ederken aşağıdaki kileri yapmak gerekir Kazana doğru en az 3°'lik bir eğim oluşturun.

Κατά την εγκατάσταση οριζόντιων σωληνώσεων, πρέπει να υπάρχει κλίση προς τον λέβητα τουλάχιστον 3°.

**To neutralise the acidic condensates, use the neutralisation box.**

Zur Neutralisierung der sauren Kondensate, die Neutralisationsbox verwenden.

Para neutralizar los ácidos de los condensados, utilice nuestra Box-Neutralización.

Asidik yoğuşmaları nötralize etmek için nötralizasyon kutusu.

Για την ουδετεροποίηση των όξινων συμπυκνωμάτων, χρησιμοποιήστε ένα κουτί εξουδετέρωσης που θα βρείτε στο κεφάλαιο ZUB.



LAS

# GAS FLUE SYSTEM FOR APPLIANCES NOT DEPENDENT ON AIR COMBUSTION IN A ROOM

LUFT-ABGASSYSTEM FÜR MEHRFACHBELEGUNG

SISTEMA DE EVACUACIÓN COLECTIVO

TOPLUMSAL UYGULAMALAR İÇİN GAZ BACA SİSTEMİ

ΣΥΣΤΗΜΑ ΚΑΠΝΟΔΟΧΟΥ ΠΟΛΛΑΠΛΗΣ ΣΥΝΔΕΣΗΣ ΣΥΣΚΕΥΩΝ ΠΟΥ ΔΕΝ ΕΞΑΡΤΩΝΤΑΙ ΑΠΟ ΤΟΝ ΑΕΡΑ ΚΑΥΣΗΣ ΤΟΥ ΧΩΡΟΥ, ΤΥΠΟΥ "C" (EN 13384-2)

**LAS**

PPH – black

PPH – schwarz · PPH – negro

PPH – siyah · PPH – μαύρο

## Var.1 - Ø60 – 315 mm

with branch • mit Abzweiger • con rama • dal ile • με διακλάδωση 87° Ø60 – 250 mm

STARR Collector pipe 87° branch							
STARR Kaskadenrohr 87° • STARR Colector 87° • STARR Kollektör borusu 87° branşman • STARR Σωλήνας με διακλάδωση 87°							
Ø	Code Código	Kod Κωδ.	a (mm)	b (mm)	c (mm)	d (mm)	i
80/60	PBTE58		81	62	938	65	
100/60	PBTE5X		101	63	937	65	
100/80	PBTE8X		101	63	937	70	
110/60	PBTE51		111	73	927	65	
110/80	PBTE81		111	73	927	70	
125/60	PBTE52		127	75	925	65	
125/80	PBTE82		127	75	925	70	
160/60	PBTE56		162	85	915	65	
160/80	PBTE86		162	85	915	70	
200/60	PBTE50		203	150	850	65	
200/80	PBTE80		203	150	850	70	
250/60	PBTE5V		254	260	740	65	
250/80	PBTE8V		254	260	740	70	
315/60	PBTE53		319	290	710	65	
315/80	PBTE83		319	290	710	70	

STARR Collector pipe 87° branch with BV							
STARR Kaskadenrohr 87° mit Abgasklappe • STARR Colector 87° con válv. antiretorno • STARR Kollektör borusu BV ile 87° branşman • STARR Σωλήνας με διακλάδωση 87° και BV (αντεπίστροφη βαλβίδα)							
Ø	Code Código	Kod Κωδ.	a (mm)	b (mm)	c (mm)	d (mm)	i
100/80	PBTK8X		101	73	927	110	
110/80	PBTK81		111	73	927	110	
125/80	PBTK82		127	75	925	110	
160/80	PBTK86		162	85	915	110	
200/80	PBTK80		203	150	850	110	
250/80	PBTK8V		254	260	740	110	
315/80	PBTK83		319	290	710	110	
160/125	PBTK26		162	85	915	160	
200/125	PBTK20		203	150	850	160	
250/125	PBTK2V		254	260	740	160	
315/125	PBTK23		319	290	710	160	

STARR Collector pipe 87° branch for lining							
STARR Kaskadenrohr 87° mit Anschlussrohr • STARR Colector 87° con tubo conexión • STARR Kollektör borusu 87° astar için branşman • STARR Σωλήνας με διακλάδωση 87° με προέκταση							
Ø	Code Código	Kod Κωδ.	a (mm)	b (mm)	c (mm)	d (mm)	i
110/60	PBTRL51		111	73	927	500	
110/80	PBTRL81		111	73	927	500	
125/60	PBTRL52		127	75	925	500	
125/80	PBTRL82		127	75	925	500	
160/60	PBTRL56		162	85	915	500	
160/80	PBTRL86		162	85	915	500	
200/60	PBTRL50		254	260	740	500	
200/80	PBTRL80		254	260	740	500	

LAS



# GAS FLUE SYSTEM FOR APPLIANCES NOT DEPENDENT ON AIR COMBUSTION IN A ROOM

LAS

LUFT-ABGASSYSTEM FÜR MEHRFACHBELEGUNG

PPH – black

SISTEMA DE EVACUACIÓN COLECTIVO

PPH – schwarz · PPH – negro

TOPLUMSAL UYGULAMALAR İÇİN GAZ BACA SİSTEMİ

PPH – siyah · PPH – μαύρο

ΣΥΣΤΗΜΑ ΚΑΠΝΟΔΟΧΟΥ ΠΟΛΛΑΠΛΗΣ ΣΥΝΔΕΣΗΣ ΣΥΣΚΕΥΩΝ ΠΟΥ ΔΕΝ ΕΞΑΡΤΩΝΤΑΙ ΑΠΟ ΤΟΝ ΑΕΡΑ ΚΑΥΣΗΣ ΤΟΥ ΧΩΡΟΥ, ΤΥΠΟΥ "C" (EN 13384-2)

## Var.1 - Ø60 – 315 mm

with branch • mit Abzweiger • con rama • dal ile • με διακλάδωση 87° Ø60 – 250 mm

### STARR Absorber

STARR Absorber • STARR Tramo compensación • STARR Emici • STARR Αντιδιαστολικό

Ø	Code Código	Kod Κωδ.	a (mm)	b (mm)	c (mm)	d (mm)	i
60	PBAS55		61	60	500	-	
80	PBAS58		81	80	500	-	
100	PBAS5X		101	100	500	-	
110	PBAS51		111	110	500	-	
125	PBAS52		127	125	500	-	
160	PBAS56					-	
200	PBAS50					-	
250	PBAS5V					-	
315	PBAS53					-	

### STARR Condensation drain (sloped)

STARR Kondensatfalle m. Anschl. 45° • STARR Descarga condensados conex. 45° • STARR Yoğuşma tahliyesi (eğimli) • STARR Αποστράγγιση συμπυκνωμάτων (κεκλιμένη)

Ø	Code Código	Kod Κωδ.	a (mm)	b (mm)	c (mm)	d (mm)	i
60	PBKFS5		61	55	105	25	
80	PBKFS8		81	62	110	25	
100	PBKFSX		101	63	105	25	
110	PBKFS1		111	73	105	25	
125	PBKFS2		127	75	105	25	
160	PBKFS6		162	85	100	25	
200	PBKFS0		203	150	160	25	
250	PBKFSV		254	260	-	25	
315	PBKFS3		319	290	-	25	

### STARR Socket with drain

STARR Muffe m. Ablauf • STARR Manguito con desc./cond. • STARR Drenajlı Priz • STARR Αποστράγγιση με υποδοχή

Ø	Code Código	Kod Κωδ.	a (mm)	b (mm)	c (mm)	d (mm)	i
60	PBMA05		63	75	20	40	
80	PBMA08		68	85	20	40	
100	PBMA0X		63	70	20	40	
110	PBMA01		63	65	20	40	
125	PBMA02		75	70	20	40	
160	PBMA06		85	70	20	40	
200	PBMA00		150	150	20	40	
250	PBMA0V						
315	PBMA03						

### ZUB Siphon (for pressure M1)

ZUB Siphon (für Überdruck M1) • ZUB Sifón (sobrepresión M1) • ZUB Sifon (M1 basıncı için) • ZUB Σιφόνι (για υπερπίεση M1)

Ø	Code Código	Kod Κωδ.	a (mm)	b (mm)	c (mm)	d (mm)	i
32 mm	ZUOS32		45	25	210	100	
-	-		-	-	-	-	



LAS

# GAS FLUE SYSTEM FOR APPLIANCES NOT DEPENDENT ON AIR COMBUSTION IN A ROOM

**LAS**

PPH – black

PPH – schwarz · PPH – negro

PPH – siyah · PPH – μαύρο

LUFT-ABGASSYSTEM FÜR MEHRFACHBELEGUNG

SISTEMA DE EVACUACIÓN COLECTIVO

TOPLUMSAL UYGULAMALAR İÇİN GAZ BACA SİSTEMİ

ΣΥΣΤΗΜΑ ΚΑΠΝΟΔΟΧΟΥ ΠΟΛΛΑΠΛΗΣ ΣΥΝΔΕΣΗΣ ΣΥΣΚΕΥΩΝ ΠΟΥ ΔΕΝ ΕΞΑΡΤΩΝΤΑΙ ΑΠΟ ΤΟΝ ΑΕΡΑ ΚΑΥΣΗΣ ΤΟΥ ΧΩΡΟΥ, ΤΥΠΟΥ "C" (EN 13384-2)

## Var.1 - Ø60 – 315 mm

with branch · mit Abweiger · con rama · dal ile · με διακλάδωση 87° Ø60 – 250 mm

ZUB Ground support for socket with drain							
ZUB Bodenstütze f. Ablauf mit Muffe · ZUB Base apoyo para manguito con desc./cond. · ZUB Drenajlı soket için zemin desteği · ZUB Βάση στήριξης καμινάδας							
Ø	Code Código	Kod Κωδ.	a (mm)	b (mm)	c (mm)	d (mm)	ⓘ
60	ESTBS5		106	500	-	-	
80	ESTBS8		131	500	-	-	
110	ESTBS1		165	500	-	-	
125	ESTBS2		180	500	-	-	
160	ESTBS6		-	-	-	-	
200	ESTBS0		-	-	-	-	

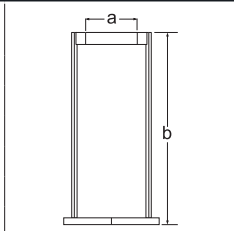

The additional items required for mounting the LAS (variant 1) are included in the STARR, FLEX, LIL, LIB, CAS and ZUB systems.

Die zusätzlichen für die Montage des LAS (Variante 1) notwendigen Artikel sind in den Systemen STARR, FLEX, LIL, LIB, CAS und ZUB enthalten.

Los componentes adicionales necesarios para completar el montaje del sistema LAS (variante 1) están disponibles en los sistemas STARR, FLEX, LIL, LIB, CAS y ZUB.

LAS (varyant 1) montajı için gerekli ek öğeler STARR, FLEX, LIL, LIB, CAS ve ZUB sistemlerine dahildir.

Υπόλοιπα εξαρτήματα που είναι απαραίτητα για την ολοκλήρωση του συστήματος LAS περιέχονται στα συστήματα STARR, FLEX, LIL, LIB, LIK, CAS ή πιθανώς ZUB.

**Δεν κατασκευάσαμε ένα νέο σύστημα καπνοδόχου, το βελτιώσαμε !**

# CONCENTRIC GAS FLUE SYSTEM FOR APPLIANCES NOT DEPENDENT ON AIR COMBUSTION IN A ROOM

**LAS**

KONZENTRISCHES LUFT-ABGASSYSTEM FÜR MEHRFACHBELEGUNG

SISTEMA DE EVACUACIÓN COLECTIVO CONCÉNTRICO

BİR ODADA HAVA YANMASINA BAĞLI OLMAYAN CİHAZLAR İÇİN EŞ MERKEZLİ GAZ BACA SİSTEMİ

ΣΥΣΤΗΜΑ ΚΑΠΝΟΔΟΧΟΥ ΠΟΛΛΑΠΛΗΣ ΣΥΝΔΕΣΗΣ ΣΥΣΚΕΥΩΝ, ΤΥΠΟΥ "C" (EN 13384-2)

## Var.2 - Ø80/125 - 200/300 mm

with branch • mit Abzweiger • con rama • dal ile • με διακλάδωση 87° Ø60/100, 80/125 mm

PPH/steel - white powder coated

PPH/Edelstahl weiss pulverbeschichtet

PPH/acero inoxidable en epoxi blanco

PPH/paslanmaz çelik - beyaz toz boya

PPH/χάλυβας - ηλεκτροστατική βαφή

PPH/stainless steel - polished

PPH/Edelstahl hochglanz • PPH/acero inoxidable pulido  
PPH/paslanmaz çelik - cilalı • PPH/ανοξειδωτος χάλυβας

1	APMS(L,B)2
2	LPR(L,B)12
3	LPUM(L,B,K)5
4	LPS(L,B,K)25
5	LPMS(L,B,K)5
6	LPR(L,B,K)05
7	LPTE(L,B)52
8	ZUWK01
9	LPK(L,B)52
10	LPMA(L,B)2
11	ADKBUK
12	ZUOS32
13	LPAS(L,B)2
14	LPTK(L,B)82
15	ESTBS8

If necessary, place the backflow valve directly into the flue pipe, or instead of collector pipe with 87° branch, you may use the collector pipe with 87° branch and BV.

Falls nötig, die Abgasklappe ins Rauchrohr stellen, oder statt des Kaskadenrohrs 87° das Kaskadenrohr 87° mit Abgasklappe verwenden.

Si es necesario, colocar la válvula antiretorno en el conducto de humos o utilice directamente el tubo en cascada 87° con válvula antiretorno en lugar del tubo en cascada de 87° sin VA.

Gerekirse, baca gazı damperini baca borusuna yerleştirin. veya 87° kademeli boru yerine baca gazı klapeli 87° kademeli boru kullanın. 87° kademeli boru yerine baca gazı klapeli 87° kademeli boru kullanın.

Εάν είναι απαραίτητο, η αντεπίστροφη βαλβίδα μπορεί να τοποθετηθεί στον σωλήνα του καπναγωγού αντί του σωλήνα με διακλάδωση 87°, προσθετα υλικά σύνδεσης θα βρείτε στο σύστημα CAS.

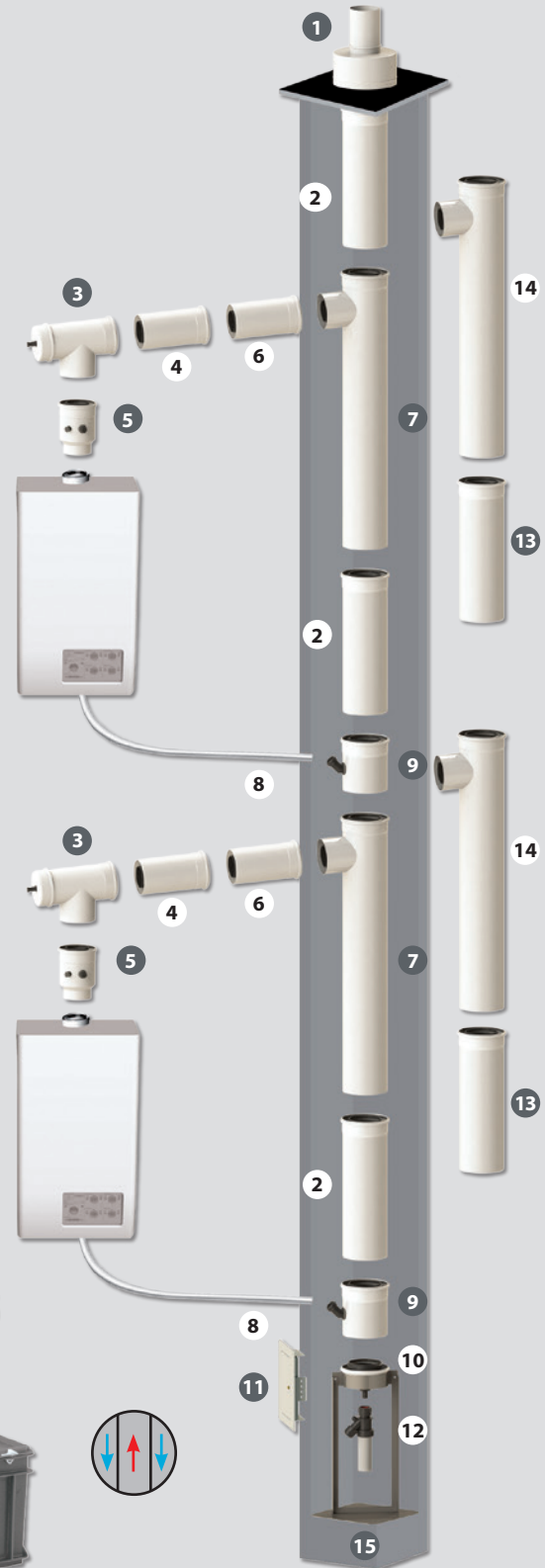

**When assembling horizontal piping, it is necessary to create a slope towards the boiler at minimum of 3°.**

Gefälle schaffen waagerechte Verbindungsleitung muss zum Kessel immer ein Gefälle von mindestens 3° haben.

Al montar las tuberías horizontales, es necesario crear una pendiente hacia la caldera de un mínimo de 3°.

Yatay boru tesisatını monte ederken aşağıdaki kileri yapmak gerekir Kazana doğru en az 3°'lik bir eğim oluşturun.

Κατά την εγκατάσταση οριζόντιων σωληνώσεων, πρέπει να υπάρχει κλίση προς τον λέβητα τουλάχιστον 3°.

**To neutralise the acidic condensates, use the neutralisation box.**

Zur Neutralisierung der sauren Kondensate, die Neutralisationsbox verwenden.

Para neutralizar los ácidos de los condensados, utilice nuestra Box-Neutralización.

Asidik yoğuşmaları nötraleze etmek için nötralizasyon kutusu.

Για την ουδετεροποίηση των όξινων συμπυκνωμάτων, χρησιμοποιήστε ένα κουτί εξουδετέρωσης που θα βρείτε στο κεφάλαιο ZUB.



LAS

# CONCENTRIC GAS FLUE SYSTEM FOR APPLIANCES NOT DEPENDENT ON AIR COMBUSTION IN A ROOM

**LAS**

KONZENTRISCHES LUFT-ABGASSYSTEM FÜR MEHRFACHBELEGUNG

SISTEMA DE EVACUACIÓN COLECTIVO CONCÉNTRICO

BİR ODADA HAVA YANMASINA BAĞLI OLMAYAN CİHAZLAR İÇİN EŞ MERKEZLİ GAZ BACA SİSTEMİ

ΣΥΣΤΗΜΑ ΚΑΠΝΟΔΟΧΟΥ ΠΟΛΛΑΠΛΗΣ ΣΥΝΔΕΣΗΣ ΣΥΣΚΕΥΩΝ, ΤΥΠΟΥ "C" (EN 13384-2)

## Var.2 - Ø80/125 - 200/300 mm

with branch • mit Abzweiger • con rama • dal ile • με διακλάδωση 87° Ø60/100, 80/125 mm

PPH/steel - white powder coated

PPH/Edelstahl weiss pulverbeschichtet

PPH/acero inoxidable en epoxi blanco

PPH/paslanmaz çelik - beyaz toz boya

PPH/χάλυβας - ηλεκτροστατική βαφή

PPH/stainless steel - polished

PPH/Edelstahl hochglanz • PPH/acero inoxidable pulido

PPH/paslanmaz çelik - cilalı • PPH/ανοξειδωτος χάλυβας

**LIL/LIB Pipe with socket**  
LIL/LIB Rohr m. Muffe • LIL/LIB Tubo M/H • LIL/LIB Söketli boru • LIL/LIB Σωλήνα με υποδοχή (κεφάλι)

	Ø	Code Código Kod Κωδ.		a (mm)	b (mm)	c (mm)	d (mm)
		LIL	LIB				
250 mm	60/100	LPRL05	LPRB05	104	52	198	-
	80/125	LPRL08	LPRB08	130	52	198	-
	100/150	LPRL0X	-	153	52	198	-
	110/160	LPRL01	LPRB01	163	52	198	-
	125/180	LPRL02	LPRB02	182	62	188	-
	160/225	LPRL06	LPRB06	227	67	183	-
500 mm	60/100	LPRL55	LPRB55	104	52	448	-
	80/125	LPRL58	LPRB58	130	52	448	-
	100/150	LPRL5X	-	153	52	448	-
	110/160	LPRL51	LPRB51	163	52	448	-
	125/180	LPRL52	LPRB52	182	62	438	-
	160/225	LPRL56	LPRB56	227	67	433	-
1000 mm	60/100	LPRL15	LPRB15	104	52	948	-
	80/125	LPRL18	LPRB18	130	52	948	-
	100/150	LPRL1X	-	153	52	948	-
	110/160	LPRL11	LPRB11	163	52	948	-
	125/180	LPRL12	LPRB12	182	62	938	-
	160/225	LPRL16	LPRB16	227	67	933	-
200/300	LPRL10	LPRB10	302	67	933	-	

**LIL/LIB Collector pipe 87° branch w/o BV**  
LIL/LIB Kaskadenrohr 87° ohne Abgasklappe • LIL/LIB Colector 87° sin VA • LIL/LIB Kollektör borusu BV'siz 87° branşman  
• LIL/LIB Σωλήνας με διακλάδωση 87°

	Ø	Code Código Kod Κωδ.		a (mm)	b (mm)	c (mm)	d (mm)	
		LIL	LIB					
* branch 60/100	60/100	LPTEL55	LPTEB55	60	52	948	82	
	80/125	LPTEL58	LPTEB58	80	52	948	82	
	100/150	LPTEL5X	-	100	52	948	85	
	110/160	LPTEL51	LPTEB51	110	52	948	85	
	125/180	LPTEL52	LPTEB52	125	62	938	87	
	160/225	LPTEL56	LPTEB56	160	67	933	92	
	200/300	LPTEL50	LPTEB50	200	67	933	110	
	* branch 80/125	80/125	LPTEL88	LPTEB88	80	52	948	125
		100/150	LPTEL8X	-	100	52	948	125
		110/160	LPTEL81	LPTEB81	110	52	948	125
125/180		LPTEL82	LPTEB82	125	62	938	127	
160/225		LPTEL86	LPTEB86	160	67	933	132	
200/300		LPTEL80	LPTEB80	200	67	933	150	

**LIL/LIB Collector pipe 87° branch with BV**  
LIL/LIB Kaskadenrohr 87° mit Abgasklappe • LIL/LIB Colector 87° con VA • LIL/LIB Kollektör borusu BV ile 87° branşman • LIL/LIB Σωλήνας με διακλάδωση 87° και BV (αντεπίστροφη βαλβίδα)

	Ø	Code Código Kod Κωδ.		a (mm)	b (mm)	c (mm)	d (mm)	
		LIL	LIB					
* branch 80/125	80/125	LPTKL88	LPTKB88	80	52	948	125	
	100/150	LPTKL8X	-	100	52	948	125	
	110/160	LPTKL81	LPTKB81	110	52	948	125	
	125/180	LPTKL82	LPTKB82	125	62	938	127	
	160/225	LPTKL86	LPTKB86	160	67	933	132	
	200/300	LPTKL80	LPTKB80	200	67	933	150	
	* branch 125/180	125/180	LPTKL22	LPTKB22	125	62	938	127
		160/225	LPTKL26	LPTKB26	160	67	933	132
		200/300	LPTKL20	LPTKB20	200	67	933	150
		-	-	-	-	-	-	-
-		-	-	-	-	-	-	

\* branch • Abzweiger • rama • branşman • διακλάδωση

# CONCENTRIC GAS FLUE SYSTEM FOR APPLIANCES NOT DEPENDENT ON AIR COMBUSTION IN A ROOM

**LAS**

KONZENTRISCHES LUFT-ABGASSYSTEM FÜR MEHRFACHBELEGUNG

SISTEMA DE EVACUACIÓN COLECTIVO CONCÉNTRICO

BİR ODADA HAVA YANMASINA BAĞLI OLMAYAN CİHAZLAR İÇİN EŞ MERKEZLİ GAZ BACA SİSTEMİ

ΣΥΣΤΗΜΑ ΚΑΠΝΟΔΟΧΟΥ ΠΟΛΛΑΠΛΗΣ ΣΥΝΔΕΣΗΣ ΣΥΣΚΕΥΩΝ, ΤΥΠΟΥ "C" (EN 13384-2)

## Var.2 - Ø80/125 - 200/300 mm

with branch • mit Abzweiger • con rama • dal ile • με διακλάδωση 87° Ø60/100, 80/125 mm

PPH/steel - white powder coated

PPH/Edelstahl weiss pulverbeschichtet

PPH/acero inoxidable en epoxi blanco

PPH/paslanmaz çelik - beyaz toz boya

PPH/χάλυβας - ηλεκτροστατική βαφή

PPH/stainless steel - polished

PPH/Edelstahl hochglanz • PPH/acero inoxidable pulido

PPH/paslanmaz çelik - cilalı • PPH/ανοξειδωτος χάλυβας

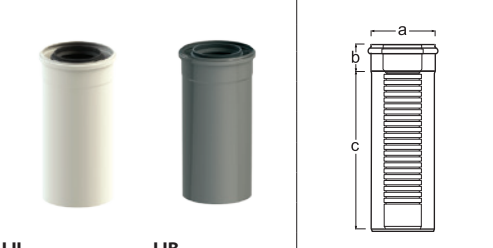
<b>LIL/LIB Absorber</b>							
LIL/LIB Absorber • LIL/LIB Tramo compensación • LIL/LIB Emici • LIL/LIB Αντιδιαστολικό							
	Ø	Code Código Kod Κωδ.		a (mm)	b (mm)	c (mm)	d (mm)
		LIL	LIB				
	60/100	LPASL5	LPASB5	104	52	448	-
	80/125	LPASL8	LPASB8	130	52	448	-
	100/150	LPASLX	-	153	52	448	-
	110/160	LPASL1	LPASB1	163	52	448	-
	125/180	LPASL2	LPASB2	182	62	438	-
	160/225	LPASL6	LPASB6	227	67	433	-
	200/300	LPASL0	LPASB0	302	67	433	-

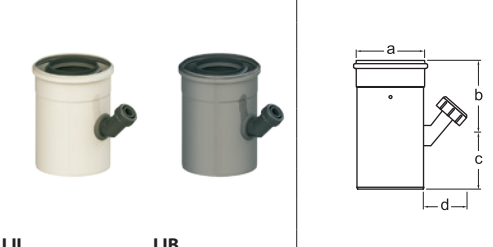
<b>LIL/LIB Condensation drain (sloped)</b>							
LIL/LIB Kondensatfalle m. Anschl. 45° • LIL/LIB Desc./condensados (conex. 45°) • LIL/LIB Yoğuşma tahliyesi (eğimli) • LIL/LIB Αποστράγγιση συμπυκνωμάτων							
	Ø	Code Código Kod Κωδ.		a (mm)	b (mm)	c (mm)	d (mm)
		LIL	LIB				
	60/100	LPKLS5	LPKBS5	104	80	60	-
	80/125	LPKLS8	LPKBS8	130	82	60	-
	100/150	LPKLSX	-	153	82	60	-
	110/160	LPKLS1	LPKBS1	163	82	60	-
	125/180	LPKLS2	LPKBS2	-	-	-	-
	160/225	LPKLS6	LPKBS6	-	-	-	-
	200/300	LPKLS0	LPKBS0	-	-	-	-

<b>LIL/LIB Socket with drain</b>							
LIL/LIB Muffe m. Ablauf • LIL/LIB Manguito con desc./cond. • LIL/LIB Drenajlı Priz • LIL/LIB Αποστράγγιση με υποδοχή							
	Ø	Code Código Kod Κωδ.		a (mm)	b (mm)	c (mm)	d (mm)
		LIL	LIB				
	60/100	LPMAL5	LPMAB5	65	70	32	40
	80/125	LPMAL8	LPMAB8	70	75	32	40
	100/150	LPMALX	-	70	70	32	40
	110/160	LPMAL1	LPMAB1	70	70	32	40
	125/180	LPMAL2	LPMAB2	70	65	32	40
	160/225	LPMAL6	LPMAB6	90	65	32	40
	200/300	LPMAL0	LPMAB0	120	85	32	40

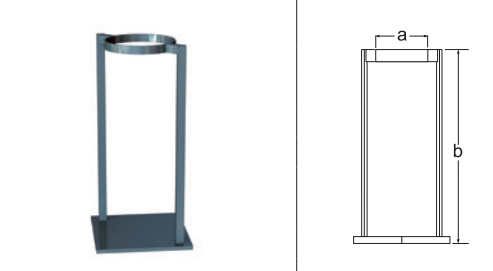
<b>ZUB Ground support for socket with drain</b>									
ZUB Bodenstütze f. Ablauf mit Muffe • ZUB Base apoyo para manguito con desc./cond. • ZUB Drenajlı soket için zemin desteği • ZUB Βάση στήριξης καμινάδας									
	Ø	Code Código Kod Κωδ.		a (mm)	b (mm)	c (mm)	d (mm)	i	
		LIL	LIB						
	60/100	ESTBSX	-	-	-	-	-	-	
	80/125	ESTBS2	-	-	-	-	-	-	
	110/160	ESTBS6	-	-	-	-	-	-	
	125/180	ESTBSD2	-	-	-	-	-	-	
	160/225	ESTBSD6	-	-	-	-	-	-	
	200/300	ESTBSD0	-	-	-	-	-	-	
	-	-	-	-	-	-	-	-	
-	-	-	-	-	-	-	-		

LAS

# CONCENTRIC GAS FLUE SYSTEM FOR APPLIANCES NOT DEPENDENT ON AIR COMBUSTION IN A ROOM

**LAS**

KONZENTRISCHES LUFT-ABGASSYSTEM FÜR MEHRFACHBELEGUNG

SISTEMA DE EVACUACIÓN COLECTIVO CONCÉNTRICO

BİR ODADA HAVA YANMASINA BAĞLI OLMAYAN CİHAZLAR İÇİN EŞ MERKEZLİ GAZ BACA SİSTEMİ

ΣΥΣΤΗΜΑ ΚΑΠΝΟΔΟΧΟΥ ΠΟΛΛΑΠΛΗΣ ΣΥΝΔΕΣΗΣ ΣΥΣΚΕΥΩΝ, ΤΥΠΟΥ "C" (EN 13384-2)

## Var.2 - Ø80/125 - 200/300 mm

with branch • mit Abzweiger • con rama • dal ile • με διακλάδωση 87° Ø60/100, 80/125 mm

PPH/steel - white powder coated

PPH/Edelstahl weiss pulverbeschichtet

PPH/acero inoxidable en epoxi blanco

PPH/paslanmaz çelik - beyaz toz boya

PPH/χάλυβας - ηλεκτροστατική βαφή

PPH/stainless steel - polished

PPH/Edelstahl hochglanz • PPH/acero inoxidable pulido

PPH/paslanmaz çelik - cilalı • PPH/ανοξειδωτος χάλυβας

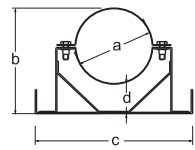

**LAB/LAL Wall bracket (reinforced)**  
LAB/LAL Wandhalterung (verstärkt) • LAB/LAL Soporte mural reforzado • LAB/LAL Duvar braketi (güçlendirilmiş) • LAB/LAL Στήριγμα τοίχου (ενισχυμένο)

	Ø	Code Código Kod Κωδ.		a (mm)	b (mm)	c (mm)	d (mm)
		LAB	LAL				
	60/100	APWHB5	APWHL5	100	150	230	45
	80/125	APWHB8	APWHL8	125	175	225	45
	100/150	-	APWHLX	150	215	295	50
	110/160	APWHB1	APWHL1	160	215	295	50
	125/180	APWHB2	APWHL2	180	230	245	50
	160/225	APWHB6	APWHL6	225	270	285	50
	200/300	APWHB0	APWHL0	300	350	360	50

**LAB/LAL Wall bracket extension (reinforced)**  
LAB/LAL Verlängerung der Wandhalterung (verstärkt) • LAB/LAL Extensión soporte mural • LAB/LAL Duvar braketi uzatması (güçlendirilmiş) • LAB/LAL Προέκταση στηρίγματος τοίχου (ενισχυμένο)

	Ø	Code Código Kod Κωδ.		a (mm)	b (mm)	c (mm)	d (mm)
		LAB	LAL				
	60/100	APVUBU	APVULU	395	85	15	-
	80/125						
	100/150						
	110/160						
	125/180						
	160/225						
	200/300						

**LAB/LAL Top terminal with air intake**  
LAB/LAL Mündungsabschluss m. Zuluft • LAB/LAL Terminal con entrada de aire • LAB/LAL Hava girişli üst terminal • LAB/LAL Άνοιγμα με αναρρόφηση

	Ø	Code Código Kod Κωδ.		a (mm)	b (mm)	c (mm)	d (mm)
		LAB	LAL				
	60/100	APMSB5	APMSL5	160	175	155	340
	80/125	APMSB8	APMSL8	160	120	180	280
	100/150	-	APMSLX	160	120	180	280
	110/160	APMSB1	APMSL1	160	120	180	280
	125/180	APMSB2	APMSL2	170	115	235	280
	160/225	APMSB6	APMSL6	145	125	290	295
	200/300	APMSB0	APMSL0	145	120	390	265

The additional items required for mounting the LAS (variant 2) are included in the LIL, LIB and ZUB systems.

Die zusätzlichen für die Montage des LAS (Variante 2) notwendigen Artikel sind in den Systemen LIL, LIB und ZUB enthalten.

Los componentes adicionales necesarios para completar el montaje del sistema LAS (variante 2) están disponibles en los sistemas LIL, LIB y ZUB.

Ek öğeler montaj için gerekli LAS (varyant 2) dahildir LIL, LIB ve ZUB'da sistemler.

Υπόλοιπα εξαρτήματα που είναι απαραίτητα για την ολοκλήρωση του συστήματος LAS περιέχονται στα συστήματα LIL, LIB ή πιθανώς ZUB.

LAS

# CONCENTRIC GAS FLUE SYSTEM FOR APPLIANCES NOT DEPENDENT ON AIR COMBUSTION IN A ROOM

**LAS**

KONZENTRISCHES LUFT-ABGASSYSTEM FÜR MEHRFACHBELEGUNG

PPH/stainless steel – polished

SISTEMA DE EVACUACIÓN COLECTIVO CONCÉNTRICO

PPH/Edelstahl hochglanz

BİR ODADA HAVA YANMASINA BAĞLI OLMAYAN CİHAZLAR İÇİN EŞ MERKEZLİ GAZ BACA SİSTEMİ

PPH/acero inoxidable pulido

ΣΥΣΤΗΜΑ ΚΑΠΝΟΔΟΧΟΥ ΠΟΛΛΑΠΛΗΣ ΣΥΝΔΕΣΗΣ ΣΥΣΚΕΥΩΝ ΤΥΠΟΥ "C" (EN 13384-2)

PPH/paslanmaz çelik - cilalı

PPH/ανοξειδωτος χάλυβας

## Var.3 - Ø110/160 – 200/300 mm

with branch • mit Abzweiger • con rama • dal ile • με διακλάδωση 87° Ø60/100, 80/125 mm

1	APMSB1
2	APRB1
3	APVB81
4	APWHB1
5	LPSAB(L)8
6	LPRB(L)58
7	LPUB(L)08
8	LPKB(L)01
9	APRTB(L)1
10	APWKB(L)1
11	LPWB(L)01
12	LPKXB(L)6
13	LPRB(L)A8
14	ZUOS32
15	APSDB1

If necessary, place the backflow valve directly into the flue pipe, or instead of collector pipe with 87° branch, you may use the collector pipe with 87° branch and BV.

Falls nötig, die Abgasklappe ins Rauchrohr stellen, oder statt des Kaskadenrohrs 87° das Kaskadenrohr 87° mit Abgasklappe verwenden.

Si es necesario, colocar la válvula antiretorno en el conducto de humos o utilice directamente el tubo en cascada 87° con válvula antiretorno en lugar del tubo en cascada de 87° sin VA.

Gerekirse, baca gazı damperini baca borusuna yerleştirin veya 87° kademeli boru yerine baca gazı damperli 87° kademeli boru kullanın.

Εάν είναι απαραίτητο, η αντεπίστροφη βαλβίδα μπορεί να τοποθετηθεί στον σωλήνα του καπναγωγού αντί του σωλήνα με διακλάδωση 87°, προσθετα υλικά σύνδεσης θα βρείτε στο σύστημα CAS.

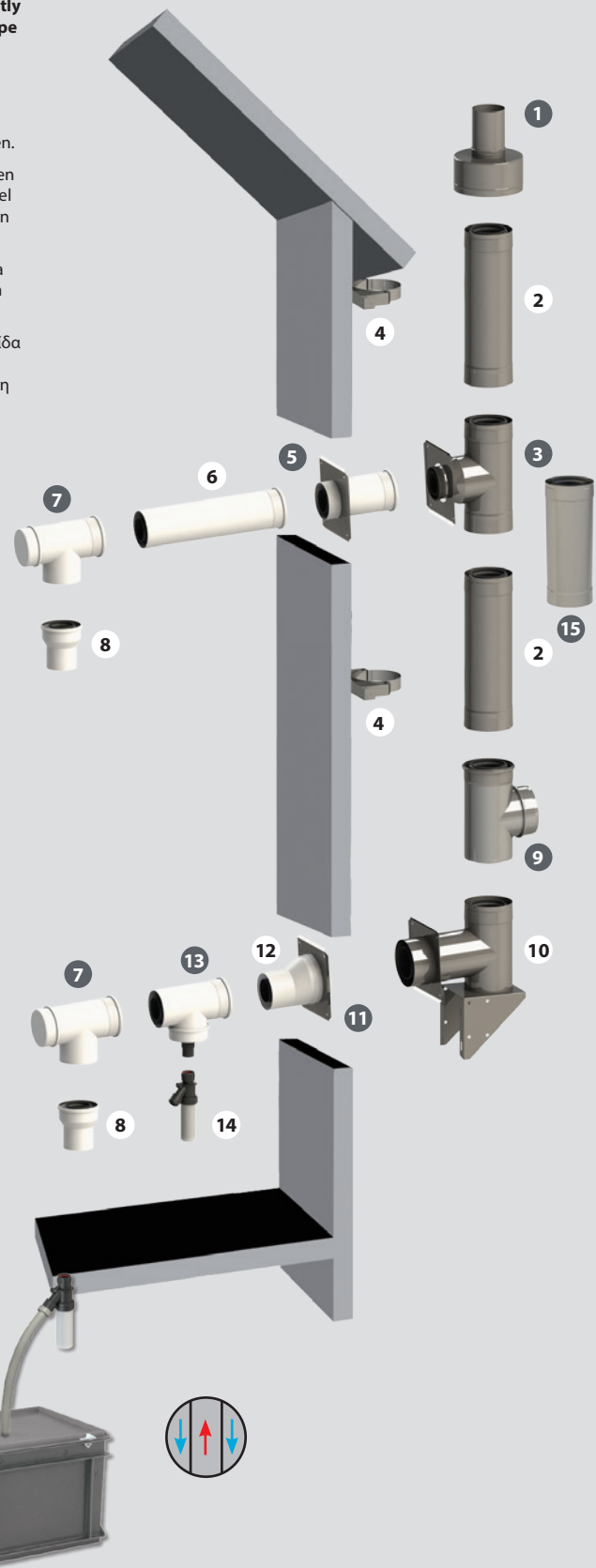

**When assembling horizontal piping, it is necessary to create a slope towards the boiler at minimum of 3°.**

Gefälle schaffen waagerechte Verbindungsleitung muss zum Kessel immer ein Gefälle von mindestens 3° haben.

Al montar las tuberías horizontales, es necesario crear una pendiente hacia la caldera de un mínimo de 3°.

Yatay boru tesisatını monte ederken aşağıdaki kileri yapmak gerekir Kazana doğru en az 3°'lik bir eğim oluşturun.

Κατά την εγκατάσταση οριζόντιων σωληνώσεων, πρέπει να υπάρχει κλίση προς τον λέβητα τουλάχιστον 3°.

**To neutralise the acidic condensates, use the neutralisation box.**

Zur Neutralisierung der sauren Kondensate, die Neutralisationsbox verwenden.

Para neutralizar los ácidos de los condensados, utilice nuestra Box-Neutralización.

Asidik yoğuşmaları nötralize etmek için nötralizasyon kutusu.

Για την ουδετεροποίηση των όξινων συμπυκνωμάτων, χρησιμοποιήστε ένα κουτί εξουδετέρωσης που θα βρείτε στο κεφάλαιο ZUB.

LAS

# CONCENTRIC GAS FLUE SYSTEM FOR APPLIANCES NOT DEPENDENT ON AIR COMBUSTION IN A ROOM

**LAS**

KONZENTRISCHES LUFT-ABGASSYSTEM FÜR MEHRFACHBELEGUNG

PPH/stainless steel – polished

SISTEMA DE EVACUACIÓN COLECTIVO CONCÉNTRICO

PPH/Edelstahl hochglanz

BİR ODADA HAVA YANMASINA BAĞLI OLMAYAN CİHAZLAR İÇİN EŞ MERKEZLİ GAZ BACA SİSTEMİ

PPH/acero inoxidable pulido

ΣΥΣΤΗΜΑ ΚΑΠΝΟΔΟΧΟΥ ΠΟΛΛΑΠΛΗΣ ΣΥΝΔΕΣΗΣ ΣΥΣΚΕΥΩΝ ΤΥΠΟΥ "C" (EN 13384-2)

PPH/paslanmaz çelik - cilalı

PPH/ανοξειδωτος χάλυβας

## Var.3 - Ø110/160 – 200/300 mm

with branch • mit Abzweiger • con rama • dal ile • με διακλάδωση 87° Ø60/100, 80/125 mm

LAB Pipe with socket		LAB Rohr m. Muffe • LAB Tubo M/H • LAB Söketli boru • LAB Σωλήνα με υποδοχή (κεφάλι)						
Ø	Code Código	Kod Κωδ.	a (mm)	b (mm)	c (mm)	d (mm)	i	
250 mm	110/160	APRB01	160	62	188	-		
	125/180	APRB02	180	62	188	-		
	160/225	APRB06	225	62	188	-		
	200/300	APRB00	300	62	188	-		
500 mm	110/160	APRB51	160	62	438	-		
	125/180	APRB52	180	62	438	-		
	160/225	APRB56	225	62	438	-		
	200/300	APRB50	300	62	438	-		
1000 mm	110/160	APRB11	160	62	938	-		
	125/180	APRB12	180	62	938	-		
	160/225	APRB16	225	62	938	-		
	200/300	APRB10	300	62	938	-		

LAB Connecting Tee (reduced)		LAB Verbindungs-T (reduziert) • LAB Te reducida • LAB Bağlantı Teli (azaltılmış) • LAB Ταφ σύνδεσης (συστολικό)						
Ø	Code Código	Kod Κωδ.	a (mm)	b (mm)	c (mm)	d (mm)	i	
* branch 60/100	110/160	APVB51	160	62	100	170		
	125/180	APVB52	180	62	120	190		
	160/225	APVB56	225	62	150	220		
	200/300	APVB50	300	62	150	220		
* branch 80/125	110/160	APVB81	160	62	100	170		
	125/180	APVB82	180	62	120	190		
	160/225	APVB86	225	62	150	220		
	200/300	APVB80	300	62	150	220		

\* branch • Anschluss • Conexión • branşman • διακλάδωση

LAB Absorber		LAB Absorber • LAB Tramo compensación • LAB Emici • LAB Αντιδιαστολικό						
Ø	Code Código	Kod Κωδ.	a (mm)	b (mm)	c (mm)	d (mm)	i	
110/160	APSDB1		160	62	438	-		
125/180	APSDB2		180	62	438	-		
160/225	APSDB6		225	62	438	-		
200/300	APSDB0		225	62	438	-		
-	-		-	-	-	-		
-	-		-	-	-	-		
-	-		-	-	-	-		
-	-		-	-	-	-		

LAB Base support bracket complete		LAB Wandkonsole komplett • LAB Base mural completa • LAB Taban destek braketi tamamlandı • LAB Καμπύλη στερέωσης 87° με βραχίονα στήριξης						
Ø	Code Código	Kod Κωδ.	a (mm)	b (mm)	c (mm)	d (mm)	i	
110/160	APWKB1		160	150	360	220		
125/180	APWKB2		180	160	390	225		
160/225	APWKB6		-	-	-	-		
200/300	APWKB0		-	-	-	-		
-	-		-	-	-	-		
-	-		-	-	-	-		

LAS

# CONCENTRIC GAS FLUE SYSTEM FOR APPLIANCES NOT DEPENDENT ON AIR COMBUSTION IN A ROOM

**LAS**

KONZENTRISCHES LUFT-ABGASSYSTEM FÜR MEHRFACHBELEGUNG

PPH/stainless steel – polished

SISTEMA DE EVACUACIÓN COLECTIVO CONCÉNTRICO

PPH/Edelstahl hochglanz

BİR ODADA HAVA YANMASINA BAĞLI OLMAYAN CİHAZLAR İÇİN EŞ MERKEZLİ GAZ BACA SİSTEMİ

PPH/acero inoxidable pulido



ΣΥΣΤΗΜΑ ΚΑΠΝΟΔΟΧΟΥ ΠΟΛΛΑΠΛΗΣ ΣΥΝΔΕΣΗΣ ΣΥΣΚΕΥΩΝ ΤΥΠΟΥ "C" (EN 13384-2)

PPH/paslanmaz çelik - cilalı

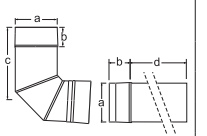

PPH/ανοξειδωτος χάλυβας

## Var.3 - Ø110/160 – 200/300 mm

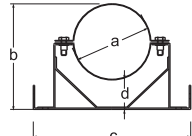

with branch • mit Abzweiger • con rama • dal ile • με διακλάδωση 87° Ø60/100, 80/125 mm

<b>LAB Elbow 87° with pipe</b> LAB Stützbogen 87° m. Rohr • LAB Codo apoyo 87° con tubo • LAB Dırsek 87° borulu • LAB Καμπύλη 87° με προέκταση												
		500 mm	Ø	Code Código	Kod Κωδ.	a (mm)	b (mm)	c (mm)	d (mm)			
			110/160	APSBB1		160	62	250	448			
			125/180	APSBB2		180	62	260	448			
			160/225	APSBB6		225	62	270	448			
			200/300	APSBB0		300	62	270	448			



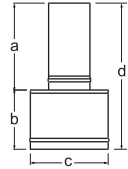

<b>LAB Wall bracket (reinforced)</b> LAB Wandhalterung verstärkt • LAB Soporte mural reforzado • LAB Duvar braketi (güçlendirilmiş) • LAB Στήριγμα τοίχου (ενισχυμένο)										
		Ø	Code Código	Kod Κωδ.	a (mm)	b (mm)	c (mm)	d (mm)		
		110/160	APWHB1		160	215	295	50		
		125/180	APWHB2		180	230	245	50		
		160/225	APWHB6		225	270	285	50		
		200/300	APWHB0		300	350	360	50		



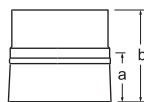

<b>LAB Opening with suction</b> LAB Mündungsabschluss m. Zuluft • LAB Terminal con entrada de aire • LAB Emme ile açılma • LAB Άνοιγμα με αναρρόφηση										
		Ø	Code Código	Kod Κωδ.	a (mm)	b (mm)	c (mm)	d (mm)		
		110/160	APMSB1		160	120	180	280		
		125/180	APMSB2		170	115	235	280		
		160/225	APMSB6		145	125	290	295		
		200/300	APMSB0		145	120	390	265		
		-	-		-	-	-	-		-
		-	-		-	-	-	-		-
		-	-		-	-	-	-		-

<b>LAB Socket (F) for cutted pipes</b> LAB Muffe female z. Rohrkürzung • LAB Manguito (H) pr. tubos cortados • Kesilmiş borular için LAB Soketi (F) • LAB Υποδοχή για κοπή σωλήνα										
		Ø	Code Código	Kod Κωδ.	a (mm)	b (mm)	c (mm)	d (mm)		
		110/160	APMKB1		70	120	-	-		
		125/180	APMKB2		70	120	-	-		
		160/225	APMKB6		70	120	-	-		
		200/300	APMKB0		70	120	-	-		

<b>LIB Pipe with socket</b> LIB Rohr m. Muffe • LIB Tubo M/H • LIB Soketli boru • LIB Σωλήνα με υποδοχή (κεφάλι)											
		250 mm	Ø	Code Código	Kod Κωδ.	a (mm)	b (mm)	c (mm)	d (mm)		
			60/100	LPRB05		104	52	198	-		
			80/125	LPRB08		130	52	198	-		
			-	-		-	-	-	-		-
			-	-		-	-	-	-		-
			-	-		-	-	-	-		-
			-	-		-	-	-	-		-
			-	-		-	-	-	-		-

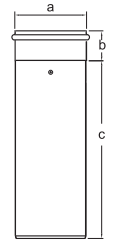
LAS

# CONCENTRIC GAS FLUE SYSTEM FOR APPLIANCES NOT DEPENDENT ON AIR COMBUSTION IN A ROOM

**LAS**

KONZENTRISCHES LUFT-ABGASSYSTEM FÜR MEHRFACHBELEGUNG

PPH/stainless steel – polished

SISTEMA DE EVACUACIÓN COLECTIVO CONCÉNTRICO

PPH/Edelstahl hochglanz

BİR ODADA HAVA YANMASINA BAĞLI OLMAYAN CİHAZLAR İÇİN EŞ MERKEZLİ GAZ BACA SİSTEMİ

PPH/acero inoxidable pulido

ΣΥΣΤΗΜΑ ΚΑΠΝΟΔΟΧΟΥ ΠΟΛΛΑΠΛΗΣ ΣΥΝΔΕΣΗΣ ΣΥΣΚΕΥΩΝ ΤΥΠΟΥ "C" (EN 13384-2)

PPH/paslanmaz çelik - cilalı

PPH/ανοξειδωτος χάλυβας

## Var.3 - Ø110/160 – 200/300 mm

with branch • mit Abzweiger • con rama • dal ile • με διακλάδωση 87° Ø60/100, 80/125 mm

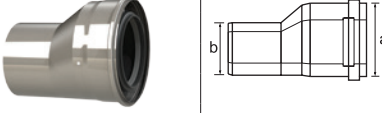
LIB Boiler adapter eccentric LIB Kesselanschluss exzentrisch • LIB Adapt. caldera excéntrico • LIB Kazan adaptörü eksantrik • LIB Συστολή λέβητα - έκκεντρη									
	Ø	Code Código	Kod Κωδ.	a (mm)	b (mm)	c (mm)	d (mm)	i	
	* socket 110/160	60/100	LPKXB51	160	100	-	-		
		80/125	LPKXB81	160	125	-	-		
		-	-	-	-	-	-	-	
		-	-	-	-	-	-	-	
	* socket 125/180	60/100	LPKXB52	180	100	-	-		
		80/125	LPKXB82	180	125	-	-		
		-	-	-	-	-	-	-	
		-	-	-	-	-	-	-	
	* socket 160/225	60/100	LPKXB56	225	100	-	-		
		80/125	LPKXB86	225	125	-	-		
		-	-	-	-	-	-	-	
		-	-	-	-	-	-	-	
* socket 200/300	60/100	LPKXB50	300	100	-	-			
	80/125	LPKXB80	300	125	-	-			
	-	-	-	-	-	-	-		
	-	-	-	-	-	-	-		

\* socket • Muffe • Manguito • Soket • υποδοχή

**The additional items required for mounting the LAS (variant 3) are included in the LAB, LIB and ZUB systems.**

Die zusätzlichen für die Montage des LAS (Variante 3) notwendigen Artikel sind in den Systemen LAB, LIB und ZUB enthalten.

Los componentes adicionales necesarios para completar el montaje del sistema LAS (variante 3) estan disponibles en los sistemas LAB, LIB y ZUB.

Ek öğeler montaj için gerekli LAS (varyant 3) dahildir LAB, LIB ve ZUB'da sistemler.

Υπόλοιπα εξαρτήματα που είναι απαραίτητα για την ολοκλήρωση του συστήματος LAS περιέχονται στα συστήματα LIB, LIB ή πιθανώς ZUB.

LAS

## GAS FLUE SYSTEM FOR APPLIANCES CONNECTED TO CASCADE

ABGASSYSTEM FÜR KASKADE

SISTEMA DE EVACUACIÓN EN CASCADA

KASKAD'A BAĞLI CİHAZLAR İÇİN GAZ BACA SİSTEMİ

ΣΥΣΤΗΜΑ ΚΑΠΝΟΔΟΧΩΝ ΓΙΑ ΣΥΣΚΕΥΕΣ ΣΕ ΣΥΣΤΟΙΧΙΑ, CASCADE

CAS

PPH – black

PPH – schwarz · PPH – negro

PPH – siyah · PPH – μαύρο

### Var.1 - Ø80 – 315 mm

with branch · mit Abzweiger · con rama · dal ile · με διακλάδωση 45°, 87° Ø60 – 250 mm

AXIAL	
1	PBTU01
2	PBRTA1
3	ZUOS32
4	PBTK81
5	PBRM08
6	PPEK01

#### Cascade type AXIAL with backflow valves.

Kaskade Type AXIAL mit Abgasklappen.

Cascada tipo AXIAL con válvulas antiretorno.

Geri akış valfli kaskad tip AXIAL.

Συστοιχία τύπου AXIAL με αντεπίστροφες βαλβίδες.



OFFSET	
1	PBTU01
2	PBRK81
3	PBRB98
4	PBRM08
5	PBEKA1

#### Cascade type OFFSET without backflow valves.

Kaskade Type OFFSET ohne Abgasklappen.

Cascada tipo OFFSET sin válvulas antiretorno.

Geri akış valfli olmadan kademeli tip OFFSET.

Συστοιχία τύπου OFFSET χωρίς αντεπίστροφες βαλβίδες.



CAS

**When assembling horizontal piping, it is necessary to create a slope towards the boiler at minimum of 3°.**

Gefälle schaffen waagerechte Verbindungsleitung muss zum Kessel immer ein Gefälle von mindestens 3° haben.

Al montar las tuberías horizontales, es necesario crear una pendiente hacia la caldera de un mínimo de 3°.

Yatay boru tesisatını monte ederken aşağıdakileri yapmak gerekir Kazana doğru en az 3°'lik bir eğim oluşturun.

Κατά την εγκατάσταση οριζόντιων σωληνώσεων, πρέπει να υπάρχει κλίση προς τον λέβητα τουλάχιστον 3°.



# GAS FLUE SYSTEM FOR APPLIANCES CONNECTED TO CASCADE

CAS

ABGASSYSTEM FÜR KASKADE

PPH – black

SISTEMA DE EVACUACIÓN EN CASCADA

PPH – schwarz · PPH – negro

KASKAD'A BAĞLI CİHAZLAR İÇİN GAZ BACA SİSTEMİ

PPH – siyah · PPH – μαύρο

ΣΥΣΤΗΜΑ ΚΑΠΝΟΔΟΧΩΝ ΓΙΑ ΣΥΣΚΕΥΕΣ ΣΕ ΣΥΣΤΟΙΧΙΑ, CASCADE

## Var.1 - Ø80 – 315 mm

with branch · mit Abzweiger · con rama · dal ile · με διακλάδωση 45°, 87° Ø60 – 250 mm

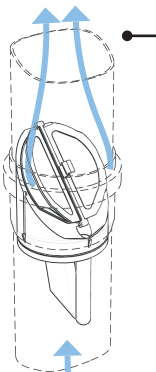
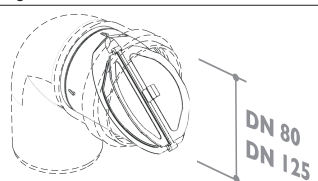
Options of installation of backflow valve (BV)	Installation der Abgasklappe	Instalación de la válvula antiretorno	Kurulum seçenekleri geri akış valfinin (BV)	Επιλογές εγκατάστασης της αντεπίστροφης βαλβίδας (BV)
<b>Proprietary backflow valve may be placed into any and all elements of the Almeva gas flue system with Ø80.</b>	Die patentierte Abgasklappe passt in jedes beliebige Element des Abgassystems Almeva (Ø80).	La válvula antiretorno patentada se adapta a cualquier elemento del sistema de evacuación Almeva (Ø80).	Patentli çek valf, Almeva Ø80 sisteminin herhangi bir yerine takılabilir.	Η πατενταρισμένη αντεπίστροφη βαλβίδα μπορεί να τοποθετηθεί σε όποιο εξάρτημα του συστήματος Almeva Ø80.
 <p><b>For installation into vertical position for backflow valve a siphon is to be used.</b> Für die vertikale Installation der Abgasklappe den Siphon verwenden. Para la instalación vertical de la válvula antiretorno, utilizar el sifón. Dikey kurulum için Baca gazı damperinin dikey montajı için sifonu kullanın. Σε κατακόρυφη εγκατάσταση η αντεπίστροφη βαλβίδα θα πρέπει να τοποθετείται με το σιφόνι της.</p>	<p><b>For installation into horizontal position for backflow valve a plug is to be used.</b> Für die horizontale Installation der Abgasklappe den Stopfen verwenden. Para la instalación horizontal de la válvula antiretorno, utilizar el tapón.</p>	 <p>Gerçek vana için yatay konuma montaj için a fiş kullanılmalıdır.. Σε οριζόντια εγκατάσταση η αντεπίστροφη βαλβίδα θα πρέπει να τοποθετείται με την τάπα της.</p>		

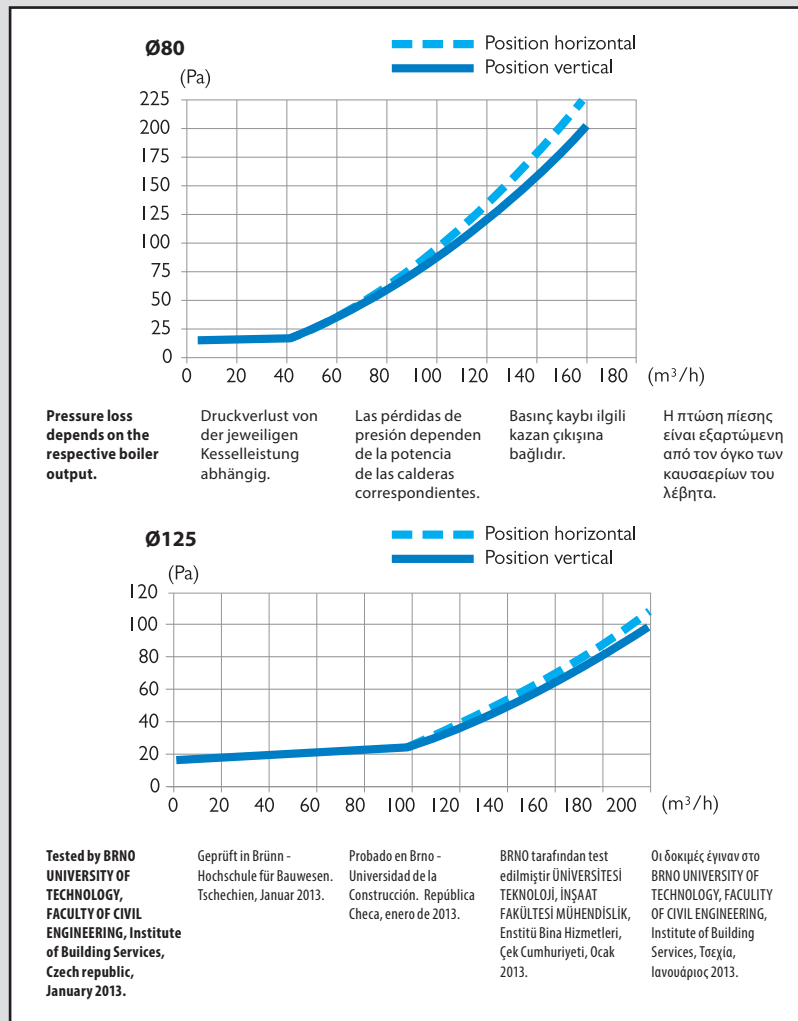
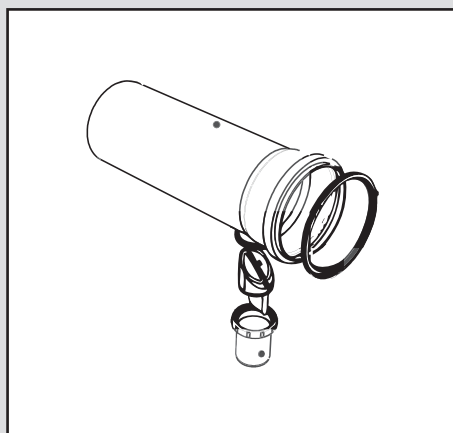

CAS

Δεν κατασκευάσαμε ένα νέο σύστημα καπνοδόχου, το βελτιώσαμε !

# GAS FLUE SYSTEM FOR APPLIANCES CONNECTED TO CASCADE

CAS

ABGASSYSTEM FÜR KASKADE

PPH – black

SISTEMA DE EVACUACIÓN EN CASCADA

PPH – schwarz · PPH – negro

KASKAD'A BAĞLI CİHAZLAR İÇİN GAZ BACA SİSTEMİ

PPH – siyah · PPH – μαύρο

ΣΥΣΤΗΜΑ ΚΑΠΝΟΔΟΧΩΝ ΓΙΑ ΣΥΣΚΕΥΕΣ ΣΕ ΣΥΣΤΟΙΧΙΑ, CASCADE

## Var.1 - Ø80 – 315 mm

with branch • mit Abzweiger • con rama • dal ile • με διακλάδωση 45°, 87° Ø60 – 250 mm

**STARR Collector pipe 45° branch**  
 STARR Kaskadenrohr 45° • STARR Colector 45° • STARR Kollektör borusu 45° branşman • STARR Σωλήνας με διακλάδωση 45°



Ø	Code Código	Kod Κωδ.	a (mm)	b (mm)	c (mm)	d (mm)	i
80/60	PBRK58		81	62	938	75	
100/60	PBRK5X		101	63	937	75	
100/80	PBRK8X		101	63	937	80	
110/60	PBRK51		111	73	927	75	
110/80	PBRK81		111	73	927	80	
110/100	PBRKX1		111	73	927	85	
125/60	PBRK52		127	75	925	75	
125/80	PBRK82		127	75	925	80	
125/100	PBRKX2		127	75	925	85	
125/110	PBRK12		127	75	925	85	
160/60	PBRK56		162	85	915	75	
160/80	PBRK86		162	85	915	80	
160/100	PBRKX6		162	85	915	85	
160/110	PBRK16		162	85	915	85	
160/125	PBRK26		162	85	915	90	
200/60	PBRK50		203	150	850	75	
200/80	PBRK80		203	150	850	80	
200/100	PBRKX0		203	150	850	85	
200/110	PBRK10		203	150	850	85	
200/125	PBRK20		203	150	850	90	
200/160	PBRK60		203	150	850	100	
250/60	PBRK5V		254	260	740	75	
250/80	PBRK8V		254	260	740	80	
250/100	PBRKXV		254	260	740	85	
250/110	PBRK1V		254	260	740	85	
250/125	PBRK2V		254	260	740	90	
250/160	PBRK6V		254	260	740	100	
250/200	PBRK0V		254	260	740	135	
315/60	PBRK53		319	290	710	75	
315/80	PBRK83		319	290	710	80	
315/100	PBRKX3		319	290	710	85	
315/110	PBRK13		319	290	710	85	
315/125	PBRK23		319	290	710	90	
315/160	PBRK63		319	290	710	100	
315/200	PBRK03		319	290	710	135	
315/250	PBRKV3		319	290	710	245	

**STARR Cascade end-piece with siphon**  
 STARR Endstück f. Kaskade m. Siphon • STARR Terminal cascada con sifón • STARR Sifonlu kaskad uç parçası • STARR Τερματικό εξάρτημα offset cascade με σιφόνι

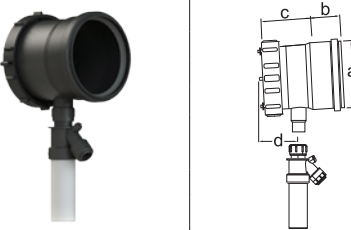

Ø	Code Código	Kod Κωδ.	a (mm)	b (mm)	c (mm)	d (mm)	i
80	PBEKA8		81	63	100	50	
100	PBEKAX		101	63	120	86	
110	PBEKA1		111	73	120	86	
125	PBEKA2		127	75	120	87	
160	PBEKA6		162	85	115	87	
200	PBEKA0		203	150	135	100	
250	PBEKAV		254	260	-	-	
315	PBEKA3		319	290	-	-	

# GAS FLUE SYSTEM FOR APPLIANCES CONNECTED TO CASCADE

CAS

ABGASSYSTEM FÜR KASKADE

PPH – black

SISTEMA DE EVACUACIÓN EN CASCADA

PPH – schwarz · PPH – negro

KASKAD'A BAĞLI CİHAZLAR İÇİN GAZ BACA SİSTEMİ

PPH – siyah · PPH – μαύρο

ΣΥΣΤΗΜΑ ΚΑΠΝΟΔΟΧΩΝ ΓΙΑ ΣΥΣΚΕΥΕΣ ΣΕ ΣΥΣΤΟΙΧΙΑ, CASCADE

## Var.1 - Ø80 – 315 mm

with branch • mit Abzweiger • con rama • dal ile • με διακλάδωση 45°, 87° Ø60 – 250 mm

### STARR Collector pipe 87° branch

STARR Kaskadenrohr 87° • STARR Colector 87° • STARR Kollektör borusu 87° branş • STARR Σωλήνας με διακλάδωση 87°

Ø	Code Código	Kod Κωδ.	a (mm)	b (mm)	c (mm)	d (mm)	i
80/60	PBTE58		81	62	938	65	
100/60	PBTE5X		101	63	937	65	
100/80	PBTE8X		101	63	937	70	
110/60	PBTE51		111	73	927	65	
110/80	PBTE81		111	73	927	70	
110/100	PBTEX1		111	73	927	75	
125/60	PBTE52		127	75	925	65	
125/80	PBTE82		127	75	925	70	
125/100	PBTEX2		127	75	925	75	
125/110	PBTE12		127	75	925	75	
160/60	PBTE56		162	85	915	65	
160/80	PBTE86		162	85	915	70	
160/100	PBTEX6		162	85	915	75	
160/110	PBTE16		162	85	915	75	
160/125	PBTE26		162	85	915	80	
200/60	PBTE50		203	150	850	65	
200/80	PBTE80		203	150	850	70	
200/100	PBTEX0		203	150	850	75	
200/110	PBTE10		203	150	850	75	
200/125	PBTE20		203	150	850	80	
200/160	PBTE60		203	150	850	90	
250/60	PBTE5V		254	260	740	65	
250/80	PBTE8V		254	260	740	70	
250/100	PBTEXV		254	260	740	75	
250/110	PBTE1V		254	260	740	75	
250/125	PBTE2V		254	260	740	80	
250/160	PBTE6V		254	260	740	90	
250/200	PBTE0V		254	260	740	125	
315/60	PBTE53		319	290	710	65	
315/80	PBTE83		319	290	710	70	
315/100	PBTEX3		319	290	710	75	
315/110	PBTE13		319	290	710	75	
315/125	PBTE23		319	290	710	80	
315/160	PBTE63		319	290	710	90	
315/200	PBTE03		319	290	710	125	
315/250	PBTEV3		319	290	710	235	

### STARR Collector pipe 87° branch with BV

STARR Kaskadenrohr 87° mit Abgasklappe • STARR Colector 87° con válv. antiretorno • STARR Kollektör borusu BV ile 87° branşman • STARR Σωλήνας με διακλάδωση 87° και BV (αντεπίστροφη βαλβίδα)

Ø	Code Código	Kod Κωδ.	a (mm)	b (mm)	c (mm)	d (mm)	i
100/80	PBTK8X		101	63	937	110	
110/80	PBTK81		111	73	927	110	
125/80	PBTK82		127	75	925	110	
160/80	PBTK86		162	85	915	110	
200/80	PBTK80		203	150	850	110	
250/80	PBTK8V		254	260	740	110	
315/80	PBTK83		319	290	710	110	
160/125	PBTK26		162	85	915	110	
200/125	PBTK20		203	150	850	110	
250/125	PBTK2V		254	260	740	110	
315/125	PBTK23		319	290	710	110	

CAS

# GAS FLUE SYSTEM FOR APPLIANCES CONNECTED TO CASCADE

CAS

ABGASSYSTEM FÜR KASKADE

PPH – black

SISTEMA DE EVACUACIÓN EN CASCADA

PPH – schwarz · PPH – negro

KASKAD'A BAĞLI CİHAZLAR İÇİN GAZ BACA SİSTEMİ

PPH – siyah · PPH – μαύρο

ΣΥΣΤΗΜΑ ΚΑΠΝΟΔΟΧΩΝ ΓΙΑ ΣΥΣΚΕΥΕΣ ΣΕ ΣΥΣΤΟΙΧΙΑ, CASCADE

## Var.1 - Ø80 – 315 mm

with branch • mit Abzweiger • con rama • dal ile • με διακλάδωση 45°, 87° Ø60 – 250 mm

**STARR Cascade end-piece with BV**  
 STARR Endstück f. Kaskade m. Abgasklappe • STARR Terminal cascada con válv. antiretorno • BV ile STARR Kaskad uç parçası • STARR Τερματικό εξάρτημα axial cascade με BV (αντεπίστροφη βαλβίδα)

Ø	Code Código	Kod Κωδ.	a (mm)	b (mm)	c (mm)	d (mm)	i
80/80	PBEK08		81	62	266	130	
100/80	PBEK0X		101	63	280	160	
110/80	PBEK01		111	73	280	160	
125/80	PBEK02		127	75	330	150	
160/80	PBEK06		162	85	320	180	
200/80	PBEK00		203	150	370	230	
250/80	PBEK0V		254	260	-	-	
315/80	PBEK03		319	290	-	-	
160/125	PBEK26		162	85	320	180	
200/125	PBEK20		203	150	370	230	
250/125	PBEK2V		254	260	-	-	
315/125	PBEK23		319	290	-	-	

**STARR Boiler adapter-Tee with test plug (reduced)**  
 STARR Umlenk-T m. MÖ als KA (reduziert) • STARR Te-Adapt. cald. con tm/muestras (reducido) • STARR Kazan adaptörü-Tee test fişli (azaltılmış) • STARR Ταφ με θυρίδα επιθεώρησης και σημείο μέτρησης (συστολικό)

Ø	Code Código	Kod Κωδ.	a (mm)	b (mm)	c (mm)	d (mm)	i
80	PBKT01		60	68	245	161	
110	PBKT051		60	63	225	158	
110	PBKT08		80	63	225	158	
125	PBKTR52		60	75	315	225	
125	PBKT06		80	75	315	225	
125	PBKT13		110	75	315	225	
160	PBKT61		80	85	360	215	
160	PBKT18		110	85	360	215	
160	PBKT19		125	85	360	215	
200	PBKTR80		80	150	470	280	
200	PBKT30		110	150	470	280	
200	PBKT35		125	150	470	280	
200	PBKT27		160	150	470	280	
250	PBKTR1V		110	190	300	215	
250	PBKTR2V		125	190	334	242	
250	PBKT2V		160	190	420	310	
250	PBKTV4		200	190	460	330	
315	PBKTR13		110	190	315	230	
315	PBKTR23		125	190	350	260	
315	PBKTR63		160	190	435	325	
315	PBKT64		200	190	475	395	
315	PBKT66		250	190	495	355	

CAS

**STARR Inspection-Tee with drain**  
 STARR Revisions-T m. Ablauf • STARR Te-Inspección con desc./cond. • STARR Drenajlı Muayene T'si • STARR Ταφ με θυρίδα επιθεώρησης και αποστράγγιση

Ø	Code Código	Kod Κωδ.	a (mm)	b (mm)	c (mm)	d (mm)	i
80	PBRTA8		81	62	270	162	
100	PBRTAX		101	63	187	155	
110	PBRTA1		111	73	237	174	
125	PBRTA2		127	75	325	180	
160	PBRTA6		162	85	300	205	
200	PBRTA0		203	150	350	240	
250	PBRTAV		254	260			
315	PBRTA3		319	290			

# GAS FLUE SYSTEM FOR APPLIANCES CONNECTED TO CASCADE

CAS

PPH – black

PPH – schwarz · PPH – negro

PPH – siyah · PPH – μαύρο

ABGASSYSTEM FÜR KASKADE

SISTEMA DE EVACUACIÓN EN CASCADA

KASKAD'A BAĞLI CİHAZLAR İÇİN GAZ BACA SİSTEMİ

ΣΥΣΤΗΜΑ ΚΑΠΝΟΔΟΧΩΝ ΓΙΑ ΣΥΣΚΕΥΕΣ ΣΕ ΣΥΣΤΟΙΧΙΑ, CASCADE

## Var.1 - Ø80 – 315 mm

with branch · mit Abzweiger · con rama · dal ile · με διακλάδωση 45°, 87° Ø60 – 250 mm

ZUB Siphon (for pressure M1)										
ZUB Siphon (für Überdruck M1) · ZUB Sifón (sobrepresión M1) · ZUB Sifon (M1 basıncı için) · ZUB Σιφόνι (για υπερπίεση M1)										
		transluent · translúcido · yarı saydam · Διαφανές	Ø	Code Código	Kod Κωδ.	a (mm)	b (mm)	c (mm)	d (mm)	
			32 mm	ZUOS32		45	25	210	100	
			-	-		-	-	-	-	

ZUB Backflow valve components (BV)										
ZUB Komponenten der Abgasklappe · ZUB Componentes de la válvula antirretorno · ZUB Geri akış valfi bileşenleri (BV) · ZUB Αντεπίστροφη βαλβίδα (BV)										
			Ø	Code Código	Kod Κωδ.	a (mm)	b (mm)	c (mm)	d (mm)	
			AK NW80	PPSK08		-	-	-	-	
			AK NW125	PPSK02		-	-	-	-	
			Siphon	PPSS00		-	-	-	-	Siphon · Sifón · Sifon · Σιφόνι
			Plug	PPKS00		-	-	-	-	Stopfen · Tapón · Tak · Τάπα

ZUB Backflow protection										
ZUB Rückstromsicherung · ZUB Tramo c. válvula antirretorno · ZUB Geri akış koruması · ZUB Αντεπίστροφη βαλβίδα Multi BV										
			Ø	Code Código	Kod Κωδ.	a (mm)	b (mm)	c (mm)	d (mm)	
			110	PBK121		-	-	-	-	<b>With backflow valve Ø125 with siphon and plug</b>  Mit Abgasklappe Ø125 Con válvula antirretorno Ø125 Sifonlu ve tapalı geri akış valfi Ø125 Αντεπίστροφη βαλβίδα Ø125 με σιφόνι & τάπα
			-	-		-	-	-	-	
			-	-		-	-	-	-	
			-	-		-	-	-	-	
			-	-		-	-	-	-	
			-	-		-	-	-	-	
			-	-		-	-	-	-	
			-	-		-	-	-	-	

The additional items required for mounting the CAS (variant 1) are included in the STARR, FLEX and ZUB systems.

Die zusätzlichen für die Montage des CAS (Variante 1) notwendigen Artikel sind in den Systemen STARR, FLEX und ZUB enthalten.

Los componentes adicionales necesarios para completar el montaje del sistema CAS (variante 1) están disponibles en los sistemas STARR, FLEX y ZUB.

Ek öğeler montaj için gerekli CAS (varyant 1) dahil edilmmiştir STARR, FLEX ve ZUB, da sistemler.

Τα πρόσθετα εξαρτήματα που απαιτούνται για την τοποθέτηση του συστήματος CAS (παραλλαγή 1) περιέχονται στα συστήματα STARR, FLEX, ή και ZUB.

CAS

# CONCENTRIC GAS FLUE SYSTEM FOR APPLIANCES CONNECTED TO CASCADE **CAS**

KONZENTRISCHES ABGASSYSTEM FÜR KASKADE  
 SISTEMA DE EVACUACIÓN EN CASCADA CONCÉNTRICO  
 KONSANTRİK KASKAD'A BAĞLI CİHAZLAR İÇİN GAZ BACA SİSTEMİ  
 ΣΥΣΤΗΜΑ ΚΑΠΝΟΔΟΧΩΝ ΓΙΑ ΣΥΣΚΕΥΕΣ ΣΕ ΣΥΣΤΟΙΧΙΑ, CASCADE

**PPH/stainless steel – white powder coated**

PPH/Edelstahl weiss pulverbeschichtet

PPH/Acero inoxidable en epoxy blanco

PPH/paslanmaz çelik - beyaz toz boyalı

PPH/ανοξειδωτος χάλυβας – λευκή ηλεκτροστατική βαφή

## Var.2 - Ø110/160 – 200/300 mm

with branch • mit Abzweiger • con rama • dal ile • με διακλάωση 87° Ø60/100, 80/125 mm

AXIAL	
1	LPRLA1
2	LPTL51
3	LPTL12
4	ZUOS32
5	LPRL05

### Concentric cascade type AXIAL with backflow valves.

Kaskade konzentrisch Type AXIAL mit Abgasklappen.

Cascada concéntrica tipo AXIAL con válvulas antiretorno.

Geri akış valfli eşmerkezli kaskad tip AXIAL.

Ομοκεντρικό σύστημα συστοιχίας τύπου AXIAL με αντεπίστροφες βαλβίδες (BV).

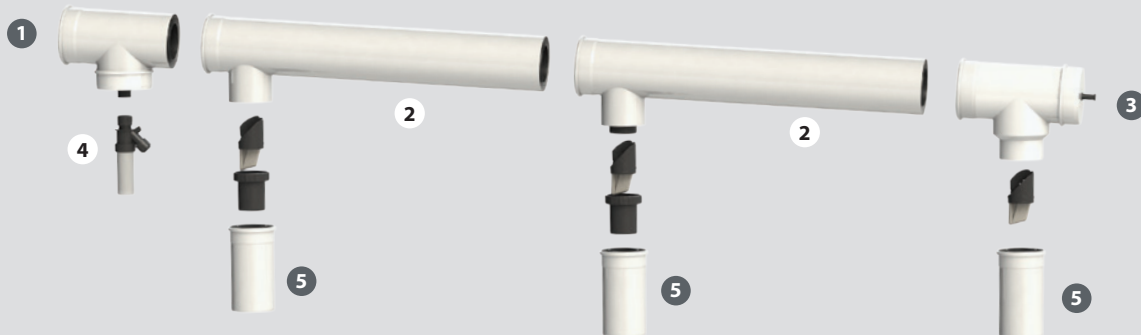

OFFSET	
1	LPRLA1
2	LPTKL81
3	LPTL12
4	ZUOS32
5	LPRL05

### Concentric cascade type OFFSET without backflow valves.

Kaskade konzentrisch Type OFFSET ohne Abgasklappen.

Cascada concéntrica tipo OFFSET sin válvulas antiretorno.

Konsantrik kaskad tip OFFSET geri akış valfsiz.

Ομοκεντρικό σύστημα συστοιχίας τύπου OFFSET χωρίς αντεπίστροφες βαλβίδες (BV).

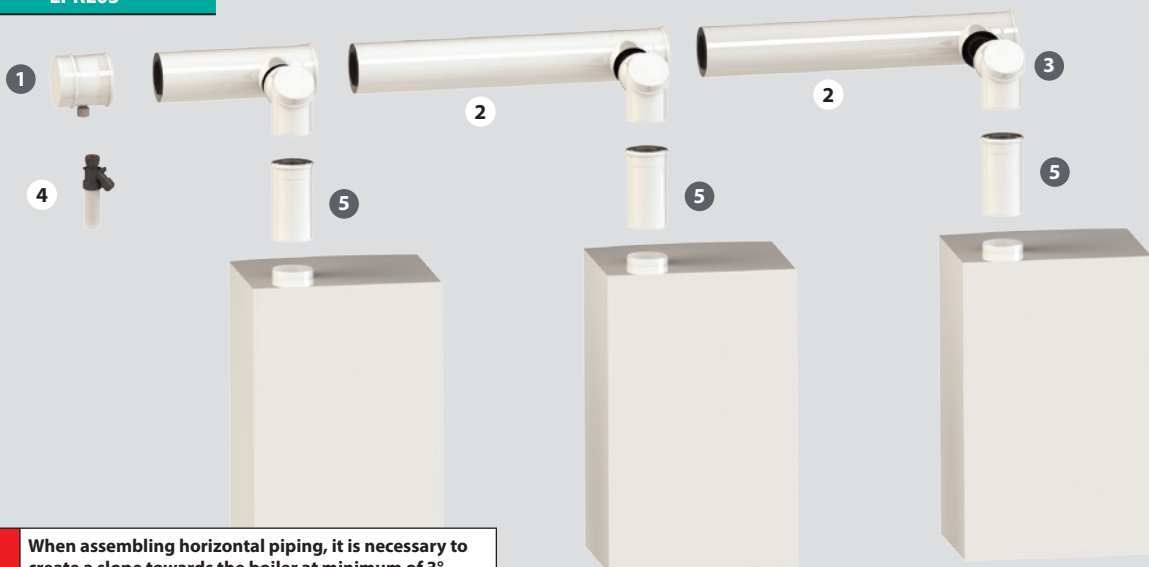

**When assembling horizontal piping, it is necessary to create a slope towards the boiler at minimum of 3°.**

Gefälle schaffen waagerechte Verbindungsleitung muss zum Kessel immer ein Gefälle von mindestens 3° haben.

Al montar las tuberías horizontales, es necesario crear una pendiente hacia la caldera de un mínimo de 3°.

Yatay boru tesisatını monte ederken, kazana doğru en az 3°'lik bir eğim oluşturmak gerekir.

Κατά την εγκατάσταση οριζόντιων σωληνώσεων, πρέπει να υπάρχει κλίση προς τον λέβητα τουλάχιστον 3°.

CAS

# CONCENTRIC GAS FLUE SYSTEM FOR APPLIANCES CONNECTED TO CASCADE **CAS**

KONZENTRISCHES ABGASSYSTEM FÜR KASKADE

SISTEMA DE EVACUACIÓN EN CASCADA CONCÉNTRICO

KONSANTRİK KASKAD'A BAĞLI CİHAZLAR İÇİN GAZ BACA SİSTEMİ

ΣΥΣΤΗΜΑ ΚΑΠΝΟΔΟΧΩΝ ΓΙΑ ΣΥΣΚΕΥΕΣ ΣΕ ΣΥΣΤΟΙΧΙΑ, CASCADE

**PPH/stainless steel – white powder coated**

PPH/Edelstahl weiss pulverbeschichtet

PPH/Acero inoxidable en epoxi blanco

PPH/paslanmaz çelik - beyaz toz boyalı

PPH/ανοξειδωτος χάλυβας – λευκή ηλεκτροστατική βαφή

## Var.2 - Ø110/160 – 200/300 mm

with branch • mit Abzweiger • con rama • dal ile • με διακλάδωση 87° Ø60/100, 80/125 mm

**LIL Pipe with socket**  
LIL Rohr m. Muffe • LIL Tubo M/H • LIL Söketli boru • LIL Σωλήνα με υποδοχή (κεφάλι)

	Ø	Code Código	Kod Κωδ.	a (mm)	b (mm)	c (mm)	d (mm)	i
250 mm	60/100	LPRL05		104	52	198	-	
	80/125	LPRL08		130	52	198	-	
	100/150	LPRL0X		153	52	198	-	
	110/160	LPRL01		163	52	198	-	
	125/180	LPRL02		182	62	188	-	
	160/225	LPRL06		227	67	183	-	
500 mm	200/300	LPRL00		302	67	183	-	
	60/100	LPRL55		104	52	448	-	
	80/125	LPRL58		130	52	448	-	
	100/150	LPRL5X		153	52	448	-	
	110/160	LPRL51		163	52	448	-	
	125/180	LPRL52		182	62	438	-	
1000 mm	160/225	LPRL56		227	67	433	-	
	200/300	LPRL50		302	67	433	-	
	60/100	LPRL15		104	52	948	-	
	80/125	LPRL18		130	52	948	-	
	100/150	LPRL1X		153	52	948	-	
	110/160	LPRL11		163	52	948	-	
	125/180	LPRL12		182	62	938	-	
	160/225	LPRL16		227	67	933	-	
	200/300	LPRL10		302	67	933	-	

**LIL Collector pipe 87° branch w/o BV**  
LIL Kaskadenrohr 87° ohne Abgasklappe • LIL Colector 87° sin VA • LIL Kollektör borusu BV'siz 87° branşman • LIL Σωλήνας με διακλάδωση 87°

	Ø	Code Código	Kod Κωδ.	a (mm)	b (mm)	c (mm)	d (mm)	i
1000 mm	* branch 60/100	110/160	LPTEL51	110	52	948	85	
		125/180	LPTEL52	125	55	938	87	
		160/225	LPTEL56	160	67	933	92	
	* branch 80/125	200/300	LPTEL50	200	67	933	110	
		110/160	LPTEL81	110	52	948	125	
		125/180	LPTEL82	125	62	938	127	
	* branch 110/160	160/225	LPTEL86	160	67	933	132	
		200/300	LPTEL80	200	67	933	150	
		125/180	LPTEL12	125	55	938	118	
	160/225	LPTEL16	160	67	933	123		
	200/300	LPTEL10	200	67	933	140		
	-	-	-	-	-	-	-	

**LIL Collector pipe 87° branch with BV**  
LIL Kaskadenrohr 87° mit Abgasklappe • LIL Colector 87° con VA • LIL Kollektör borusu BV ile 87° branşman • LIL Σωλήνας με διακλάδωση 87° και BV (αντεπίστροφη βαλβίδα)

	Ø	Code Código	Kod Κωδ.	a (mm)	b (mm)	c (mm)	d (mm)	i
1000 mm	* branch 80/125	-	-	-	-	-	-	
		-	-	-	-	-	-	
		110/160	LPTKL81	110	52	948	125	
	* branch 125/180	125/180	LPTKL82	125	62	938	127	
		160/225	LPTKL86	160	67	933	132	
		200/300	LPTKL80	200	67	933	150	
		160/225	LPTKL26	160	67	933	132	
		200/300	LPTKL20	200	67	933	150	
		-	-	-	-	-	-	
		-	-	-	-	-	-	

\* branch • Abzweiger • rama • branşman • διακλάδωση



# CONCENTRIC GAS FLUE SYSTEM FOR APPLIANCES CONNECTED TO CASCADE **CAS**

KONZENTRISCHES ABGASSYSTEM FÜR KASKADE  
SISTEMA DE EVACUACIÓN EN CASCADA CONCÉNTRICO  
KONSANTRİK KASKAD'A BAĞLI CİHAZLAR İÇİN GAZ BACA SİSTEMİ  
ΣΥΣΤΗΜΑ ΚΑΠΝΟΔΟΧΩΝ ΓΙΑ ΣΥΣΚΕΥΕΣ ΣΕ ΣΥΣΤΟΙΧΙΑ, CASCADE

**PPH/stainless steel – white powder coated**

PPH/Edelstahl weiss pulverbeschichtet

PPH/Acero inoxidable en epoxi blanco

PPH/paslanmaz çelik - beyaz toz boyalı

PPH/ανοξειδωτος χάλυβας – λευκή ηλεκτροστατική βαφή

## Var.2 - Ø110/160 – 200/300 mm

with branch • mit Abzweiger • con rama • dal ile • με διακλάδωση 87° Ø60/100, 80/125 mm

### LIL Boiler Adapter-Tee with test plug (reduced)

LIL Umlenk-T m. MÖ (reduziert) • LIL Te-Adapt. cald. con tm./muestras (reducida) • LIL Kazan Adaptörü-Tee test tapalı (azaltılmış) • LIL Ταφ με θυρίδα επιθεώρησης και σημείο μέτρησης (συστολικό)

	Ø	Code Código	Kod Κωδ.	a (mm)	b (mm)	c (mm)	d (mm)	i
* branch 80/125	110 / 160	LPTL12		80	125	210	375	
	125 / 180	LPTL22		80	125	225	382	
	160 / 225	LPTL60		80	125	255	427	
	200 / 300	LPTL00		80	125	305	502	
* branch 110/160	125 / 180	LPTL24		110	160	225	382	
	160 / 225	LPTL62		110	160	255	427	
	200 / 300	LPTL02		110	160	305	502	
-	-	-	-	-	-	-	-	

\* branch • Abzweiger • rama • branşman • διακλάδωση

### LIL Cascade end-piece w. test plug and BV (reduced)

LIL Endstück m. MÖ u. AK (reduziert) • LIL Terminal cascada c. tm./muestras y VA (reducido) • LIL Cascade uç parçası, test tapası ve BV (azaltılmış) • LIL Ταφ με θυρίδα επιθεώρησης με σημείο μέτρησης και BV (συστολικό)

	Ø	Code Código	Kod Κωδ.	a (mm)	b (mm)	c (mm)	d (mm)	i
* branch 80/125	110/160	LPEKL81		80	125	210	375	
	125/180	LPEKL82		80	125	225	382	
	160/225	LPEKL86		80	125	255	427	
	200/300	LPEKL80		80	125	305	502	
* branch 125/180	160/225	LPEKL26		110	160	255	427	
	200/300	LPEKL20		110	160	305	502	
	-	-	-	-	-	-	-	

\* branch • Abzweiger • rama • branşman • διακλάδωση

### LIL Inspection elbow 87°

LIL Revisionsbogen 87° • LIL Codo inspección 87° • LIL Dürsek 87° w. test tapası • LIL Καμπύλη 87° με θυρίδα επιθεώρησης

	Ø	Code Código	Kod Κωδ.	a (mm)	b (mm)	c (mm)	d (mm)	i
* branch 80/125	60/100	LPRBL5		104	52	125	95	
	80/125	LPRBL8		130	52	130	110	
	110/160	LPRBL1		163	52	140	130	
-	-	-	-	-	-	-	-	

### LIL Drain-Tee horizontal

LIL Ablauf-T horizontal • LIL Te-Desc./condens. horz. • LIL Drain-Tee yatay • LIL Ταφ με θυρίδα επιθεώρησης και αποστράγγιση

	Ø	Code Código	Kod Κωδ.	a (mm)	b (mm)	c (mm)	d (mm)	i
* branch 80/125	110/160	LPRLA1		163	52	278	220	
	125/180	LPRLA2		182	62	320	200	
	160/225	LPRLA6		227	67	360	220	
	200/300	LPRLA0		302	67	435	250	

### LIL Cascade end-piece with condensate trap

LIL Kaskaden-Endstück mit Kondensatfalle • LIL Terminal cascada con desc./condens. • Yoğuşma suyu tutuculu LIL Cascade uç parçası • LIL Τερματικό εξάρτημα cascade με αποστράγγιση

	Ø	Code Código	Kod Κωδ.	a (mm)	b (mm)	c (mm)	d (mm)	i
* branch 80/125	110/160	LPEKFL1		163	52	105	80	
	125/180	LPEKFL2		182	80	185	80	
	160/225	LPEKFL6		227	80	185	80	
	200/300	LPEKFL0		302	80	185	80	

CAS



ZUBEHÖR  
ACCESORIOS  
AKSESUARLAR  
ΕΞΑΡΤΗΜΑΤΑ

## Siphons

Siphons  
Sifones  
Sifonlar  
Σιφόνια



## Neutralization boxes

Neutraboxen  
Box-Neutralización  
Nötralizasyon kutuları  
Κουτιά εξουδετέρωσης



## Intake protective baskets

Schutzkörbe  
Protecciones  
Giriş koruyucu sepetleri  
Προστατευτικά απόρριψης



## Ventilation grills

Lüftungsgitter  
Remate ventilación  
Havalandırma izgaraları  
Γρίλιες αερισμού



## Inspection doors

Revisionstüren  
Puertas de inspección  
Muayene kapıları  
Θυρίδες επιθεώρησης



## Seals

Dichtungen  
Juntas  
Sızdırmazlık halkaları  
Δακτύλιοι στεγανοποίησης



## Greases



Silikonfett  
Lubricantes silicona  
Bağlantı yağlayıcıları  
Λιπαντικά σύνδεσης





## ACCESSORIES

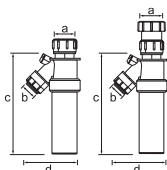

ZUB

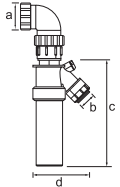
ZUBEHÖR  
ACCESORIOS  
AKSESUARLAR  
ΕΞΑΡΤΗΜΑΤΑ



<b>ZUB Siphon (for pressure M1)</b> ZUB Siphon (für Überdruck M1) • ZUB Sifón (sobrepresión M1) • ZUB Sifon (M1 basıncı için) • ZUB Σιφόνι (για υπερπίεση M1)											
		translucent - translúcido - yarı saydam - Διαφανές	Ø	Code Código	Kod Κωδ.	a (mm)	b (mm)	c (mm)	d (mm)	  	
			32 mm	ZUOS32		45	25	210	100		
			40 mm	ZUOS40		60	25	225	100		



<b>ZUB Siphon 90° (for high pressure)</b> ZUB Siphon 90° (für Überdruck) • ZUB Sifón 90° (sobrepresión) • ZUB Sifon 90° (yüksek basınç için) • ZUB Σιφόνι 90° (για υπερπίεση M1)											
		translucent translúcido yarı saydam Διαφανές	Ø	Code Código	Kod Κωδ.	a (mm)	b (mm)	c (mm)	d (mm)		
			* outlet 32 mm with elbow 90°	ZUOS93		45	25	210	100		
			* outlet 40 mm with elbow 90°	ZUOS94		60	25	225	100		

\* outlet with elbow 90° • Abgang mit Bogen 90° • Salida con codo 90° • 90° dirseklı çıkış • σύνδεση 90°

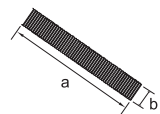
<b>ZUB Condensate level sensor for siphon</b> ZUB Kondensatstandsensor für Siphon • ZUB Sensor nivel de condensado para sifón • ZUB Sifon için yoğuşma suyu seviye sensörü • ZUB Αισθητήρας στάθμης συμπυκνωμάτων για σιφόνι													
		-	Ø	Code Código	Kod Κωδ.	a (mm)	b (mm)	c (mm)	d (mm)	e (mm)			
			-	ZUOSE1		-	-	-	-	-		-	-
			-	-		-	-	-	-	-		-	-

\* outlet • Abgang • Salida • çıkış • σύνδεση

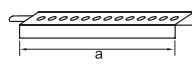
<b>ZUB Condensate outlet hose</b> ZUB Kondensat-Flexrohr • ZUB Manguera para condensados • ZUB Yoğuşma suyu çıkış hortumu • ZUB Εύκαμπτος σωλήνας συμπυκνωμάτων												
		-	Ø	Code Código	Kod Κωδ.	a (mm)	b (mm)	c (mm)	d (mm)	e (mm)		
			25	ZUWK01		1 000	25	-	-	-		-
			25	ZUWK50		50 000	25	-	-	-		-

<b>ZUB Console to the heel knee</b> ZUB Auflageschiene • ZUB Tablilla de apoyo • ZUB Topuk dizine konsol • ZUB Αγκύρωση για καμπύλη στερέωσης													
		-	Ø	Code Código	Kod Κωδ.	a (mm)	b (mm)	c (mm)	d (mm)	e (mm)			
			-	ZUAS01		390	-	-	-	-		-	Aluminium Aluminium • Aluminio Alüminyum • Αλουμίνιο
			-	ZUAS00		390	-	-	-	-		-	Stainless steel Edelstahl • Acero inoxidable • Paslanmaz çelik • Ανοξείδωτος χάλυβας

ZUB



Δεν κατασκευάσαμε ένα νέο σύστημα καπνοδόχου, το βελτιώσαμε !

## ACCESSORIES

ZUB

ZUBEHÖR  
ACCESORIOS  
AKSESUARLAR  
ΕΞΑΡΤΗΜΑΤΑ

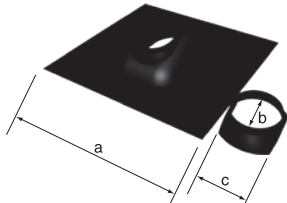
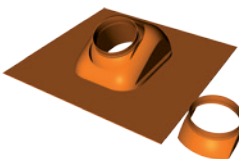
**ZUB Universal roof flashing 5° - 55° UNI (complete)**  
ZUB Universal-Dachpfanne 5° - 55° UNI (komplett) • ZUB Salida techo univ. 5° - 55° UNI • ZUB Üniversal çatı flaşörü 5° - 55° Uni (komple) • ZUB Διάβαση στέγης καπνοδόχου 5° - 55° UNI (πλήρες)

	Ø	Code Código	Kod Κωδ.	a (mm)	b (mm)	c (mm)	i
	5° - 25°	60/100 - 80/125	ZUD02S	500	138	132	<b>Plastic - black</b> Kunststoff - schwarz Plástico negro Plastik - siyah Πλαστικό - μαύρο
		110/160	ZUD06S	700	165	180	
		60/100 - 80/125	ZUD02T	500	138	132	<b>Plastic - terracotta</b> Kunststoff - terracotta Plástico terracota Plastik - terracotta Πλαστικό - τερακότα
		110/160	ZUD06T	700	165	180	
	25° - 45°	60/100 - 80/125	ZUD22S	500	138	132	<b>Plastic - black</b> Kunststoff - schwarz Plástico negro Plastik - siyah Πλαστικό - μαύρο
		110/160	ZUD26S	700	165	180	
		60/100 - 80/125	ZUD22T	500	138	132	<b>Plastic - terracotta</b> Kunststoff - terracotta Plástico terracota Plastik - terracotta Πλαστικό - τερακότα
		110/160	ZUD26T	700	165	180	
	35° - 55°	60/100 - 80/125	ZUD32S	500	138	132	<b>Plastic - black</b> Kunststoff - schwarz Plástico negro Plastik - siyah Πλαστικό - μαύρο
		110/160	ZUD36S	700	165	180	
		60/100 - 80/125	ZUD32T	500	138	132	<b>Plastic - terracotta</b> Kunststoff - terracotta Plástico terracota Plastik - terracotta Πλαστικό - τερακότα
		110/160	ZUD36T	700	165	180	

**ZUB Roof flashing**  
ZUB Dachpfanne • ZUB Salida techo • ZUB Çatı flashingleri • ZUB Διάβαση στέγης καπνοδόχου

	Ø	Code Código	Kod Κωδ.	a (mm)	b (mm)	i
	60/100 - 80/125	ALPP35	-	-	<b>Plastic - black</b> Kunststoff - schwarz • Plástico negro • Plastik - siyah • Πλαστικό - μαύρο χρώμα	
	-	-	-	-		
	-	-	-	-		

**FLEX Pull through head**  
FLEX Einzugshilfe f. Flexrohre • FLEX Cabezal de arrastre pr. FLEX • FLEX Başlık boyunca çekin • FLEX Εργαλείο τοποθέτησης εύκαμπτου

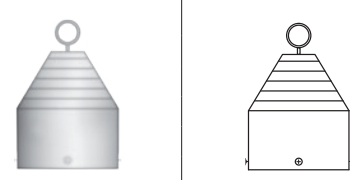





	Ø	Code Código	Kod Κωδ.	a (mm)	b (mm)	c (mm)	d (mm)	i
	60	ZUEZH5	-	-	-	-	<b>Rope is not supplied</b> Kopfteil ohne Seil Cabezal sin cuerda Halat tedarik edilmez Δεν περιλαμβάνεται σχοινί	
	80	ZUEZH8	-	-	-	-		
	110	ZUEZH1	-	-	-	-		
	125	ZUEZH2	-	-	-	-		
	160	ZUEZH6	-	-	-	-		
	200	ZUEZH0	-	-	-	-		

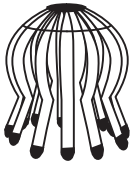

ZUB



## ACCESSORIES

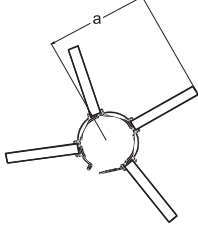

ZUB

ZUBEHÖR  
ACCESORIOS  
AKSESUARLAR  
ΕΞΑΡΤΗΜΑΤΑ

<b>ZUB Intake protective basket</b> ZUB Schutzkorb (Zuluft) • ZUB Protectores • ZUB Emme koruyucu sepet • ZUB Προστατευτικό απόρριψης									
		Ø	Code Código	Kod Κωδ.	a (mm)	b (mm)	c (mm)	d (mm)	
		80-110	ZUAV52	-	-	-	-	-	
-	-	-	-	-	-	-	-	-	
-	-	-	-	-	-	-	-	-	
-	-	-	-	-	-	-	-	-	
-	-	-	-	-	-	-	-	-	
		80	ALIL08	-	-	-	-	-	<b>Stainless steel</b> Edelstahl Acero inoxidable Paslanmaz çelik Ανοξείδωτος χάλυβας
		-	-	-	-	-	-	-	
-	-	-	-	-	-	-	-	-	
-	-	-	-	-	-	-	-	-	
-	-	-	-	-	-	-	-	-	
		80	ALIP08	-	-	-	-	-	<b>Plastic</b> Kunststoff Plástico Plastik Πλαστικό
		-	-	-	-	-	-	-	
-	-	-	-	-	-	-	-	-	
-	-	-	-	-	-	-	-	-	
-	-	-	-	-	-	-	-	-	



<b>ZUB Universal spacer sleeve</b> ZUB Abstandshalter • ZUB Centrador universal • ZUB Üniversal ara parça kovani • ZUB Αποστάτης									
		Ø	Code Código	Kod Κωδ.	a (mm)	b			
		60	PPFR05	260	3	<b>Values in column "b" indicate the number of segments of the spacer sleeve for relevant</b>  In der Spalte b ist Segmentanzahl des Abstandhalter aufgelistet Los valores en la columna b indican los segmentos de espacio entre los centradores "b" sütunundaki değerler, ara parçayı tamamlamak için laminasyon sayısını gösterir. Οι τιμές στη στήλη "b" υποδεικνύουν τον αριθμό των ελασμάτων για την ολοκλήρωση του αποστάτη			
80	PPFR08	270	4						
100	PPFR01	285	5						
110									
125	PPFR02	292	6						
160	PPFR06	310	7						
200	PPFR0X	330	9						
250	PPFR0V	355	11						
315	PPFR03	387	15						
80	PPFRN8	270	1	<b>1 piece of sleeve</b> 1 Stück • 1 Ärmel • 1 braço • 1 ara parçası • 1 αποστάτης					



<b>ZUB Grease</b> ZUB Silikonfett • ZUB Lubricante silicona • ZUB Gres • ZUB Λιπαντικό συνδέσεων										
		Ø	Code Código	Kod Κωδ.	a (mm)	b (mm)	c (mm)	d (mm)	e (mm)	
		50 g	ZUSF05	-	-	-	-	-	-	
-	-	-	-	-	-	-	-	-	-	
-	-	-	-	-	-	-	-	-	-	
250 g	ZUSF25	-	-	-	-	-	-	-	-	
-	-	-	-	-	-	-	-	-	-	

<b>ZUB Measuring plug</b> ZUB Messstopfen • ZUB Tapón toma muestras • ZUB Ölçüm fişi • ZUB Τάπα για σημείο μέτρησης αέρα καύσης										
		Ø	Code Código	Kod Κωδ.	a (mm)	b (mm)	c (mm)	d (mm)	e (mm)	
		Viton < 160°	ZUSTV0	15	20	15	10	-		
EPDM < 120°	ZUSTE0	15	20	15	10	-				

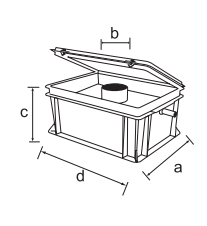
ZUB

ZUBEHÖR  
ACCESORIOS  
AKSESUARLAR  
ΕΞΑΡΤΗΜΑΤΑ



ZUB Neutralization box with accessories									
ZUB Neutralisationsbox m. Füllung • ZUB Box-Neutralización con accesorios • Aksesuarları ile birlikte ZUB nötralizasyon kutusu									
• ZUB Κουτί εξουδετέρωσης όξινων συμπτυκνωμάτων (πλήρες)									
			Code Kod Código Κωδ.	a (mm)	b (mm)	c (mm)	d (mm)	e (mm)	
		Up to bis 120kW/h einsetzbar hasta 120kW/h kadar 120kW/h Έως 120 kW/h	ZUNF12	200	-	185	300	-	<b>gray</b> grau gris Gri Γκρι χρώμα  
		Up to bis 350kW/h einsetzbar hasta 350kW/h kadar 350kW/h Έως 350 kW/h	ZUNF35	300	90	240	400	-	
		Up to bis 1500kW/h einsetzbar hasta 1500kW/h kadar 1500kW/h Έως 1500 kW/h	ZUNF15	400	90	240	600	-	

ZUB Neutralization box filling									
ZUB Nachfüllung für N-Box • ZUB Complementos para Box-Neutralización • ZUB nötralizasyon kutusu dolumu • ZUB Γόμωση κουτιού εξουδετέρωσης									
			Code Kod Código Κωδ.	a (mm)	b (mm)	c (mm)	d (mm)		
		5 kg 5 κιλό	ZUFM12	-	-	-	-	-	<b>Calcite</b> • Marmorsplit • Granulado de cal • Kalsit • Ασβεστίτης <b>for</b> • für • para • için • για: ZUNF12
		10 kg 10 κιλό	ZUFM35	-	-	-	-	-	<b>Calcite</b> • Marmorsplit • Granulado de cal • Kalsit • Ασβεστίτης <b>for</b> • für • para • için • για: ZUNF35
		25 kg 25 κιλό	ZUFM15	-	-	-	-	-	<b>Calcite</b> • Marmorsplit • Granulado de cal • Kalsit • Ασβεστίτης <b>for</b> • für • para • için • για: ZUNF15
		0,31 kg 0,31 κιλό	ZUFK12	-	-	-	-	-	<b>Active carbon</b> • Aktiv-Kohle • Carbón activo • Aktif karbon • Ενεργός άνθρακας <b>for</b> • für • para • için • για: ZUNF12
		0,54 kg 0,54 κιλό	ZUFK35	-	-	-	-	-	<b>Active carbon</b> • Aktiv-Kohle • Carbón activo • Aktif karbon • Ενεργός άνθρακας <b>for</b> • für • para • için • για: ZUNF35
		0,88 kg 0,88 κιλό	ZUFK15	-	-	-	-	-	<b>Active carbon</b> • Aktiv-Kohle • Carbón activo • Aktif karbon • Ενεργός άνθρακας <b>for</b> • für • para • için • για: ZUNF15
		25 pcs • Stk. • uds • adet • τεμ	ZUF500	-	-	-	-	-	<b>pH measure strips</b> • PH-Mess-Sreifen <b>• Tira medición pH • pH ölçü şeritleri</b> <b>• Ταβλιές μέτρησης pH</b>

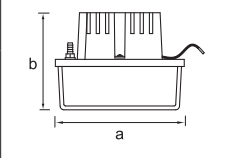

## ACCESSORIES

ZUB

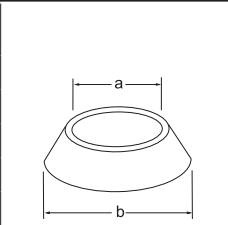

ZUBEHÖR  
ACCESORIOS  
AKSESUARLAR  
ΕΞΑΡΤΗΜΑΤΑ

<b>ZUB Condensate outlet pump</b> ZUB Förderpumpe • ZUB Bomba condensados • ZUB Kondens çikis pompası • ZUB Αντλία όξινων συμπυκνωμάτων										
			Code Código	Kod Κωδ.	a (mm)	b (mm)	c (mm)	d (mm)	e (mm)	
-			ZUFP00		260	175	-	-	-	Max. to 4,5 m Bis max. 4,5 Meter Hasta max. 4,5m Maks. 4,5 m Μέγιστο έως 4,5 m



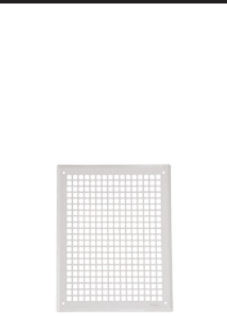
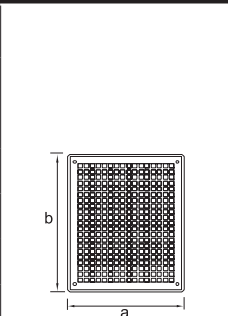

<b>ZUB Wall rose</b> ZUB Wandrosette • ZUB Junta tapamuros • ZUB Duvar Gülü • ZUB Ροζέτα										
		Ø	Code Código	Kod Κωδ.	a (mm)	b (mm)	c (mm)	d (mm)	e (mm)	
		60	UPRKW4		60	105	-	-	-	white weiss blanco beyaz Λευκή
		80	UPRKW7		80	145	-	-	-	
		100	UPRKW5		100	165	-	-	-	
		125	UPRKW8		125	225	-	-	-	
		80	UPRKS7		80	145	-	-	-	black schwarz negro siyah Μαύρη
		100	UPRKS5		100	165	-	-	-	
		125	UPRKS8		125	225	-	-	-	

<b>ZUB Ventilation grill</b> ZUB Lüftungsgitter universal • ZUB Remate mural ventilado univ. • ZUB Havalandırma izgarası • ZUB Γρίλια εξαερισμού										
			Code Código	Kod Κωδ.	a (mm)	b (mm)	c (mm)	d (mm)	e (mm)	
		-	ZULG00		270	340	-	-	-	Stainless steel Edelstahl • Acero inoxidable • Paslanmaz çelik • Ανοξείδωτος χάλυβας
		-	TTLG01		150	150	-	-	-	Aluminium Aluminium Aluminio Alüminyum Αλουμίνιο
		-	TTLG02		150	300	-	-	-	
		-	TTLG03		300	300	-	-	-	
		-	TTLG04		150	150	-	-	-	Stainless steel Edelstahl • Acero inoxidable • Paslanmaz çelik • Ανοξείδωτος χάλυβας
		-	TTLG05		150	300	-	-	-	Rain protection Regenschutz • Protección contra lluvia • Yağmur koruması • Προστασία από βροχή

<b>ZUB Back ventilation grill</b> ZUB Abdeckblende m. Hinterlüftung • ZUB Remate cubretubo ventilado • ZUB Arka havalandırma izgarası • ZUB Γρίλια αερισμού										
		Ø	Code Código	Kod Κωδ.	a (mm)	b (mm)	c (mm)	d (mm)	e (mm)	
		60	ZUBL05		270	340	-	-	-	
		75	ZUBL07		270	340	-	-	-	
		80	ZUBL08		270	340	-	-	-	
		90	ZUBL09		270	340	-	-	-	
		110	ZUBL01		270	340	-	-	-	
		125	ZUBL02		270	340	-	-	-	
		140	ZUBL04		270	340	-	-	-	
		160	ZUBL06		270	340	-	-	-	
		200	ZUBL00		-	-	-	-	-	
		250	ZUBL0V		-	-	-	-	-	

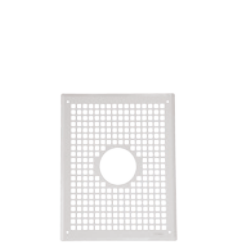
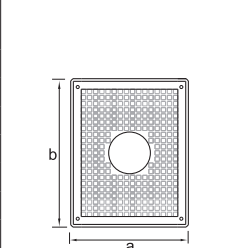
ZUB

ZUBEHÖR  
ACCESORIOS  
AKSESUARLAR  
ΕΞΑΡΤΗΜΑΤΑ

## ZUB Inspection door

ZUB Revisionsstüre • ZUB Puerta de inspección • ZUB Muayene kapısı • ZUB Θυρίδα επιθεώρησης

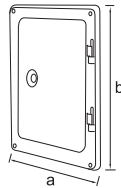
			Code	Kod	a (mm)	b (mm)	c (mm)	d (mm)	e (mm)	i
			Código	Κωδ.						
		-	TTAD01		280	410	-	-	-	white weiss • blanco • beyaz • Λευκό χρώμα
		-	TTAD02		280	410	-	-	-	Stainless steel Edelstahl • Acero inoxidable • Paslanmaz çelik • Ανοξείδιωτος χάλυβας
		-	TTAD03		155	305	-	-	-	white weiss • blanco • beyaz • Λευκό χρώμα
		-	TTAD04		155	305	-	-	-	Stainless steel Edelstahl • Acero inoxidable • Paslanmaz çelik • Ανοξείδιωτος χάλυβας

## ZUB Clamp with rubber

ZUB Klemme mit Gummi • ZUB Abrazadera con goma • Kauçuk ile ZUB Kelerçe • ZUB Σφικτήρας με λάστιχο

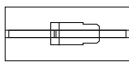
		Ø	Code	Kod	a (mm)	b (mm)	c (mm)	d (mm)	e (mm)	i
			Código	Κωδ.						
		60/100	ALKLL5		-	-	-	-	-	
		80/125	ALKLL8		-	-	-	-	-	
		-	-		-	-	-	-	-	



## STARR Seal

STARR Muffendichtung • STARR Junta manguito • STARR Mühür • STARR Δακτύλιος

		Ø	Code	Kod	a (mm)	b (mm)	c (mm)	d (mm)	e (mm)	i							
			Código	Κωδ.													
		60	ZUMDE5								-	-	-	-	-	-	EPDM material Material EPDM Material EPDM EPDM materyal Υλικό EPDM
		80	ZUMDE8								-	-	-	-	-		
		100	ZUMDEX								-	-	-	-	-		
		110	ZUMDE1								-	-	-	-	-		
		125	ZUMDE2								-	-	-	-	-		
		160	ZUMDE6								-	-	-	-	-		
		200	ZUMDE0								-	-	-	-	-		
		250	ZUMDEV								-	-	-	-	-		
315	ZUMDE3		-	-	-	-	-										

## FLEX Seal for bayonet closure

FLEX Dichtung Bajonett-Verschluss • FLEX Junta cierre de bayoneta • Bayonet kapatma için FLEX Seal • FLEX Δακτύλιος

		Ø	Code	Kod	a (mm)	b (mm)	c (mm)	d (mm)	e (mm)	i
			Código	Κωδ.						
		60	ZUMDF5		66	-	-	-	-	
		80	ZUMDF8		86	-	-	-	-	
		100	ZUMDFX		106	-	-	-	-	
		125	ZUMDF2		132	-	-	-	-	
		-	-		-	-	-	-	-	

ZUB

## ACCESSORIES

ZUB

ZUBEHÖR

ACCESORIOS

AKSESUARLAR

ΕΞΑΡΤΗΜΑΤΑ

<b>ZUB Seal (concentric external pipe)</b> ZUB Dichtung (konzentrisch Aussenrohr) • ZUB Junta (tubo exterior concéntrico) • ZUB Conta (eş merkezli dış boru) • ZUB Δακτύλιος ομοκεντρικών (εξωτερικός σωλήνας)										
		Ø	Code Código	Kod Κωδ.	a (mm)	b (mm)	c (mm)	d (mm)	e (mm)	i
	LIB/LIL	100	ZULDN5		-	-	-	-	-	EPDM material Material EPDM Material EPDM
		125	ZULDN8		-	-	-	-	-	
		150	ZULDNX		-	-	-	-	-	
	LIK	100	ZULDK5		-	-	-	-	-	EPDM material Υλικό EPDM
		125	ZULDK8		-	-	-	-	-	

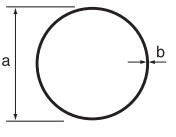
<b>ZUB "O"-ring</b> ZUB „O“-Ring • ZUB Junta tórica • ZUB „O“-ring halkası • ZUB Δακτύλιος "O"-ring										
		Ø	Code Código	Kod Κωδ.	a (mm)	b (mm)	c (mm)	d (mm)	e (mm)	i
		60	ZUORE5		68	5	-	-	-	EPDM material Material EPDM Material EPDM EPDM material Υλικό EPDM
		80	ZUORE8		72	5	-	-	-	
		110	ZUORE1		105	5	-	-	-	
		125	ZUORE2		120	5	-	-	-	
		160	ZUORE6		150	5	-	-	-	

<b>ZUB „O“-ring for measure piece</b> ZUB Schlauchtülle • ZUB Junta tórica pr. tm./muestras • Ölçü parçası için ZUB „O“-ring halkası • ZUB Δακτύλιος "O"-ring για σημείο μέτρησης										
		Ø	Code Código	Kod Κωδ.	a (mm)	b (mm)	c (mm)	d (mm)	e (mm)	i
		16	ZUST16		-	-	-	-	-	EPDM material Material EPDM Material EPDM EPDM material Υλικό EPDM
		20	ZUST20		-	-	-	-	-	
		40	ZUST40		-	-	-	-	-	

ZUB

**DoP, Chimney tag EU****Declaration of performance****Chimney tag EU**

**Leistungserklärung, Kaminaufkleber**

**Leistungserklärung**



**Kaminaufkleber**

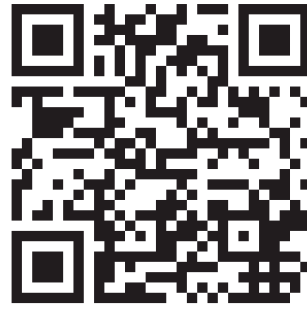

**Declaración de conformidad - Etiqueta de chimenea UE**

**Declaración de  
conformidad**



**Etiqueta de  
chimenea UE**



**Performans beyanı, Baca etiketi AB**

(imalatçı firma web sitesi)

**Performans beyanı**

(imalatçı firma web sitesi)

**Baca etiketi AB**

(imalatçı firma web sitesi)



**Πιστοποιητικά, Ετικέτα καπνοδόχου**  
(ιστοσελίδα κατασκευαστή)

**Πιστοποιητικά**  
(ιστοσελίδα κατασκευαστή)



**Ετικέτα καπνοδόχου**  
(ιστοσελίδα κατασκευαστή)



Notifizierte Stelle  
Nr. 0036



Industrie Service

## Zertifikat der Konformität der werkseigenen Produktionskontrolle

0036 CPR 9165 001  
Revision 02

Gemäß der Verordnung (EU) Nr. 305/2011 des Europäischen Parlaments und des Rates vom 9. März 2011 (Bauproduktenverordnung - CPR) gilt dieses Zertifikat für das Bauprodukt

### System-Abgasanlage Typ ALMEVA mit einer Innenschale aus starren Rohren und Formstücken aus PP Ausführungen

ohne Außenschale		
Easy ab DN 200	EN 14471	T120 P1 W2 O20 LI E U
Easy bis DN 160	EN 14471	T120 H1 W2 O20 LI E U
mit Kunststoffaußenschale		
Double ab DN 200	EN 14471	T120 P1 W2 O00 LI E U1
Double bis DN 160	EN 14471	T120 H1 W2 O00 LI E U1
mit metall. Außenschale		
Double LI. ab DN 200	EN 14471	T120 P1 W2 O00 LI E U0
Double LI. bis DN 160	EN 14471	T120 H1 W2 O00 LI E U0
Double LA. ab DN 200	EN 14471	T120 P1 W2 O00 LE E U0
Double LA. bis DN 160	EN 14471	T120 H1 W2 O00 LE E U0
mit mineral. Außenschale		
Schacht ab DN 200	EN 14471	T120 P1 W2 O00 LI E U0
Schacht bis DN 160	EN 14471	T120 H1 W2 O00 LI E U0

hergestellt von

**Almeva AG**  
Industriestrasse 6  
CH-9220 Bischofszell

im Herstellwerk

Industriestr. 6  
CH-9220 Bischofszell

Dieses Zertifikat bescheinigt, dass alle Vorschriften über die Bewertung und Überprüfung der Leistungsbeständigkeit beschrieben im Anhang ZA der harmonisierten Norm

**EN 14471:2013+A1:2015**

entsprechend System 2+ angewendet werden und dass die werkseigene Produktionskontrolle alle darin vorgeschriebenen Anforderungen erfüllt.

Die Feststellung des Produkt-Typs anhand einer Typprüfung ist dokumentiert im Bericht: TÜV SÜD Industrie Service GmbH, A 1661-01/08 und A 1661-02/16.

Dieses Zertifikat wurde erstmals am 2008-03-15 ausgestellt und bleibt gültig, solange sich die in der harmonisierten Norm genannten Prüfverfahren und/oder Anforderungen der werkseigenen Produktionskontrolle zur Bewertung der Leistung der erklärten Merkmale nicht ändern und das Produkt und die Herstellbedingungen im Werk nicht wesentlich geändert werden.

München, 2016-07-06

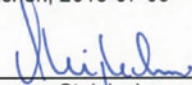
  
Johannes Steiglechner  
Leiter Zertifizierungsstelle Bauprodukte (EG)

TÜV SÜD INDUSTRIE SERVICE GMBH, WESTENDSTRASSE 199, 80686 MÜNCHEN

TÜV®







**SAPI**   
KAMIN-SYSTEM

**SAPI KAMIN-SYSTEM**

Schüttelstraße 71

1020 Wien

Österreich

+43 650 367 18 58

office@sapi-kamin.at

www.sapi-kamin.at

CATALOGUE | KATALOG | CATÁLOGO | KATALOG | ΚΑΤΑΛΟΓΟΣ

**PARTNER**

